



Operation Manual

Solenoid Valve

PRODUCT NAME

VQC4000Series
(Pilot Valve:V100)

MODEL / Series / Product Number

SMC Corporation

Contents

Safety Instructions	2,3
Design / Selection	4 to 6
Mounting	6
Piping	6
Wiring	7
Lubrication	7
Air Supply	7
Operating Environment	8
Maintenance	8
Specific Product Precautions	9,10
Manifold option / Assembly Part No.....	11
Construction	12
List of valves,options,and Mounting Bolts.....	13
Electrical Wiring Specifications.....	14 to 18
● F kit	14
● P kit	15
● T kit	16
● L kit	17
● M kit	18
Trouble shooting	19,20



Safety Instructions

These safety instructions are intended to prevent hazardous situations and/or equipment damage. These instructions indicate the level of potential hazard with the labels of "Caution," "Warning" or "Danger." They are all important notes for safety and must be followed in addition to International Standards (ISO/IEC)*1), and other safety regulations.

*1) ISO 4414: Pneumatic fluid power -- General rules relating to systems.

ISO 4413: Hydraulic fluid power -- General rules relating to systems.

IEC 60204-1: Safety of machinery -- Electrical equipment of machines .(Part 1: General requirements)

ISO 10218: Manipulating industrial robots -Safety.

etc.



Caution

Caution indicates a hazard with a low level of risk which, if not avoided, could result in minor or moderate injury.



Warning

Warning indicates a hazard with a medium level of risk which, if not avoided, could result in death or serious injury.



Danger

Danger indicates a hazard with a high level of risk which, if not avoided, will result in death or serious injury.

Warning

1. The compatibility of the product is the responsibility of the person who designs the equipment or decides its specifications.

Since the product specified here is used under various operating conditions, its compatibility with specific equipment must be decided by the person who designs the equipment or decides its specifications based on necessary analysis and test results.

The expected performance and safety assurance of the equipment will be the responsibility of the person who has determined its compatibility with the product.

This person should also continuously review all specifications of the product referring to its latest catalog information, with a view to giving due consideration to any possibility of equipment failure when configuring the equipment.

2. Only personnel with appropriate training should operate machinery and equipment.

The product specified here may become unsafe if handled incorrectly.

The assembly, operation and maintenance of machines or equipment including our products must be performed by an operator who is appropriately trained and experienced.

3. Do not service or attempt to remove product and machinery/equipment until safety is confirmed.

1. The inspection and maintenance of machinery/equipment should only be performed after measures to prevent falling or runaway of the driven objects have been confirmed.

2. When the product is to be removed, confirm that the safety measures as mentioned above are implemented and the power from any appropriate source is cut, and read and understand the specific product precautions of all relevant products carefully.

3. Before machinery/equipment is restarted, take measures to prevent unexpected operation and malfunction.

4. Contact SMC beforehand and take special consideration of safety measures if the product is to be used in any of the following conditions.

1. Conditions and environments outside of the given specifications, or use outdoors or in a place exposed to direct sunlight.

2. Installation on equipment in conjunction with atomic energy, railways, air navigation, space, shipping, vehicles, military, medical treatment, combustion and recreation, or equipment in contact with food and beverages, emergency stop circuits, clutch and brake circuits in press applications, safety equipment or other applications unsuitable for the standard specifications described in the product catalog.

3. An application which could have negative effects on people, property, or animals requiring special safety analysis.

4. Use in an interlock circuit, which requires the provision of double interlock for possible failure by using a mechanical protective function, and periodical checks to confirm proper operation.



Safety Instructions

Caution

The product is provided for use in manufacturing industries.

The product herein described is basically provided for peaceful use in manufacturing industries.

If considering using the product in other industries, consult SMC beforehand and exchange specifications or a contract if necessary.

If anything is unclear, contact your nearest sales branch.

Limited warranty and Disclaimer/Compliance Requirements

The product used is subject to the following “Limited warranty and Disclaimer” and “Compliance Requirements”.

Read and accept them before using the product.

Limited warranty and Disclaimer

1. The warranty period of the product is 1 year in service or 1.5 years after the product is delivered, whichever is first.*2)

Also, the product may have specified durability, running distance or replacement parts. Please consult your nearest sales branch.

2. For any failure or damage reported within the warranty period which is clearly our responsibility, a replacement product or necessary parts will be provided.

This limited warranty applies only to our product independently, and not to any other damage incurred due to the failure of the product.

3. Prior to using SMC products, please read and understand the warranty terms and disclaimers noted in the specified catalog for the particular products.

*2) Vacuum pads are excluded from this 1 year warranty.

A vacuum pad is a consumable part, so it is warranted for a year after it is delivered.

Also, even within the warranty period, the wear of a product due to the use of the vacuum pad or failure due to the deterioration of rubber material are not covered by the limited warranty.

Compliance Requirements

1. The use of SMC products with production equipment for the manufacture of weapons of mass destruction(WMD) or any other weapon is strictly prohibited.

2. The exports of SMC products or technology from one country to another are governed by the relevant security laws and regulation of the countries involved in the transaction. Prior to the shipment of a SMC product to another country, assure that all local rules governing that export are known and followed.

Caution

SMC products are not intended for use as instruments for legal metrology.

Measurement instruments that SMC manufactures or sells have not been qualified by type approval tests relevant to the metrology (measurement) laws of each country.

Therefore, SMC products cannot be used for business or certification ordained by the metrology (measurement) laws of each country.



Precautions for 5 Port Solenoid Valve 1

Be sure to read before handling. Refer to main text for detailed precautions on every series.

Design / Selection

Warning

1. Confirm the specifications

Products represented in this catalog are designed only for use in compressed air systems (including vacuum). Do not operate at pressures or temperatures, etc., beyond the range of specifications, as this can cause damage or malfunction. (Refer to the specifications.) Please contact SMC when using a fluid other than compressed air (including vacuum).

We do not guarantee against any damage if the product is used outside of the specification range.

2. Actuator drive

When an actuator, such as a cylinder, is to be driven using a valve, take appropriate measures (cover installation or approach prohibition) to prevent potential danger caused by actuator operation.

3. Intermediate stops

For 3-position closed center or double check valve type, it is difficult to make a piston stop at the required position accurately due to the compressibility of air. Furthermore, since valves and cylinders are not guaranteed for zero air leakage, it may not be possible to hold a stopped position for an extended period of time. Please contact SMC if it is necessary to hold a stopped position for an extended period of time.

4. Effect of back pressure when using a manifold.

Use caution when valves are used on a manifold, because an actuator may malfunction due to back-pressure. For 3-position exhaust center valve of single acting cylinder, take appropriate measures to prevent the malfunction by using it with an individual exhaust spacer.

5. Holding pressure (including vacuum).

Since the valve are subject to air leakage, they cannot be used for applications such as holding pressure (including vacuum) in a pressure vessel.

6. Not suitable for use as an emergency shut-off valve, etc.

The valves listed in this instruction manual are not designed for safety applications such as an emergency shutoff valve. If the valves are used for the mentioned applications, additional safety measures should be adopted.

7. Release of residual pressure

For maintenance purposes install a system for releasing residual pressure. Especially in the case of 3-position closed center valve or double check valve type, ensure that the residual pressure between the valve and the cylinder is released.

8. Operation in a vacuum condition

When a valve is used for switching a vacuum, take measures to install a suction filter or similar to prevent external dust or other foreign matter from entering inside the valve. In addition, at the time of vacuum adsorption, be sure to supply a constant supply of vacuum. Failure to do so may result in foreign matter sticking to the adsorption pad or air leakage, causing the workpiece to drop.

9. Regarding vacuum switch valves and vacuum release valves

If a non-vacuum valve is installed in the middle of a piping system that contains a vacuum, the vacuum condition will not be maintained. Use a valve designed for use under vacuum conditions.

10. Double solenoid type

When using the double solenoid type for the first time, actuators may travel in an unexpected direction depending on the switching position of the valve. Implement measures to prevent any danger from occurring when operating the actuator.

11. Ventilation

Provide ventilation when using a valve in a confined area, such as in a closed control panel. For example, install a ventilation opening, etc. in order to prevent pressure from increasing inside of the confined area and to release the heat generated by the valve.

12. Extended periods of continuous energization

· If a valve will be continuously energized for an extended period of time, the temperature of the valve will increase due to the heat generated by the coil. This will likely adversely affect the performance of the solenoid valve and any nearby peripheral equipment. Therefore, when it is continuously energized or the energized period per day is longer than the de-energized period use either: DC specification, power-saving type. Also, please contact SMC because depending on the application, there may be additional valves not mentioned above that may be used.

· For applications such as mounting a valve on a control panel, incorporate measure to limit the heat radiation so that it is within the operation temperature range. For example, the temperature will be high when a 3 station manifold.

13. Do not disassemble the product of make any modifications, including additional machining.

It may cause human injury and/or an accident.

14. Resumption after a long period of holding time

When resuming operation after a long period of holding time, there are cases in which, regardless of whether the product is in an ON or OFF state, there is a delay in the initial response time due to adhesion. Conducting several cycles of running-in operation will solve this problem. Please consider implementing this before resumption.



Precautions for 5 Port Solenoid Valve 2

Be sure to read before handling. Refer to main text for detailed precautions on every series.

Design / Selection

Caution

1. Precautions on 2-position double solenoid valve

If a double solenoid valve is operated with momentary energization, it should be energized for at least 0.1 second. However, depending on the piping conditions, cylinder may malfunction even when the double solenoid valve is energized for 0.1 second or longer. In this case, energize the double solenoid valve until the cylinder is exhausted completely.

2. Leakage voltage

Take note that the leakage voltage will increase when a resistor is used in parallel with switching element or a C-R circuit (surge voltage suppressor) is used for protecting a switching device because of the passing leakage voltage through the C-R circuit. The suppressor residual leakage voltage should be as follows. Should be 3% or less of rated voltage.

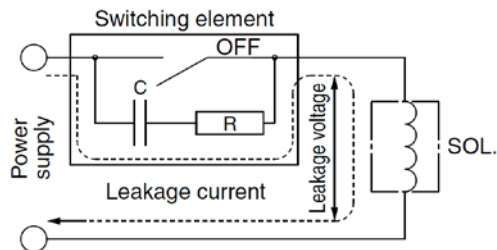

3. Surge voltage suppressor

- 1) A surge voltage suppressor built into the valve is intended to protect the output contacts so that the surge generated inside valve does not adversely affect the output contacts. Therefore, if an overvoltage or overcurrent is received from an external peripheral device, the surge voltage protection element inside the valve is overloaded, causing the element to break. In the worst case, the electric circuit enters the short-circuit status by the breakage. If the energizing continues in this status, a large current flows. This may cause secondary damage to the output circuit, external peripheral device, or valve, and may also cause fire accident. So, take appropriate protective measures, such as installation of an overcurrent protection circuit in the power supply or drive circuit to maintain the sufficient safety.
- 2) If a surge protection circuit contains nonstandard diodes, such as Zener diodes or varistor, a residual voltage that is in proportion to the protective circuit and the rated voltage will remain. Therefore, take into consideration the surge voltage protection of the controller. In the case of diodes, the residual voltage is approximately 1 V.

4. Surge voltage intrusion

With non-polar type solenoid valves, at times of sudden interruption of the loading power supply, such as emergency shutdown, surge voltage intrusion may be generated from loading equipment with a large capacity (power consumption), and the solenoid valve in a deenergized state may switch over (see Figure 1).

When installing a breaker circuit for the loading power supply, consider using a solenoid valve with polarity (with polarity protection diode), or install a surge absorption diode between the loading equipment COM line and the output equipment COM line (see Figure 2).

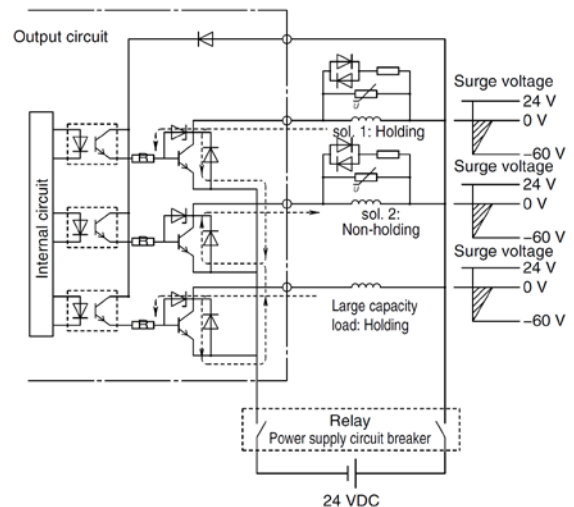

Figure 1. Surge intrusion circuit example (NPN outlet example)

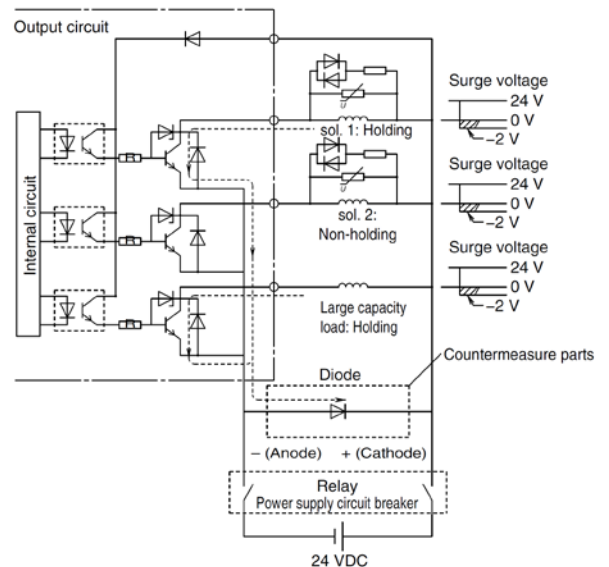

Figure 2. Surge intrusion countermeasure example (NPN outlet example)



Precautions for 5 Port Solenoid Valve 3

Be sure to read before handling. Refer to main text for detailed precautions on every series.

Design / Selection

⚠ Caution

5. Operation in a low temperature condition

It is possible to operate a valve in extreme temperature, as low as -10 °C. Take appropriate measures to avoid freezing of drainage, moisture etc. in low temperature.

6. Operation for air blowing

When using a solenoid valve for air blowing, use an external pilot type. Use caution because the pressure drop caused by the air blowing can have an affect on the internal pilot type valve when the internal pilot type valves and external pilot type valves are used on the same manifold.

Additionally, when compressed air within the pressure range of the established specifications is supplied to the external pilot type valve's port, and a double solenoid valve is used for air blowing, the solenoids should normally be energized when air is being blown.

7. Mounting orientation

Rubber seal : Mounting orientation is free.

Metal seal : Mounting orientation of a single solenoid is universal.No specific orientation is necessary. When installing a double solenoid or a 3-position configuration, mount the valve so that spool valve is horizontal.

8. Initial lubrication of main valve

The following initial lubricant has already been applied to the main valve.

- Rubber seal, spool valve: Grease Please consult with SMC, as there are some standard valve products that use fluorine grease for food processing equipment (NSF H-1).
- Metal seal, spool valve: Turbine oil Turbine oil is applied to the spool valve of a metal seal type. Therefore, turbine oil may seep out when a new product is delivered, or while the valve is stored.

9. For the pilot EXH(PE) port

If the solenoid valve and the manifold's pilot EXH (PE) port is restricted extremely or blocked, abnormal operation of the solenoid valve may occur.

Mounting

⚠ Warning

1. Operation manual

Install the products and operate them only after reading the operation manual carefully and understanding its contents. Also, keep the manual where it can be referred to as necessary.

2. Ensure sufficient space for maintenance activities.

When installing the products, allow access for maintenance.

3. Tighten threads with the proper tightening torque.

When installing the products, follow the listed torque specifications.

4. If air leakage increases or equipment does not operated properly, stop operation.

Check mounting conditions when air and power supplies are connected. Initial function and leakage tests should be performed after installation.

5. Painting and coating

Warnings or specifications printed or affixed to the product should not be erased, removed or covered up. Please consult with SMC before applying paint to resinous parts, as this may have an adverse effect due to the solvent in the paint.

Piping

⚠ Caution

1. Refer to the Fittings and Tubing Precautions for handling one-touch fittings.

2. Preparation before piping

Before piping is connected, it should be thoroughly blown out with air (flushing) or washed to remove chips, cutting oil and other debris from inside the pipe.

3. Wrapping of pipe tape

When screwing piping or fittings into ports, ensure that chips from the pipe threads or sealing material do not enter the piping. Also, if pipe tape is used, leave 1 thread ridges exposed at the end of the threads.

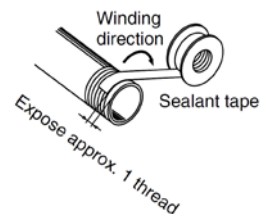

4. Closed center and double check valve types

For closed center or double check valve types, check the piping to prevent air leakage from the piping between the valve and the cylinder.

5. Connection of piping and fittings

When screwing piping or fittings into the valves, tighten them as follows.

- Excessive tightening may damage the thread portion or deform the gasket and cause air leakage. Insufficient tightening may loosen the threads or cause air leakage.
- When using a fitting other than an SMC fitting, follow the instructions given by the fitting manufacturer. For the tightening torque, refer to the table below.

Connection thread size (Rc)	Proper tightening torque (N·m)
1/8	3 to 5
1/4	8 to 12
3/8	15 to 20
1/2	20 to 25

6. Piping to products

When piping to a product, refer to the operation manual to avoid mistakes regarding the supply port, etc.



Precautions for 5 Port Solenoid Valve 4

Be sure to read before handling. Refer to main text for detailed precautions on every series.

Wiring

Warning

1. **The solenoid valve is an electrical product. For safety, install an appropriate fuse and circuit breaker before use.**

Caution

1. Applied voltage

When electric power is connected to a solenoid valve, be careful to apply the proper voltage. Improper voltage may cause malfunction or coil damage.

2. Check the connections

Check if the connections are correct after completing all wiring.

3. External force applied to the lead wire

If an excessive force is applied to the lead wire, this may cause faulty wiring. Take appropriate measures so that a force of 30 N or more is not applied to the lead wire. When instructions are given in the Specific Product Precautions, follow these specifications.

Lubrication

Warning

1. Lubrication

[Rubber seal]

- 1) These valves can be used without lubrication.
- 2) If a lubricant is used in the system, use class 1 turbine oil (no additive), ISO VG32. For details about lubricant manufacturers' brands, refer to SMC website.
Additionally, please contact SMC for details about class 2 turbine oil (with additives) ISO VG32. Once lubricant is utilized within the system, since the original lubricant applied within the product during manufacturing will be washed away, please continue to supply lubrication to the system. Without continued lubrication, malfunctions could occur.
If turbine oil is used, refer to the Safety Data Sheet (SDS) of the oil.

[Metal seal]

- 1) These valves can be used without lubrication.
- 2) If a lubricant is used in the system, use class 1 turbine oil (no additive), ISO VG32. For details about lubricant manufacturers' brands, refer to SMC website.
Additionally, please contact SMC for details about class 2 turbine oil (with additives) ISO VG32.

2. Lubrication amount

If the lubrication amount is excessive, the oil may accumulate inside the pilot valve, causing malfunction or response delay. So, do not apply a large amount of oil. When a large amount of oil needs to be applied, use an external pilot type to put the supply air on the pilot valve side in the non-lube state. This prevents accumulation of oil inside the pilot valve.

Air Supply

Warning

1. Type of fluids

Please consult with SMC when using the product in applications other than compressed air.

2. When there is a large amount of drainage.

Compressed air containing a large amount of drainage can cause the malfunction of pneumatic equipment. An air dryer or water separator should be installed upstream from filters.

3. Drain flushing

If condensation in the drain bowl is not emptied on a regular basis, the bowl will overflow and allow the condensation to enter the compressed air lines. It causes malfunction of pneumatic equipment. If the drain bowl is difficult to check and remove, installation of a drain bowl with an auto drain option is recommended.

For compressed air quality, refer to SMC's Best Pneumatics catalog.

4. Use clean air

Do not use compressed air that contains chemicals, synthetic oils including organic solvents, salt or corrosive gasses, etc., as it can cause damage or malfunction.

Caution

1. When extremely dry air is used as the fluid, degradation of the lubrication properties inside the equipment may occur, resulting in reduced reliability (or reduced service life) of the equipment. Please consult with SMC.

2. Install an air filter.

Install an air filter upstream near the valve. Select an air filter with a filtration size of 5 µm or smaller.

3. Take measures to ensure air quality, such as by installing an aftercooler, air dryer, or water separator.

Compressed air that contains a large amount of drainage can cause the malfunction of pneumatic equipment, such as valves. Therefore, take appropriate measures to ensure air quality, such as by providing an aftercooler, air dryer, or water separator.

4. If an excessive amount of carbon powder is present, install a mist separator on the upstream side of the valve.

If excessive carbon dust is generated by the compressor, it may adhere to the inside of a valve and cause it to malfunction.

For compressed air quality, refer to SMC's Best Pneumatics catalog.



VQC4000 Series

Precautions for 5 Port Solenoid Valve 5

Be sure to read before handling. Refer to main text for detailed precautions on every series.

Operating Environment

Warning

1. Do not use in an atmosphere having corrosive gases, chemicals, sea water, water, water steam, or where there is direct contact with any of these .
2. Products with IP65 and IP67 enclosures (based on IEC60529) are protected against dust and water. However, these products cannot be used in water. however, these products cannot be used in water.
3. Products compliant with IP65 and IP67 satisfy the product specifications when mounted properly. Be sure to read the precautions for each product.
4. Do not use in an environment where flammable gas or explosive gas exists. Usage may cause a fire or explosion. The products do not have an explosion proof construction.
5. Do not use in a place subject to heavy vibration and/or shock.
6. The valve should not be exposed to prolonged sunlight. Use a protective cover. Note that the valve is not for outdoor use.
7. Remove any sources of excessive heat.
8. If it is used in an environment where there is possible contact with oil, weld spatter, etc., exercise preventive measures.
9. When the solenoid valve is mounted in a control panel or it's energized for a long period of time, make sure the ambient temperature is within the specifications of the valve.

Caution

1. **Temperature of ambient environment**
Use the valve within the range of the ambient temperature specification of each valve. In addition, pay attention when using the valve in environments where the temperature changes drastically.
2. **Humidity of ambient environment**
 - When using the valve in environments with low humidity, take measures to prevent static.
 - If the humidity rises, take measures to prevent the adhesion of water droplets on the valve.

Maintenance

Warning

1. **Perform maintenance inspection according to the procedures indicated in the operation manual.**
If handled improperly, human injury and/or malfunction or damage of machinery and equipment may occur.
2. **Removal of equipment, and supply/exhaust of compressed air**
Before components are removed, first confirm that measures are in place to prevent workpieces from dropping, run-away equipment, etc. Then, cut off the supply air and electric power, and exhaust all air pressure from the system using the residual pressure release function.
For 3-position closed center type, exhaust the residual pressure between the valve and the actuator. When the equipment is operated after remounting or replacement, first confirm that measures are in place to prevent lurching of actuators, etc. Then, confirm that the equipment is operating normally.
In particular, when a 2-position double solenoid valve is used, releasing residual pressure rapidly may cause the spool valve to malfunction, depending on the piping conditions, or the connected actuator to operate.
3. **Low frequency operation**
Valves should be operated at least once every 30 days to prevent malfunction. (Use caution regarding the air supply.)
4. **Manual override**
When a manual override is operated, connected equipment will be actuated. Operate only after safety is confirmed.
5. **If the volume of air leakage increases or the valve does not operate normally, do not use the valve. Perform periodic maintenance on the valve to confirm the operating condition and check for any air leakage.**

Caution

1. **Drain flushing**
Remove drainage from the air filters regularly.
2. **Lubrication**
In the case of rubber seals, once lubrication has been started, it must be continued.
Use class 1 turbine oil (with no additives), VG32. If other lubricant oil is used, it may cause a malfunction. Please contact SMC for information on the suggested class 2 turbine oil (with additives), VG32.
3. **Manual override operation**
When switching a double solenoid valve via the manual override operation, instantaneous operation may cause the malfunction of the cylinder. It is recommended that the manual override be held until the cylinder reaches the stroke end position.



VQC4000 Series

Specific Product Precautions 1

Be sure to read before handling. Refer to main text for detailed precautions on every series.

Continuous Duty

⚠ Warning

When the product is continuously energized for a long period of time (10 minutes or longer), select the low wattage type (DC specification).

Manual Override

⚠ Warning

Since connected equipment will operate when the manual override is activated, confirm that conditions are safe prior to activation.

■ Push type (Tool required)

Push down the manual override button with a small screwdriver, etc., until it stops. The manual override will return when released.

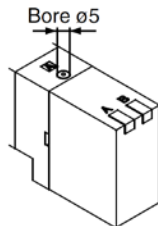

■ Locking type (Tool required)

Push down the manual override button with a small flat head screwdriver until it stops, and turn it clockwise 90° to lock it. Turn it counterclockwise to release it.

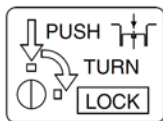
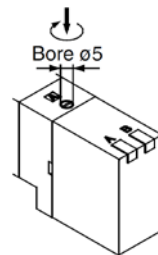

■ Locking type (Manual)

Push down the manual override button with a small flat head screwdriver or with your finger until it stops, and turn it clockwise 90° to lock it. Turn it counterclockwise to release it.

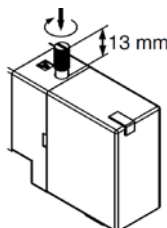
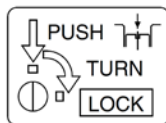

⚠ Caution

Do not apply excessive torque when turning the manual override. [0.1 N·m or less]

Valve Mounting

⚠ Caution

After confirming that the gasket is installed correctly, securely tighten the mounting screws according to the tightening torque shown below.

Proper tightening torque [N·m]
0.8 to 1.2

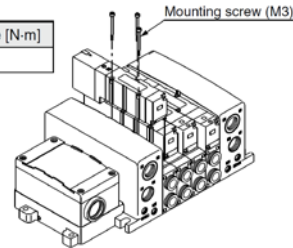

Replacement of One-touch Fittings

⚠ Caution

Cylinder port fittings are available in cassette type and can be replaced easily. Fittings are secured with a retaining clip that is inserted from the top side of the valve. After removing the valve, remove the clip with a flat head screwdriver to replace the fittings. To mount a fitting, insert the fitting assembly until it stops and reinsert the retaining clip to its designated position.

Applicable tube O.D.	Fitting assembly part no. VQC4000
ø6	VVQ4000-50B-C6
ø8	VVQ4000-50B-C8
ø10	VVQ4000-50B-C10
ø12	VVQ4000-50B-C12
ø1/4"	VVQ4000-50B-N7
ø5/16"	VVQ4000-50B-N9
ø3/8"	VVQ4000-50B-N11

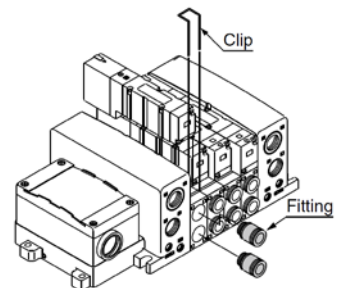

Lead Wire Connection

⚠ Caution

Plug-in sub-plate (With terminal block)

- If the junction cover ① of the sub-plate is removed, you can see the plug-in type terminal block ② mounted inside the sub-plate.
- The terminal block is marked as follows. Connect wiring to each of the power supply terminals.

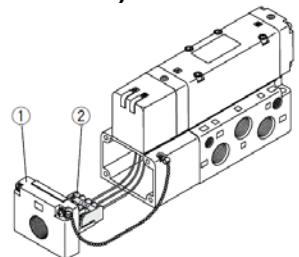

Model	Terminal block marking	A	COM	B	⎓
VQC 410 ⁰ ₁		A side	COM	—	—
VQC 420 ⁰ ₁		A side	COM	B side	—
VQC 4 ³ ₄ ⁰ ₅ ⁰ ₆		A side	COM	B side	—

Note 1) There is no polarity. It can also be used as -COM.

Note 2) The sub-plate is double wired even for the VQC410⁰₁.

- Applicable terminal: 1.25-3s, 1.25Y-3, 1.25Y-3N, 1.25Y-3.5



VQC4000 Series

Specific Product Precautions 2

Be sure to read before handling. Refer to main text for detailed precautions on every series.

Installation and Removal of Light Cover

⚠ Caution

• Removal

Open the cover by inserting a small flat head screwdriver into the slot on the side of the pilot assembly (see drawing below), lift the cover out about 1 mm and then pull off. If it is pulled off at an angle, the pilot valve may be damaged or the protective O-ring may be scratched.

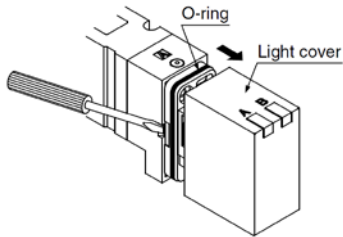

• Installation

Place the cover straight over the pilot assembly so that the pilot valve is not touched, and push it until the cover hook locks without twisting the protective O-ring. (When pushed in, the hook opens and locks automatically.)

Replacement of Pilot Valve

⚠ Caution

• Removal

Remove the mounting screw that holds the pilot valve using a small screwdriver.

• Installation

After confirming the gasket is correctly placed under the valve, securely tighten the bolts with the proper torque shown in the table below.

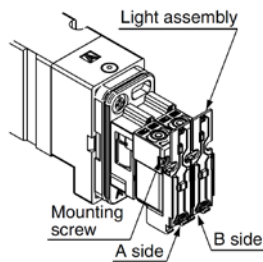

Proper tightening torque [N·m]

0.1 to 0.13

Note) The light circuit boards: A side is orange and the B side is green. It must be mounted on the pilot valve in accordance with the mounting indicators.

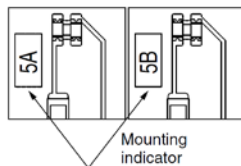

Internal Wiring Specifications

⚠ Caution

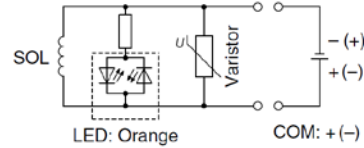

DC: Single

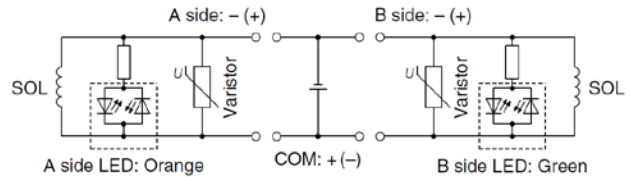

DC: Double

Note) Coil surge voltage generated when OFF is about -60 V. Please contact SMC separately for further suppression of the coil surge voltage.

How to Calculate the Flow Rate

For obtaining the flow rate, refer to the **WEB catalog** or the Best Pneumatics No. 1.

Manifold Options

Blanking plate assembly
VVQ4000-10A-1

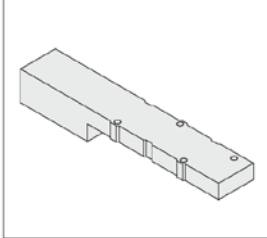

Individual SUP spacer
VVQ4000-P-1-⁰²/₀₃

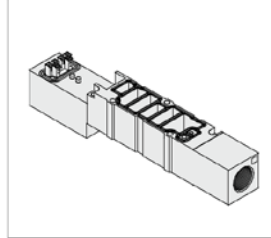

Individual EXH spacer
VVQ4000-R-1-⁰²/₀₃

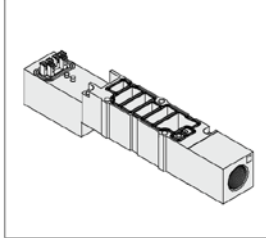

SUP/EXH block plate
VVQ4000-16A (1 pc./set)

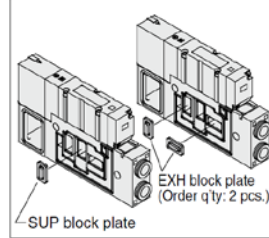

Restrictor spacer
VVQ4000-20A-1

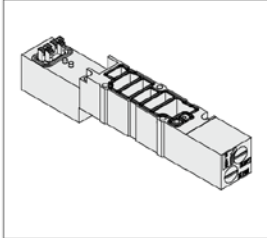

Double check spacer with residual pressure exhaust
VVQ4000-25A-1 ^{Note)}

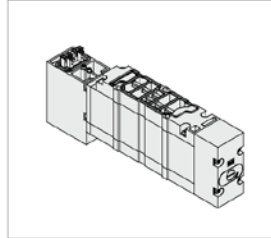

SUP stop valve spacer
VVQ4000-37A-1

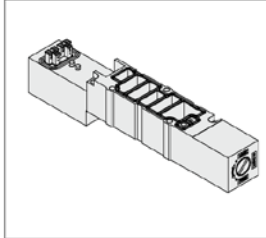

Interface regulator (P, A, B port regulation)
ARBQ4000-00-¹/₂-1

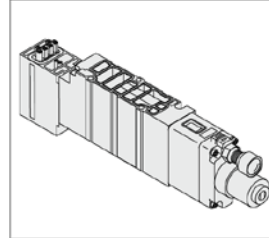

Note) The double check spacer with residual pressure release valve cannot be combined with external pilot type.

Manifold Assembly Part No.

D-side end plate assembly

D-side end plate assembly part no.

VVQC4000-3A-**2** - **□** - **□**

Option

Nil	Standard
S	Built-in silencer, Direct exhaust

Thread type

Nil	Rc
F	G
T	NPTF
N	NPT

Kit type

2	F, P, T, S (EX126, EX250, EX600) kit
3	L, M, S (EX260, EX500) kit

U-side end plate assembly

U-side end plate assembly part no.

VVQC4000-2A-1 - **□** - **□**

Option

Nil	Standard
S	Built-in silencer, Direct exhaust

Thread type

Nil	Rc
F	G
T	NPTF
N	NPT

Manifold block assembly

Manifold block assembly part no.

VVQC4000-1 **A** - **D** - **C6** - **□**

Type

A	For 1 station
C	For 2 stations ^{Note 2)}

Note 1) Tie-rods (2 pcs.) for additional stations included.
Note 2) Bottom ported type is available only for 1 station.

Wiring specifications

D	Double wiring
S	Single wiring ^{Note 3)}

Note 3) Single wiring is available only for 1 station.

Thread type (Thread port only)

Nil	Rc
F	G
T	NPTF
N	NPT

Port size

Symbol	Port size
C6	ø6
C8	ø8
C10	ø10
C12	ø12
N7	ø1/4"
N9	ø5/16"
N11	ø3/8"
O2	1/4"
O3	3/8"
B	1/4" bottom ported

Tie-rod assembly part no. (2 units)

VVQC4000 VVQC4000-TR-**□**

Note 1) Please order when reducing the number of manifold stations. When increasing the number of stations, additional orders are not required since they are included in the manifold block assembly.

Note 2) Number of stations. 02 to 16

Construction

Plug-in Unit

Metal seal type

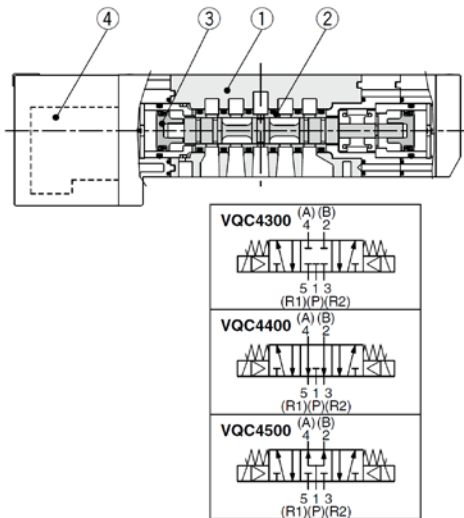
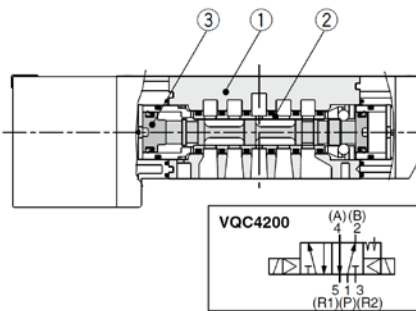
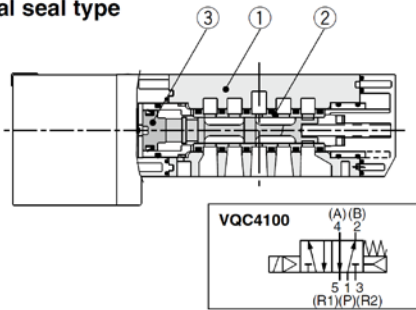

Rubber seal type

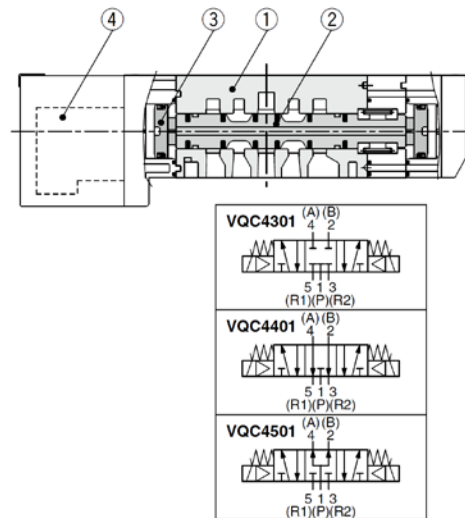
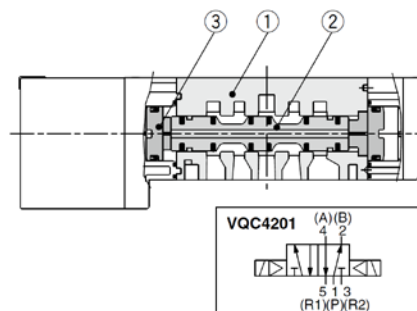
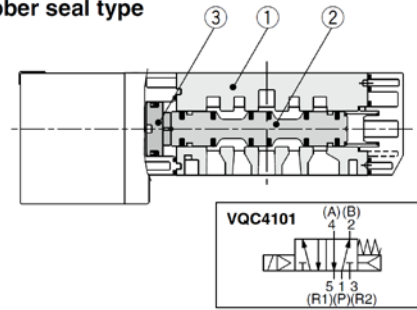

Component Parts

No.	Description	Material	Note
1	Body	Aluminum die-casted	
2	Spool/Sleeve	Stainless steel	
3	Piston	Resin	

Replacement Parts

4	Pilot valve assembly	<p>V118□□□ A B E</p> <p>□: Coil rated voltage Example) 24 VDC: 5 A: With light (For A side) B: With light (For B side) E: Without light (A/B side common)</p> <p>•Coil type Nil Standard (0.95 W) Y Low wattage type (0.4 W)</p>	
---	----------------------	--	--



Component Parts

No.	Description	Material	Note
1	Body	Aluminum die-casted	
2	Spool valve	Aluminum, HNBR	
3	Piston	Resin	

Replacement Parts

4	Pilot valve assembly	<p>V118□□□ A B E</p> <p>□: Coil rated voltage Example) 24 VDC: 5 A: With light (For A side) B: With light (For B side) E: Without light (A/B side common)</p> <p>•Coil type Nil Standard (0.95 W) Y Low wattage type (0.4 W)</p>	
---	----------------------	--	--

List of Valves, Options, and Mounting Bolts

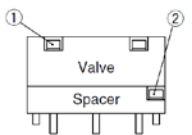
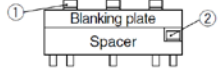
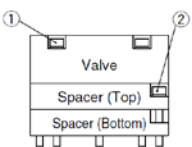
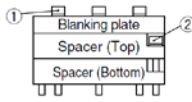
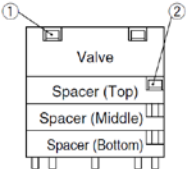
Number of options	Valve and options	Bolt part no.	Qty (pcs.)	Note	Option mounting diagram
0	Single valve	AXT632-17-4 (M3 x 37)	3		
	Blanking plate (VVQ4000-10A- $\frac{1}{5}$)	AXT632-38-1 (M3 x 14)	4	For manifold	
1	Valve + Individual SUP spacer (VVQ4000-P- $\frac{1}{5}$ - $\frac{02}{03}$)	① AXT632-17-10 (M3 x 62)	3	For manifold	
		② AXT632-17-19 (M3 x 26)	2		
	Valve + Individual EXH spacer (VVQ4000-R- $\frac{1}{5}$ - $\frac{02}{03}$)	① AXT632-17-10 (M3 x 62)	3	For manifold	
		② AXT632-17-19 (M3 x 26)	2		
	Valve + Restrictor spacer (VVQ4000-20A- $\frac{1}{5}$)	① AXT632-17-10 (M3 x 62)	3	Not necessary when mounting the sub-plate.	
		② AXT632-17-19 (M3 x 26)	2		
	Valve + Release valve spacer (VVQ4000-24A- $\frac{1}{5}$ D)	① AXT632-17-10 (M3 x 62)	3	For manifold	
		② AXT632-17-19 (M3 x 26)	2		
	Valve + SUP stop valve spacer (VVQ4000-37A- $\frac{1}{5}$)	① AXT632-17-10 (M3 x 62)	3	Not necessary when mounting the sub-plate.	
		② AXT632-17-19 (M3 x 26)	2		
Valve + Double check spacer with residual pressure exhaust (VVQ4000-25A- $\frac{1}{5}$)	① AXT632-17-11 (M3 x 87)	3	Not necessary when mounting the sub-plate.		
	② AXT632-41-1 (M3 x 54)	2			
Valve + Interface regulator (ARBQ4000-00 $\frac{1}{5}$ - $\frac{1}{5}$)	① AXT632-17-11 (M3 x 87)	3	Not necessary when mounting the sub-plate.		
	② AXT632-17-8 (M3 x 52)	2			
Blanking plate + SUP stop valve (Top) (Bottom)	① AXT632-41-4 (M3 x 42)	3	For manifold		
	② AXT632-17-19 (M3 x 26)	2			
2	Valve + Individual SUP + Individual EXH (Top) (Bottom) (Top) (Bottom)	① AXT632-17-11 (M3 x 87)	3	For manifold	
		② AXT632-17-8 (M3 x 52)	2		
	Valve + Restrictor + Individual SUP or Individual EXH (Top) (Bottom) (Top) (Bottom)	① AXT632-17-11 (M3 x 87)	3	For manifold The individual EXH cannot be mounted on the top.	
		② AXT632-17-8 (M3 x 52)	2		
	Valve + SUP stop valve + Individual SUP, Individual EXH or Restrictor (Top) (Bottom)	① AXT632-17-11 (M3 x 87)	3	For manifold	
		② AXT632-17-8 (M3 x 52)	2		
	Valve + Double check spacer with residual pressure exhaust + Individual SUP or Individual EXH (Top) (Bottom)	① AXT632-17-14 (M3 x 112)	3	For manifold	
		② AXT632-41-2 (M3 x 78)	2		
	Valve + Interface regulator + Individual SUP, Individual EXH or Restrictor (Top) (Bottom)	① AXT632-17-14 (M3 x 112)	3	For manifold The individual EXH and restrictor can be mounted on the top.	
		② AXT632-41-2 (M3 x 78)	2		
Valve + Restrictor + Double check spacer with residual pressure exhaust (Top) (Bottom)	① AXT632-17-14 (M3 x 112)	3	For manifold		
	② AXT632-41-2 (M3 x 78)	2			
Valve + Double check spacer with residual pressure exhaust + Interface regulator (Bottom) (Top)	① AXT632-17-16 (M3 x 137)	3	For manifold		
	② AXT632-41-3 (M3 x 103)	2			
Blanking plate + SUP stop valve + Individual SUP (Top) (Bottom)	① AXT632-17-17 (M3 x 66)	3	For manifold		
	② AXT632-17-8 (M3 x 52)	2			
3	Valve + SUP stop valve (Top) + Individual SUP (Middle, Bottom) + Individual EXH (Middle, Bottom)	① AXT632-17-14 (M3 x 112)	3	For manifold	
		② AXT632-17-13 (M3 x 77)	2		
	Valve + Double check spacer with residual pressure exhaust (Top) + Individual SUP (Middle, Bottom) + Individual EXH (Middle, Bottom)	① AXT632-17-16 (M3 x 137)	3	For manifold	
		② AXT632-41-3 (M3 x 103)	2		
	Valve + Spacer (Top): Interface regulator Spacer (Middle): "Individual SUP or Individual EXH"/Restrictor Spacer (Bottom): "Restrictor"/Individual SUP or Individual EXH	① AXT632-17-16 (M3 x 137)	3	For manifold The individual EXH and restrictor can be mounted on the top.	
		② AXT632-41-3 (M3 x 103)	2		
	Valve + Double check spacer with residual pressure exhaust (Top) + SUP stop valve (Middle) + Individual SUP (EXH) (Bottom)	① AXT632-17-16 (M3 x 137)	3	For manifold	
		② AXT632-41-3 (M3 x 103)	2		
Valve + Interface regulator (Top) + Double check spacer with residual pressure exhaust (Middle) + Individual SUP (EXH) (Bottom)	① AXT632-17-20 (M3 x 162)	3	For manifold available as special order		
	② AXT632-41-5 (M3 x 128)	2			

Note) When the SUP stop valve and individual SUP are mounted, the stop valve is mounted on the top of the individual SUP.

F VQC4000

Kit (D-sub connector kit) IP40 compliant

- Using our D-sub connector for electrical connections greatly reduces labor, while it also minimizes wiring and saves space.
- We use a D-sub connector (25P) that conforms to MIL standards and is therefore widely compatible with many standard commercial models.
- Top or side entry for the connector can be changed freely, allowing for changes even after mounting, to meet any changing needs for space.

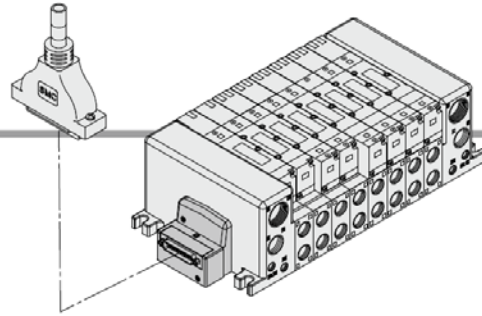

Electrical Wiring Specifications

D-sub connector

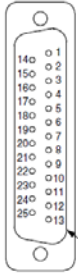

As the standard electrical wiring specification used is for 12 stations or less, double wiring (connected to SOL. A and SOL. B) is used for the internal wiring of each station regardless of valve and option types. Mixed single and double wiring are available as options. Refer to special wiring specifications (options) below.

Lead wire colors for D-sub connector assemblies (AXT100-DS25-015/030/050)

Standard wiring	Terminal no.	Lead wire color	Dot marking
Station 1	SOL.A 1	Black	None
	SOL.B 14	Yellow	Black
Station 2	SOL.A 2	Brown	None
	SOL.B 15	Pink	Black
Station 3	SOL.A 3	Red	None
	SOL.B 16	Blue	White
Station 4	SOL.A 4	Orange	None
	SOL.B 17	Purple	None
Station 5	SOL.A 5	Yellow	None
	SOL.B 18	Gray	None
Station 6	SOL.A 6	Pink	None
	SOL.B 19	Orange	Black
Station 7	SOL.A 7	Blue	None
	SOL.B 20	Red	White
Station 8	SOL.A 8	Purple	White
	SOL.B 21	Brown	White
Station 9	SOL.A 9	Gray	Black
	SOL.B 22	Pink	Red
Station 10	SOL.A 10	White	Black
	SOL.B 23	Gray	Red
Station 11	SOL.A 11	White	Red
	SOL.B 24	Black	White
Station 12	SOL.A 12	Yellow	Red
	SOL.B 25	White	None
COM.	13	Orange	Red

Special Wiring Specifications (Options)

(For 25P)

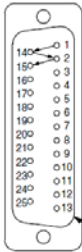

Mixed single and double wiring are available as options. The maximum number of manifold stations is determined by the number of solenoids. Count one point for a single solenoid type and two points for a double solenoid type. The total number of solenoids (points) must not exceed 24.

Cable Assembly

AXT100-DS25-015
030
050

(D-sub connector cable assemblies can be ordered with manifolds.)
Refer to manifold ordering.

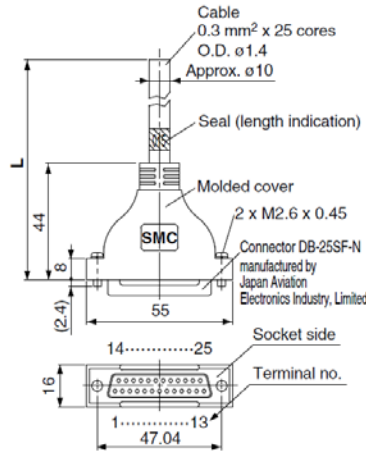

Lead wire colors for D-sub connector cable assembly terminal numbers

Terminal no.	Lead wire color	Dot marking
1	Black	None
2	Brown	None
3	Red	None
4	Orange	None
5	Yellow	None
6	Pink	None
7	Blue	None
8	Purple	White
9	Gray	Black
10	White	Black
11	White	Red
12	Yellow	Red
13	Orange	Red
14	Yellow	Black
15	Pink	Black
16	Blue	White
17	Purple	None
18	Gray	None
19	Orange	Black
20	Red	White
21	Brown	White
22	Pink	Red
23	Gray	Red
24	Black	White
25	White	None

D-sub connector cable assemblies

Cable length [L]	Part no.	Note
1.5 m	AXT100-DS25-015	Cable 0.3 mm² x 25 cores
3 m	AXT100-DS25-030	
5 m	AXT100-DS25-050	

- When using a standard commercial connector, use a type 25P female connector conforming to MIL-C-24308.
- Cannot be used for transfer wiring.
- Lengths other than the above is also available. Please contact SMC for details.

Electrical characteristics

Item	Characteristic
Conductor resistance Ω/km, 20°C	65 or less
Voltage limit V, 1 minute, AC	1000
Insulation resistance MΩ/km, 20°C	5 or more

Note) The minimum bending radius for D-sub connector cables is 20 mm.

Connector Manufacturers Example

- Fujitsu, Limited
- Japan Aviation Electronics Industry, Limited
- J.S.T. Mfg. Co., Ltd.
- HIROSE ELECTRIC CO., LTD.

P VQC4000 Kit (Flat ribbon cable kit) IP40 compliant

- Using our flat ribbon cable for electrical connections greatly reduces labour, while it also minimizes wiring and saves space.
- We use flat ribbon cables whose connectors (26P and 20P) conform to MIL standards, and are therefore widely compatible with many standard commercial models.
- Top or side entry for the connector can be changed freely, allowing for changes even after mounting, to meet any changing needs for space.

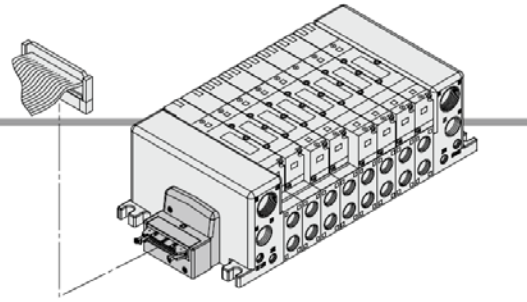

Electrical Wiring Specifications

Flat ribbon cable connector

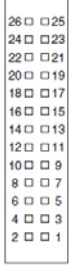

Double wiring (connected to SOL. A and SOL. B) is used for the internal wiring of each station regardless of valve and option types. Mixed single and double wiring are available as options. Refer to special wiring specifications (options) below.

Connector terminal number

Triangle mark indicator position

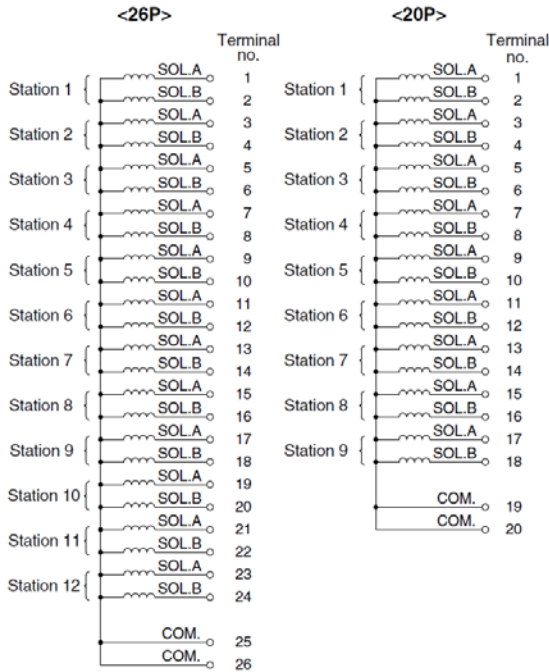

Cable Assembly

AXT100-FC²⁰₂ -¹₂ -³₃

(Type 26P flat ribbon cable connector assemblies can be ordered with manifolds. Refer to manifold ordering.)

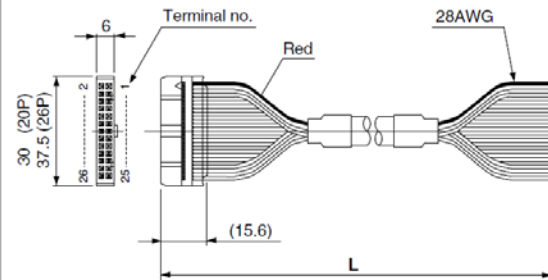

Flat ribbon cable connector assemblies

Cable length [L]	Part no.	
	26P	20P
1.5 m	AXT100-FC26-1	AXT100-FC20-1
3 m	AXT100-FC26-2	AXT100-FC20-2
5 m	AXT100-FC26-3	AXT100-FC20-3

- * When using a standard commercial connector, use a type 26P connector conforming to MIL-C-83503 or a type 20P with strain relief.
- * Cannot be used for transfer wiring.
- * Lengths other than the above is also available. Please contact SMC for details.

Connector Manufacturers Example

- HIROSE ELECTRIC CO., LTD.
- 3M Japan Limited
- Fujitsu, Limited
- Japan Aviation Electronics Industry, Limited
- J.S.T. Mfg. Co., Ltd.
- Oki Electric Cable Co., Ltd.

Special Wiring Specifications (Option)

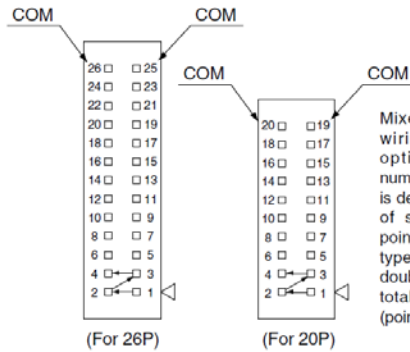

Mixed single and double wiring are available as options. The maximum number of manifold stations is determined by the number of solenoids. Count one point for a single solenoid type and two points for a double solenoid type. The total number of solenoids (points) must not exceed 24.

T VQC4000

Kit (Terminal block box kit) IP67 compliant

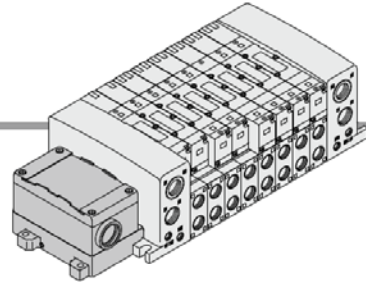

- This kit has a small terminal block inside a junction box. The provision of a G3/4 electrical entry allows connection of conduit fittings.

Terminal Block Connection

Step 1. How to remove terminal block cover

Loosen the 4 mounting screws (M4) and remove the terminal block cover.

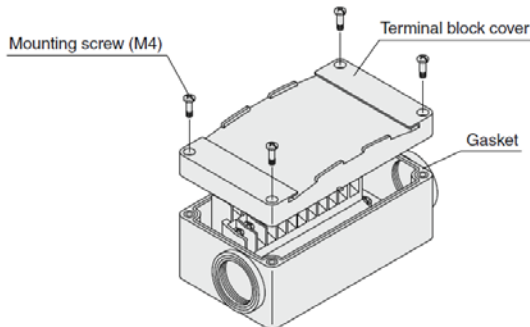

Step 3. How to replace the terminal block cover

Securely tighten the screws to the torque shown in the table below, after confirming that the gasket is installed correctly.

Proper tightening torque [N·m]
0.7 to 1.2

- Applicable crimped terminal: 1.25-3S, 1.25Y-3, 1.25Y-3N, 1.25Y-3.5
- Name plate: VVQ5000-N-T
- Drip proof plug assembly (for G3/4): AXT100-B06A

Step 2. The diagram below shows the terminal block wiring.

All stations are provided with double wiring regardless of the valves which are mounted. Connect each wire to the power supply side, according to the markings provided inside the terminal block.

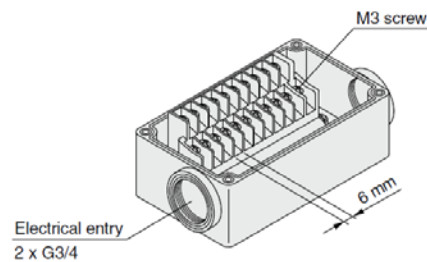

Electrical Wiring Specifications (Conforms to IP67)

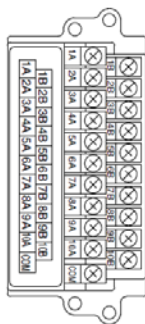

The internal wiring is double (connected to SOL. A and SOL. B) for all stations regardless of the type of valve or options. Mixed single and double wiring are available as options.

Standard wiring

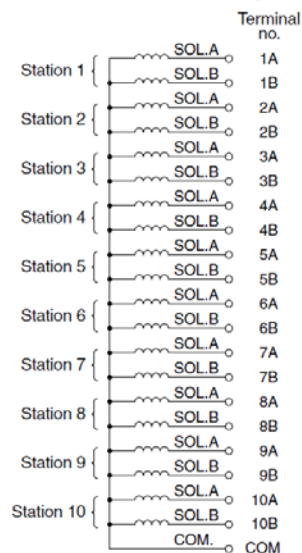

Special Wiring Specifications (Option)

Mixed single and double wiring are available as options. The maximum number of manifold stations is determined by the number of solenoids. Count one point for a single solenoid type and two points for a double solenoid type. The total number of solenoids (points) must not exceed 20.

1. How to Order

Indicate option symbol "-K" in the manifold part number and be sure to specify station positions for single or double wiring on the manifold specification sheet.

2. Wiring specifications

Connector terminal numbers are connected from solenoid station 1 on the A side in the order indicated by the arrows without skipping any terminal numbers.



L VQC4000

Kit (Lead wire kit) IP67 compliant

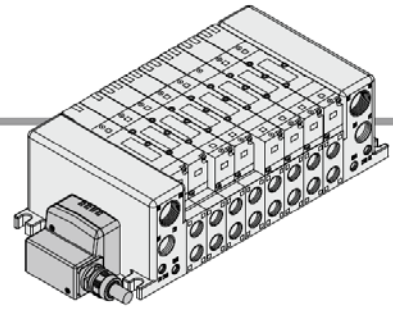

- Direct electrical entry type
- IP67 enclosure is available with use of cables with sheath and waterproof connectors.

Electrical Wiring Specifications

Lead wire specifications

Lead wire
0.3 mm² x 25 cores

Sheath
Color: Urban white

As the standard electrical wiring specification used is for 12 stations or less, double wiring (connected to SOL. A and SOL. B) is used for the internal wiring of each station regardless of valve and option types. Mixed single and double wiring are available as options. Refer to special wiring specifications (options) below.

Lead wire length

VV5QC41-08 C12 LD **0**

Lead wire length

0	0.6 m
1	1.5 m
2	3.0 m

Electrical characteristics

Item	Characteristic
Conductor resistance Ω/km , 20°C	65 or less
Withstand pressure V, 1 minute, AC	1000
Insulation resistance $M\Omega/\text{km}$, 20°C	5 or more

Note) Cannot be used for transfer wiring.
The minimum bending radius for cables is 20 mm.

Terminal no.	Lead wire color	Dot marking
Station 1 { SOL.A 1	Black	None
Station 1 { SOL.B 14	Yellow	Black
Station 2 { SOL.A 2	Brown	None
Station 2 { SOL.B 15	Pink	Black
Station 3 { SOL.A 3	Red	None
Station 3 { SOL.B 16	Blue	White
Station 4 { SOL.A 4	Orange	None
Station 4 { SOL.B 17	Purple	None
Station 5 { SOL.A 5	Yellow	None
Station 5 { SOL.B 18	Gray	None
Station 6 { SOL.A 6	Pink	None
Station 6 { SOL.B 19	Orange	Black
Station 7 { SOL.A 7	Blue	None
Station 7 { SOL.B 20	Red	White
Station 8 { SOL.A 8	Purple	White
Station 8 { SOL.B 21	Brown	White
Station 9 { SOL.A 9	Gray	Black
Station 9 { SOL.B 22	Pink	Red
Station 10 { SOL.A 10	White	Black
Station 10 { SOL.B 23	Gray	Red
Station 11 { SOL.A 11	White	Red
Station 11 { SOL.B 24	Black	White
Station 12 { SOL.A 12	Yellow	Red
Station 12 { SOL.B 25	White	None
COM. 13	Orange	Red

Special Wiring Specifications (Option)

Mixed single and double wiring are available as options. The maximum number of manifold stations is determined by the number of solenoids. Count one point for a single solenoid type and two points for a double solenoid type. The total number of solenoids (points) must not exceed 24.



VQC4000

Kit (Circular connector kit) IP67 compliant

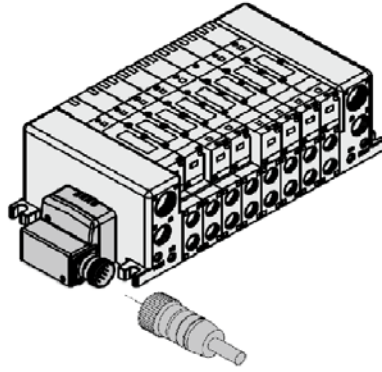

- Use of circular connectors helps streamline wiring procedure to save labor.
- IP67 enclosure is available with use of waterproof multiple connectors.

Electrical Wiring Specifications

Multiple connector



Double wiring (connected to SOL.A and SOL.B) is used for the internal wiring of each station regardless of valve and option types. Mixed single and double wiring are available as options. Refer to special wiring specifications (options) below.

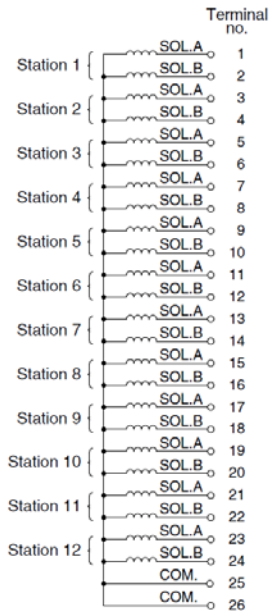

Special Wiring Specifications (Option)

Mixed single and double wiring are available as an option. The maximum number of manifold stations is determined by the number of solenoids. Count one point for a single solenoid type and two points for a double solenoid type. The total number of solenoids (points) must not exceed 24.

Cable Assembly

015
AXT100-MC26-030
050

(Type 26P circular connector cable assemblies can be ordered with manifolds. Refer to manifolds ordering.)

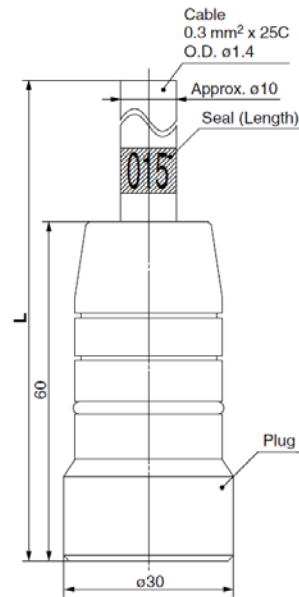

Lead wire colors for circular connector cable assembly terminal numbers

Terminal no.	Lead wire color	Dot marking
1	Black	None
2	Brown	None
3	Red	None
4	Orange	None
5	Yellow	None
6	Pink	None
7	Blue	None
8	Purple	White
9	Gray	Black
10	White	Black
11	White	Red
12	Yellow	Red
13	Orange	Red
14	Yellow	Black
15	Pink	Black
16	Blue	White
17	Purple	None
18	Gray	None
19	Orange	Black
20	Red	White
21	Brown	White
22	Pink	Red
23	Gray	Red
24	Black	White
25	White	None
26	White	None

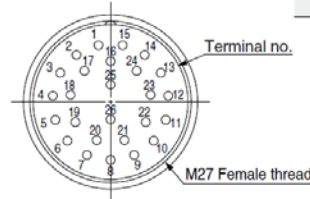

Electric characteristics

Item	Property
Conductor resistance Ω/km, 20°C	65 or less
Voltage limit V, 1 minute, AC	1000
Insulation resistance MΩ/km, 20°C	5 or more

Note) The minimum bending radius of the multiple connector cable is 20 mm.

Circular connector cable assemblies

Cable length [L]	Assembly part no.
	26P
1.5 m	AXT100-MC26-015
3 m	AXT100-MC26-030
5 m	AXT100-MC26-050

- * Cannot be used for transfer wiring.
- * Lengths other than the above is also available. Please contact SMC for details.

Trouble	When the valve is failing, use this flow chart to clarify the cause of the failure and take countermeasures appropriate for the cause.	Possible cause	Countermeasures
<p>Operating failure The air supply does not switch the valve.</p>	<pre> graph TD Q1{Can manual override move the valve?} -- NO --> C1 Q1 -- YES --> Q2{Does the indicator light keep turning on during energization?} Q2 -- NO --> C3 Q2 -- YES --> C2 Q3{Does the indicator light keep turning on during energization?} -- YES --> C4 </pre>	<p>1) Sliding failure or stick of main valve. A foreign material included in supplied air is caught by main valve and makes the main valve unable to slide smoothly or sticky.</p>	<ul style="list-style-type: none"> • Replace with new valve. • Clean the supplied air.
		<p>2) Pressure drop. The pressure of supplied air lowers the valve which can operate the valve (min. operating pressure).</p>	<p>Raise the pressure of supplied air up to operating pressure of the valve.</p>
		<p>1) Failure of electrical system</p> <ul style="list-style-type: none"> • Incorrect wiring • Blow of fuse and breakage of lead wire. • Poor contact at contactor wire or connection part • Failure of sequencer • Lack of supply voltage 	<p>Check these items and replace part and re-wire positively.</p>
		<p>1) Voltage drop Even if the indicator light keeps turning on, the valve can't be operated due to the voltage drop.</p>	<ul style="list-style-type: none"> • Check the voltage and if it is not enough to operate the valve, take appropriate measures.
		<p>2) Leakage current When the power turns off, the valve can't be switched due to residual voltage.</p>	<ul style="list-style-type: none"> • Confirm the residual voltage is follows. • DC is 3% or less of rated voltage.
		<p>3) Failure of pilot valve</p> <ul style="list-style-type: none"> • Foreign matter caught in core of pilot valve. • Disconnection coil wire of pilot valve • Swelled out poppet of pilot valve • Burnt coil of pilot valve (Higher voltage or wrong coil used, Coil splashed by water) 	<ul style="list-style-type: none"> • Replace part or re-wire positively. • Check voltage. Replace valve. (Pilot valve) • Replace valve (pilot valve). Protect the valve so that water does not splash the coil.
<p>Response failure The operation of the valve is delay.</p>		<p>1) Current leakage When the power turns off, the valve can be switched late due to residual voltage.</p> <p>2) Clogging of filter element of manifold.</p> <p>3) Sliding failure or stick of main valve. A foreign material included in supplied air is caught by main valve and makes the main valve unable to slide smoothly or sticky.</p>	<ul style="list-style-type: none"> • Confirm the residual voltage is follows. • DC is 3% or less of rated voltage. • Clean the element or replace with new element. • Replace with new valve. • Clean the supplied air.

Trouble	When the valve is failing, use this flow chart to clarify the cause of the failure and take countermeasures appropriate for the cause.	Possible cause	Countermeasures
Air leakage	<div style="border: 1px solid black; border-radius: 10px; padding: 5px; width: fit-content; margin: 0 auto;">Confirm there is air leakage.</div> <p>1. Between valve and base</p>	1-1) Looseness of clamp screw or mounting bolt.	Give more torque to clamp screw. •VQC4000 : 0.8~1.2N•m If the damage is seen on the gasket, replace with new gasket.
		1-2) Caught gasket	Replace with new gasket.
		1-3) Intrusion of foreign matter	To remove foreign matter by air blow of piping and when a gasket damaged, replace with new gasket.
	2. Air leaks through One-touch fitting	2-1) Tube is not inserted enough deeply. 2-2) Tube has a flaw. 2-3) Tube is cut diagonally.	Check these items and replace part and re-wire positively.
		2-4) Packing of one touch fitting is damaged.	Replace with one-touch fitting.
	3. Air leaks through exhaust port (R port) Note) The valve with metal seal allows air leakage from main valve approx. 200Ncc for each port (at 0.5MPa). The air leakage within the range should not be considered abnormal.	3-1) Looseness of clamp screw or mounting bolt.	Give more torque to clamp screw. Tightening torque •VQC4000 : 0.8~1.2N•m If the damage is seen on the gasket, replace with new gasket.
		3-2) A foreign material included into supplied air is caught by the main valve and increases internal air leakage.	<ul style="list-style-type: none"> • Replace with new valve. • Clean the supplied air.
4. Air leaks through manifold.	Insufficient bolt tightening	After stopping air and re-tighten the bolts. •VQC4000 : 4~6N•m	

Revision

SMC Corporation

4-14-1, Sotokanda, Chiyoda-ku, Tokyo 101-0021 JAPAN

Tel: + 81 3 5207 8249 Fax: +81 3 5298 5362

URL <http://www.smcworld.com>

Note: Specifications are subject to change without prior notice and any obligation on the part of the manufacturer.
© 2019 SMC Corporation All Rights Reserved

