



Operation Manual

PRODUCT NAME

Digital Pressure Switch

MODEL / Series / Product Number

ZSE20B(F)
ISE20B

SMC Corporation

Table of Contents

Safety Instructions	2
Model Indication and How to Order	8
Summary of Product parts	10
Definition and terminology	11
Mounting and Installation	15
Installation	15
Piping	17
Wiring	19
Outline of Settings [Measurement mode]	22
Pressure Setting	23
3 Step Setting Mode	24
Simple Setting Mode	26
Function Selection Mode	28
Function selection mode	28
Default setting	28
F 0 Units selection function	30
F 1 Setting of OUT1	31
F 2 Setting of OUT2	34
F 3 Digital filter setting	36
F 4 Auto-preset function	37
F 5 FUNC terminal setting	39
F 6 Fine adjustment of display value	41
F10 Sub display setting	42
F11 Display resolution setting	48
F80 Power saving mode	49
F81 Security code	50
F82 Input of line name	52
F90 Setting of all functions	53
F96 Input signal check	55
F97 Selection of copy function	56
F98 Output check	58
F99 Reset to default settings	60
Other Settings	61
Maintenance	65
Forgotten the security code	65
Troubleshooting	66
Specification	75
Specifications	75
Dimensions	77



Safety Instructions

These safety instructions are intended to prevent hazardous situations and/or equipment damage. These instructions indicate the level of potential hazard with the labels of "Caution", "Warning" or "Danger". They are all important notes for safety and must be followed in addition to International Standards (ISO/IEC)*1), and other safety regulations.

*1) ISO 4414: Pneumatic fluid power -- General rules relating to systems.

ISO 4413: Hydraulic fluid power -- General rules relating to systems.

IEC 60204-1: Safety of machinery -- Electrical equipment of machines .(Part 1: General requirements)

ISO 10218: Manipulating industrial robots -Safety.

etc.



Caution

Caution indicates a hazard with a low level of risk which, if not avoided, could result in minor or moderate injury.



Warning

Warning indicates a hazard with a medium level of risk which, if not avoided, could result in death or serious injury.



Danger

Danger indicates a hazard with a high level of risk which, if not avoided, will result in death or serious injury.

Warning

1. The compatibility of the product is the responsibility of the person who designs the equipment or decides its specifications.

Since the product specified here is used under various operating conditions, its compatibility with specific equipment must be decided by the person who designs the equipment or decides its specifications based on necessary analysis and test results.

The expected performance and safety assurance of the equipment will be the responsibility of the person who has determined its compatibility with the product.

This person should also continuously review all specifications of the product referring to its latest catalog information, with a view to giving due consideration to any possibility of equipment failure when configuring the equipment.

2. Only personnel with appropriate training should operate machinery and equipment.

The product specified here may become unsafe if handled incorrectly.

The assembly, operation and maintenance of machines or equipment including our products must be performed by an operator who is appropriately trained and experienced.

3. Do not service or attempt to remove product and machinery/equipment until safety is confirmed.

1. The inspection and maintenance of machinery/equipment should only be performed after measures to prevent falling or runaway of the driven objects have been confirmed.

2. When the product is to be removed, confirm that the safety measures as mentioned above are implemented and the power from any appropriate source is cut, and read and understand the specific product precautions of all relevant products carefully.

3. Before machinery/equipment is restarted, take measures to prevent unexpected operation and malfunction.

4. Contact SMC beforehand and take special consideration of safety measures if the product is to be used in any of the following conditions.

1. Conditions and environments outside of the given specifications, or use outdoors or in a place exposed to direct sunlight.

2. Installation on equipment in conjunction with atomic energy, railways, air navigation, space, shipping, vehicles, military, medical treatment, combustion and recreation, or equipment in contact with food and beverages, emergency stop circuits, clutch and brake circuits in press applications, safety equipment or other applications unsuitable for the standard specifications described in the product catalog.

3. An application which could have negative effects on people, property, or animals requiring special safety analysis.

4. Use in an interlock circuit, which requires the provision of double interlock for possible failure by using a mechanical protective function, and periodical checks to confirm proper operation.



Safety Instructions

Caution

1. The product is provided for use in manufacturing industries.

The product herein described is basically provided for peaceful use in manufacturing industries. If considering using the product in other industries, consult SMC beforehand and exchange specifications or a contract if necessary. If anything is unclear, contact your nearest sales branch.

Limited warranty and Disclaimer/Compliance Requirements

The product used is subject to the following "Limited warranty and Disclaimer" and "Compliance Requirements".

Read and accept them before using the product.

Limited warranty and Disclaimer

1. The warranty period of the product is 1 year in service or 1.5 years after the product is delivered, whichever is first.*2)

Also, the product may have specified durability, running distance or replacement parts. Please consult your nearest sales branch.

2. For any failure or damage reported within the warranty period which is clearly our responsibility, a replacement product or necessary parts will be provided.

This limited warranty applies only to our product independently, and not to any other damage incurred due to the failure of the product.

3. Prior to using SMC products, please read and understand the warranty terms and disclaimers noted in the specified catalog for the particular products.

***2) Vacuum pads are excluded from this 1 year warranty.**

A vacuum pad is a consumable part, so it is warranted for a year after it is delivered.

Also, even within the warranty period, the wear of a product due to the use of the vacuum pad or failure due to the deterioration of rubber material are not covered by the limited warranty.

Compliance Requirements

1. The use of SMC products with production equipment for the manufacture of weapons of mass destruction (WMD) or any other weapon is strictly prohibited.

2. The exports of SMC products or technology from one country to another are governed by the relevant security laws and regulation of the countries involved in the transaction. Prior to the shipment of a SMC product to another country, assure that all local rules governing that export are known and followed.

Caution

SMC products are not intended for use as instruments for legal metrology.

Products that SMC manufactures or sells are not measurement instruments that are qualified by pattern approval tests relating to the measurement laws of each country.

Therefore, SMC products cannot be used for business or certification ordained by the measurement laws of each country.

Operator

- ◆ This operation manual is intended for those who have knowledge of machinery using pneumatic equipment, and have sufficient knowledge of assembly, operation and maintenance of such equipment. Only those persons are allowed to perform assembly, operation and maintenance.
- ◆ Read and understand this operation manual carefully before assembling, operating or providing maintenance to the product.

■ Safety Instructions

Warning

- Do not disassemble, modify (including changing the printed circuit board) or repair.
An injury or failure can result.
- Do not operate the product outside of the specifications.
Do not use for flammable or harmful fluids.
Fire, malfunction, or damage to the product can result.
Verify the specifications before use.
- Do not operate in an atmosphere containing flammable or explosive gases.
Fire or an explosion can result.
This product is not designed to be explosion proof.
- Do not use the product in a place where static electricity is a problem.
Otherwise it can cause failure or malfunction of the system.
- If using the product in an interlocking circuit:
 - Provide a double interlocking system, for example a mechanical system
 - Check the product regularly for proper operationOtherwise malfunction can result, causing an accident.
- The following instructions must be followed during maintenance:
 - Turn off the power supply
 - Stop the air supply, exhaust the residual pressure and verify that the air is released before performing maintenanceOtherwise an injury can result.

Caution

- Do not touch the terminals and connectors while the power is on.
Otherwise electric shock, malfunction or damage to the product can result.
- After maintenance is complete, perform appropriate functional inspections and leak tests.
Stop operation if the equipment does not function properly or there is a leakage of fluid.
When leakage occurs from parts other than the piping, the product might be faulty.
Disconnect the power supply and stop the fluid supply.
Do not apply fluid under leaking conditions.
Safety cannot be assured in the case of unexpected malfunction.

■ NOTE

- Follow the instructions given below when designing, selecting and handling the product.
 - The instructions on design and selection (installation, wiring, environment, adjustment, operation, maintenance, etc.) described below must also be followed.
 - *Product specifications
 - The direct current power supply to be used should be UL approved as follows:
Circuit (of Class 2) which is of maximum 30 Vrms (42.4 V peak), with UL1310 Class 2 power supply unit or UL1585 Class 2 transformer.
 - The product is a UL approved product only if it has a  mark on the body.
 - Use the specified voltage.
Otherwise failure or malfunction can result.
 - Do not exceed the specified maximum allowable load.
Otherwise it can cause damage or shorten the lifetime of the Pressure switch.
 - Design the product to prevent reverse current when the circuit is opened or the product is forced to operate for operational check.
Reverse current can cause malfunction or damage to the product.
 - Input data to the Pressure switch is not deleted, even if the power supply is cut off.
(Writing time: 10,000 times, Data duration: 20 years after power off)
 - Use the clean air.
This can cause operating failure.
If compressed air containing condensate is used, install an air dryer or drain catch before the filter and perform drainage regularly.
If drainage is not performed regularly and condensate enters the secondary side, it can cause operating failure of pneumatic equipment.
If regular drainage is difficult, the use of a filter with an auto drain is recommended.
 - Applicable fluid is air, inert gases and incombustible gases.
Do not use a fluid containing chemicals, synthetic oils including organic solvent, salt and corrosive gases.
Otherwise, damage to the product and malfunction can result.
Check the details of the specifications before using.
 - Use the specified measurement flow rate and operating pressure.
Otherwise it can cause damage to the pressure switch or inability to measure correctly.
 - Reserve a space for maintenance.
Allow sufficient space for maintenance when designing the system.

●Product handling

*Installation

- Tighten to the specified tightening torque.
If the tightening torque is exceeded the mounting screws and brackets may be broken.
If the tightening torque is insufficient, the product can be displaced and loosen the mounting screws.
- Do not apply excessive stress to the product when it is mounted with a panel mount.
Otherwise damage to the product and disconnection from the panel mount can result.
- Be sure to ground terminal FG when using a commercially available switch-mode power supply.
- Do not drop, hit or apply shock to the Pressure switch.
Otherwise damage to the internal parts can result, causing malfunction.
- Do not pull the lead wire forcefully, not lift the product by pulling the lead wire. (Tensile force 35 N or less)
Hold the body when handling to avoid the damage of the Pressure switch which lead to cause the failure and malfunction.
- For piping of the Pressure switch, hold the piping with a spanner on the metal part of the piping (Piping attachment).
Holding other part with spanner leads to damage the Pressure switch.
- Eliminate any dust left in the piping by air blow before connecting the piping to the product.
Otherwise it can cause damage or malfunction.
- Do not insert metal wires or other foreign matter into the pressure measurement port.
It can damage the pressure sensor causing failure or malfunction.
- Never mount a Pressure switch in a location that will be used as a foothold.
The product may be damaged if excessive force is applied by stepping or climbing onto it.
- If the entering of foreign material to the fluid is possible, install and pipe the filter or the mist separator to the inlet to avoid failure and malfunction.

*Wiring

- Do not pull the lead wires.
In particular, never lift a Pressure switch equipped with fitting and piping by holding the lead wires.
Otherwise damage to the internal parts can result, causing malfunction or to be off the connector.
- Avoid repeatedly bending or stretching the lead wire, or placing heavy load on them.
Repetitive bending stress or tensile stress can cause the sheath of the wire to peel off, or breakage of the wire.
If the lead wire can move, fix it near the body of the product.
The recommended bend radius of the lead wire is 6 times the outside diameter of the sheath, or 33 times the outside diameter of the insulation material, whichever is larger.
Replace the damaged lead wire with a new one.
- Wire correctly.
Incorrect wiring can break the Pressure switch.
- Do not perform wiring while the power is on.
Otherwise damage to the internal parts can result, causing malfunction.
- Do not route wires and cables together with power or high voltage cables.
Otherwise the product can malfunction due to interference of noise and surge voltage from power and high voltage cables to the signal line. Route the wires (piping) of the product separately from power or high voltage cables.
- Confirm proper insulation of wiring.
Poor insulation (interference from another circuit, poor insulation between terminals, etc.) can lead to excess voltage or current being applied to the product, causing damage.
- Design the system to prevent reverse current when the product is forced to operate for operational check.
Depending on the circuit used, insulation may not be maintained when operation is forced, allowing reverse current to flow, which can cause malfunction and damage the product.
- Keep wiring as short as possible to prevent interference from electromagnetic noise and surge voltage.
Do not use a cable longer than 30 m.
Wire the DC(-) line(blue) as close as possible to the power supply.
- When analog output is used, install a noise filter (line noise filter, ferrite element, etc.) between the switch-mode power supply and this product.

*Environment

- Do not use the product in area that is exposed to corrosive gases, chemicals, sea water, water or steam.
Otherwise failure or malfunction can result.

- Do not use in a place where the product could be splashed by oil or chemicals.
If the product is to be used in an environment containing oils or chemicals such as coolant or cleaning solvent, even for a short time, it may be adversely affected (damage, malfunction, or hardening of the lead wires).
- Do not use in an area where surges are generated.
If there is equipment which generates a large amount of surge (solenoid type lifter, high frequency induction furnace, motor, etc.) close to the Pressure switch, this may cause deterioration or breakage of the internal circuit of the Pressure switch. Avoid sources of surge generation and crossed lines.
- Do not use a load which generates surge voltage.
When a surge-generating load such as a relay or solenoid is driven directly, use a Pressure switch with a built-in surge absorbing element.
- The product is CE marked, but not immune to lightning strikes. Take measures against lightning strikes in the system.
- Mount the product in a place that is not exposed to vibration or impact.
Otherwise failure or malfunction can result.
- Prevent foreign matter such as remnant of wires from entering the Pressure switch.
Take proper measures for the remnant not to enter the Pressure switch in order to prevent failure or malfunction.
- Do not use the product in an environment that is exposed to temperature cycle.
Heat cycles other than ordinary changes in temperature can adversely affect the inside of the product.
- Do not expose the product to direct sunlight.
If using in a location directly exposed to sunlight, shade the product from the sunlight.
Otherwise failure or malfunction can result.
- Keep within the specified fluid and ambient temperatures range.
The fluid and ambient temperatures should be -5 to 50 °C. Operation under low temperature (5 °C or less) leads to cause damage or operation failure due to frozen moist in the fluid or air.
Protection against freezing is necessary. Air dryer is recommended for elimination of drain and water.
Avoid sudden temperature change even within specified temperature.
- Do not operate close to a heat source, or in a location exposed to radiant heat.
Otherwise malfunction can result.

*Adjustment and Operation

- Turn the power on after connecting a load.
Otherwise it can cause excess current causing instantaneous breakage of the Pressure switch.
- Do not short-circuit the load.
Although error is displayed when the Pressure switch load is short circuit, generated excess current lead to cause the damage of the Pressure switch.
- Do not press the setting buttons with a sharp pointed object.
It may damage the setting buttons.
- If using the product to detect very small pressure rates, warm up the product for 10 to 15 minutes first.
There will be a drift on the display of approximate $\pm 1\%$ immediately after the power supply is turned on, within 10 minutes.
- Perform settings suitable for the operating conditions.
Incorrect setting can cause operation failure.
For details of each setting, refer to page 22 to 64 of this manual.
- Do not touch the LCD during operation.
The display can vary due to static electricity.

*Maintenance

- Turn off the power supply, stop the supplied air, exhaust the residual pressure and verify the release of air before performing maintenance.
There is a risk of unexpected malfunction.
- Perform regular maintenance and inspections.
There is a risk of unexpected malfunction.
- Perform drainage regularly.
If condensate enters the secondary side, it can cause operating failure of pneumatic equipment.
- Do not use solvents such as benzene, thinner etc. to clean the Pressure switch.
They could damage the surface of the body and erase the markings on the body.
Use a soft cloth to remove stains. For heavy stains, use a cloth soaked with diluted neutral detergent and fully squeezed, then wipe up the stains again with a dry cloth.

Model Indication and How to Order

ISE20B - **X** - **M** - **M5** -

Pressure range

	Symbol	Content
Positive pressure	ISE20B	-0.100 to 1.000 MPa
Vacuum pressure	ZSE20B	0.0 to -101.0 kPa
Compound pressure	ZSE20BF	-100.0 to 100.0 kPa

Output specification

Symbol	Content
X	NPN open collector 2 outputs (with copy function)
Y	PNP open collector 2 outputs (with copy function)
R	NPN open collector 2 outputs + Analog voltage *1
T	PNP open collector 2 outputs + Analog voltage *1
S	NPN open collector 2 outputs + Analog current *1
V	PNP open collector 2 outputs + Analog current *1

*1: Possible to switch to auto shift and copy.

Unit specification

Symbol	Content
Nil	With units selection function
M	Fixed SI unit *3
P	With units selection function (psi initial value) *2

*2: The new Measurement Law prohibits the use of pressure switch with the units selection function in Japan. A unit label is attached.

*3: Fixed unit kPa, MPa

Piping specification

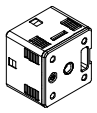
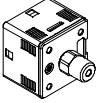
Symbol	Content	
M5	M5 female thread	
01	R1/8	
N01	NPT1/8	

Option 3

Symbol	Content
Nil	With operation manual
Y	None
K	With operation manual + calibration certificate
T	With calibration certificate

Option 2

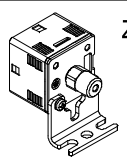
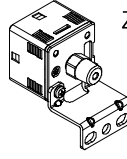
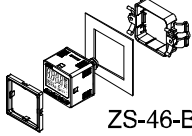
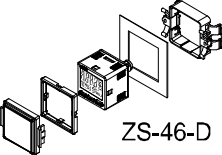
Symbol	Content	
Nil	No option	
A1	Bracket A (Vertical)	 ZS-46-A1
A2	Bracket B (Horizontal)	 ZS-46-A2
B	Panel mount adapter	 ZS-46-B
D	Panel mount adapter + Front protective cover	 ZS-46-D

Option 1

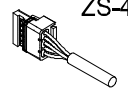
Symbol	Content	
Nil	Without lead wire	
W	Lead wire with connector (lead wire length 2 m, waterproof)	 ZS-46-5F

○Accessories/Part numbers

If an option is required independently, order with the following part numbers.

Items	Part No.	Remarks
Bracket A	ZS-46-A1	Self tapping screws: Nominal size 3 x 8L (2 pcs)
Bracket B	ZS-46-A2	Self tapping screws: Nominal size 3 x 8L (2 pcs)
Panel mount adapter	ZS-46-B	-
Panel mount adapter + Front protective cover	ZS-46-D	-
Lead wire with connector	ZS-46-5F	5 cores, 2 m, waterproof
Front protective cover	ZS-27-01	-
R1/8 piping adapter	ZS-46-N1	-
NPT1/8 piping adapter	ZS-46-N2	-

Summary of Product parts

Names of individual parts

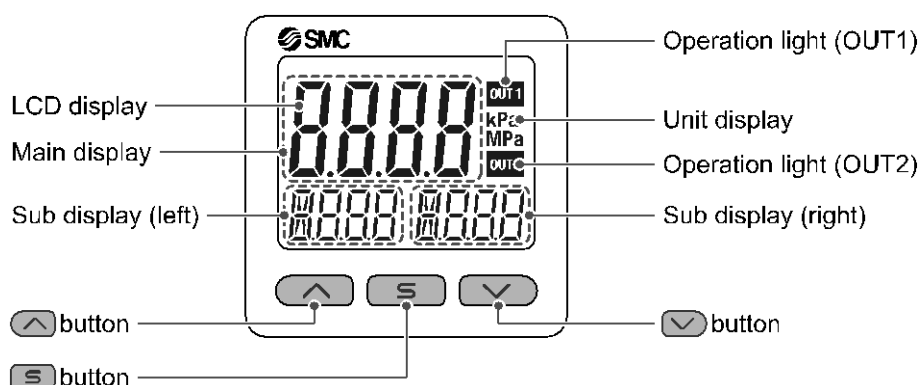

Operation light: Displays the switch operating condition.

LCD display: Displays the current status of pressure, setting mode, selected display units and error code.
 4 types of display can be selected for the main display: Single color of constant red or green; or switching from red to green or green to red corresponding to the output.
 The indication for the sub display is orange.

^ button: Increases mode and ON/OFF set values.

v button: Decreases mode and ON/OFF set values.

S button: Press this button to change mode and to confirm settings.

Unit display: Indicates the units currently selected. (Only for display units of kPa and MPa.)

■ Definition and terminology

	Term	Definition
A	Analog current output	Refer to "Analog output (function)".
	Analog output function	Function to output the voltage or current in proportion to the pressure.
	Analog voltage output	Refer to "Analog output (function)".
	Auto-preset	Performs pressure setting automatically by detecting the increase and decrease in pressure. For example, if this function is used for a suction test, the pressure setting will be completed by performing suction and release of the workpiece.
	Auto-shift	A function to correct the set value of the switch output in accordance with the applied pressure in case the switch operation is unstable due to pulsation of applied pressure. This function is used in applications such as vacuum adsorption. The pressure when a signal is externally input is set as a reference value with which the pressure that turns the switch on or off can be shifted.
B	Bottom value display (mode)	Shows the minimum pressure from when the power was supplied to the current time.
C	Chattering	The problem of the switch output turning ON and OFF repeatedly around the set value at high frequency due to the effect of pulsation.
	Chattering prevention function	A function to delay the response time of switch output in order to prevent chattering.
	Copy function	A function to copy a pressure setting value and function setting (Excludes finely adjusted displayed values and line names.).
D	Delay time	The setting time from when the pressure applied to the pressure switch reaches the set value, to when the ON-OFF output actually begins working. Delay time setting can prevent the output from chattering. The response time indicates when the set value is 90% in relation to the step input.
	digit (Min. setting unit)	Shows how precisely the pressure can be displayed or set by the digital pressure switch. When 1 digit = 1 kPa, the pressure is displayed in increments of 1 kPa, e.g., 1, 2, 3, ..., 99, 100.
	Digital filter	Function to add digital filtering to the fluctuation of pressure value. Smooth the fluctuation of displayed value for sharp start up or fall of the pressure. When the function is valid, digital filtering is reflected to the ON/OFF of the switch output. Output chattering or flicker in the measurement mode display can be reduced by setting the digital filter.
	Display accuracy	Shows The maximum deviation between the displayed pressure value and the true pressure.
	Display color	Indicates the color of the number of digital display. Always green, always red, green (switch OFF) → red (switch ON), red (switch OFF) → green (switch ON) are available.
	Display resolving power	Indicate in how many the rated pressure range can be divided to display. (Example: When the value can be displayed down to 0.001 MPa for the product for 0 to 1 Mpa, the resolution is 1/1000)
	Display value fine adjustment (function)	Displayed pressure value can be adjusted within the range of $\pm 5\%$ R.D. ($\pm 5\%$ of displayed value). It is used if the true pressure value is known, or to eliminate differences between the displayed values of different instruments that are measuring the same pressure.

	Term	Definition
E	Error displayed	The code number displayed, identifying the error detected by the self-diagnosis function of the pressure switch. Refer to "Error indication function" on page 74 for details of the errors.
	Error output	Switches the switch output to ON/OFF when an error is displayed. Refer to "List of output modes" on page 33 for operating conditions. Refer to "Error indication function" on page 74 for details of the errors.
F	F.S. (full span/full scale)	Abbreviation of full span and full scale; difference between the minimum and maximum rated pressure values. means the maximum fluctuation range of the pressure switch rated value. For example, when the rated pressure range is -0.100 to 1.000 [MPa]: F.S. = 1.000 - (-0.100) = 1.100 [MPa] (Reference: 1%F.S. = 1.100 x 0.01 = 0.011 [MPa])
	Fine adjustment mode	Refer to "Display value fine adjustment (function)".
	Fluid contact part (or wetted part)	Part of the pressure switch which contacts detected fluid. Pressure sensor, seal and fitting are included.
	Function selection mode	A mode in which setting of functions is performed. It is a separate menu from the pressure setting. If any function settings need to be changed from the factory default, each setting can be selected with "F*". The setting items are: operation mode, output type, display color, digital filter, use of auto preset, analog/auto shift/copy, display value fine adjustment, sub screen display, display resolution, use of power saving mode and use of security code.
H	Hysteresis	Difference between the points at which the pressure switch is turned ON and OFF.
	Hysteresis mode	Refer to the "List of output modes" on page 33.
I	Insulation resistance	Insulation resistance of the product. The resistance between the electrical circuit and the case.
K	Key-lock function	Function that prevents changes to the settings of the Pressure switch (disables button operation).
L	Load impedance	Refer to "Max. load impedance".
M	Manual setting	Manual pressure setup without using auto preset. This term is used to distinguish between manual and auto preset pressure setup.
	Master Pressure switch	A Pressure switch whose settings are copied when using the copy function.
	Maximum applied voltage	The maximum voltage that can be connected to the output of an NPN device.
	Maximum load current	The maximum current that can flow to the output (output line) of the switch output.
	Max. (Min.) load impedance	The maximum (minimum) load (resistance value and impedance) which can be connected to the output (output wire) of the analog current output.
	Measurement mode	Operating condition in which pressure is being detected and displayed, and the switch function is working.
	Min. setting unit	Refer to "digit".
N	Normal output	One of the switch output types. In hysteresis mode the switch output is turned ON when pressure equal to or greater than the switch output set value is detected. In window comparator mode, the switch output is turned ON when pressure between the switch output set values (P1L to P1H) is detected. (Refer to the "List of output modes" on page 33.)

	Term	Definition
O	Operation light	A light that turns on when the switch output is ON.
	Operation mode	Hysteresis mode, window comparator mode, Error output or Output off can be selected.
	Output impedance	The resistance value of a component between the voltage output element and the analog voltage output. It is indicated as a resistance value which is converted in accordance with the condition in which resistance is directly connected to the voltage output element. There may be an error in the output voltage depending on this output impedance and the input impedance of customers' equipment. (example: If the Pressure switch with output impedance of 1kΩ is connected to the A/D converter to detect the analog output of 5V, the detected voltage by the A/D converter becomes $5(V) \times 1(M\Omega)/(1(k\Omega) + 1(M\Omega)) \doteq 4.995(V)$, and there is an error of approximate 0.005 V).
	Output style	The operation principle of the switch output. Normal output and reverse output can be selected. Please refer to the "List of output modes" on page 33 operating conditions.
P	Peak value display (mode)	Shows the maximum pressure from when the power was supplied to the current time.
	Port size	The diameter of the connecting part of the switch for connecting with the object to be measured.
	Power saving mode	Operating mode in which the digital display turns off and power consumption is reduced.
	Pressure setting	The set pressure value that determines the point at which the pressure switch turns ON and OFF.
	Proof pressure	Pressure limit that if exceeded will result in mechanical and/or electrical damage to the product.
R	R.D.	Current read value For example, when the display value is 1.000[MPa], $\pm 5\%$ R.D. is $\pm 5\%$ of 1.000[MPa], which becomes ± 0.05 [MPa]. When the display value is 0.800[MPa], $\pm 5\%$ R.D. is $\pm 5\%$ of 0.800[MPa], which becomes ± 0.04 [MPa].
	Rated pressure range	The pressure range within which the product will meet all published specifications. Values outside of this range can be set as long as they are within the set pressure range, but the specifications cannot be guaranteed.
	Repeatability	Variation in repeated measurement of pressure display or ON-OFF output point when the pressure changes at 25 centigrade.
	Residual voltage	The difference between the ideal ON voltage and the actual voltage when the switch output is on. Varies with load current. Ideally should be 0 V.
	Resolution	Refer to "Display resolution".
	Reversed output	One of the switch output types. In hysteresis mode the switch output is turned ON when pressure less than or equal to the switch output set value is detected. In window comparator mode, the switch output is turned ON when pressure is outside the switch output set values (n1L to n1H) is detected. (Refer to the "List of output modes" on page 33.)
	Ripple	A type of chattering.

	Term	Definition
S	Set pressure range	The pressure range that can be set for switch output.
	Slave Pressure switch	A Pressure switch whose settings are copied to when using the copy function.
	Switch output	Sometimes referred to as "ON-OFF output".
U	Units selection function	A function to change the units in which the measured pressure value is displayed. The display units can only be changed if the product is equipped this function. It is not possible to purchase the product with this function if the product is used in Japan. The product for Japan is displayed in SI only.
W	Window comparator mode	An operating mode in which the switch output is turned on and off depending on whether the flow is inside or outside the range of two set values. (Refer to the "List of output modes" on page 33.)
	Withstand voltage	A measure of the product's resistance to a voltage applied between the electrical circuit and case. Durability in withstanding voltage. The product may be damaged if a voltage over this value is applied. (The withstand voltage is not the supply voltage used to power the product.)
Z	Zero-clear function	This function to adjust the displayed pressure to zero.

Mounting and Installation

■ Installation

○ Mounting

- Mount the optional bracket and panel mount adapter to the pressure switch.
- When the pressure switch is to be mounted in a place where water and dust splashes occur, insert a tube into the atmospheric vent port of the pressure switch.
(Refer to “Tube attachment” on page 18.)

○ Mounting with bracket

- Mount the bracket to the body with mounting screws (Self tapping screws: Nominal size 3 x 8L (2 pcs)), then set the body to the specified position.

*: Tighten the bracket mounting screws to a torque of 0.5 ± 0.05 Nm.

Self tapping screws are used, and should not be re-used several times.

- Bracket A (Part No.: ZS-46-A1)

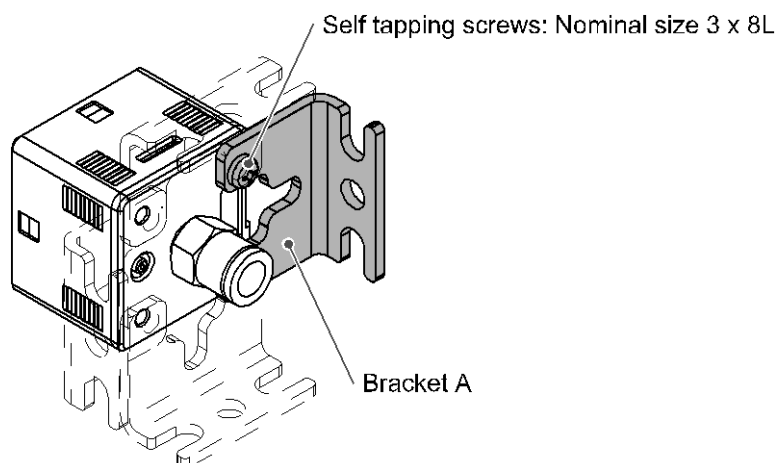

- Bracket B (Part No.: ZS-46-A2)

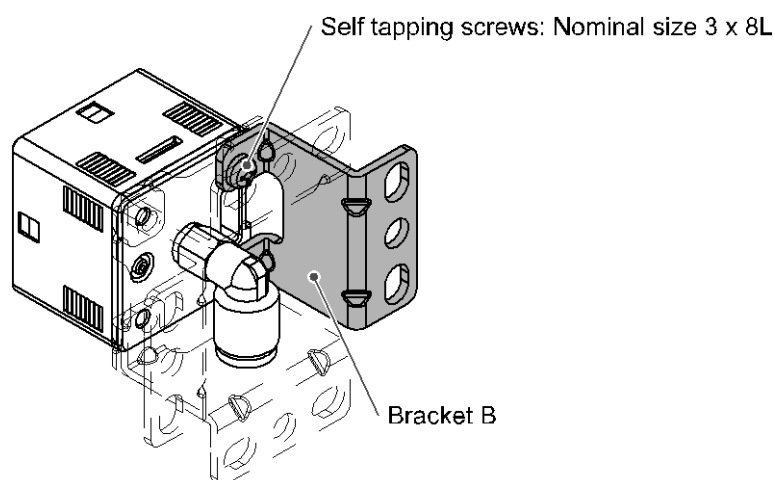

○ Mounting with panel mount adapter

- Mount part (a) to the front of the body and fix it. Then insert the body with (a) into the panel until (a) comes into contact with the panel front surface. Next, mount part (b) to the body from the rear and insert it until (b) comes into contact with the panel for fixing.

- Panel mount adapter (Part No.: ZS-46-B)

Panel mount adapter + Front protective cover (Part No.: ZS-46-D)

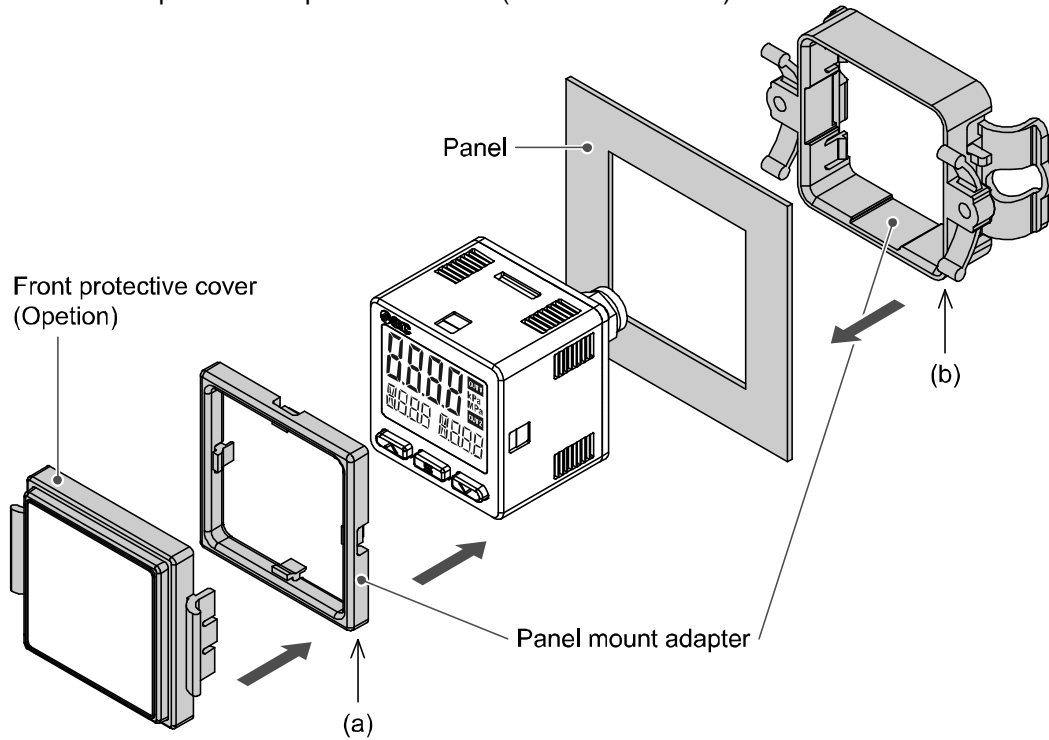

*: The panel mount adapter can be rotated through 90 degrees for mounting.

How to remove the panel mount adapter

- When removing the digital pressure switch with panel mount adapter from the installation, pull it forward while expanding the hooks on each side as shown below. If the panel mount adapter is pulled forward with the hook caught, the product and the adapter may be damaged.

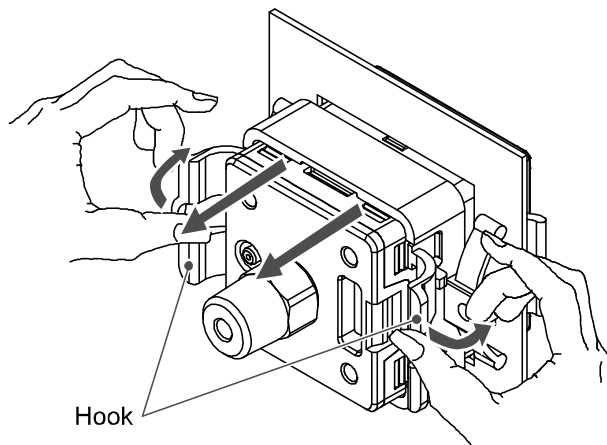

■Piping

○Tightening the connection thread

- For connecting to the body (piping specification: -M5)

After hand tightening, apply a spanner of the correct size to the spanner flats of the piping body, and tighten with a 1/6 to 1/4 rotation.

As a reference, the tightening torque is 1 to 1.5 Nm.

(When replacing the piping adapter ZS-46-N*, tighten it using the same method.)

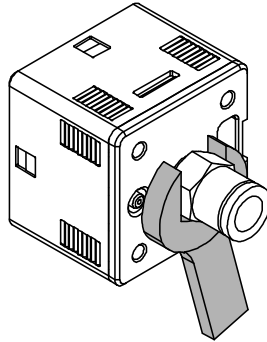

- Piping specification: -01, -N01

After hand tightening, hold the hexagonal spanner flats of the pressure port with a spanner, and tighten with 2 to 3 rotations.

As a reference, the tightening torque is 3 to 5 Nm.

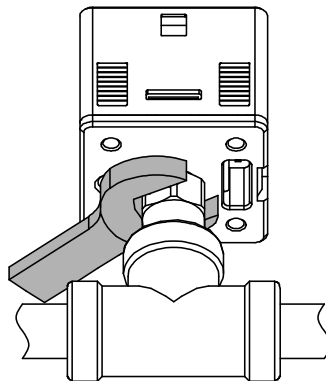

When tightening, do not hold the pressure switch body with a spanner.

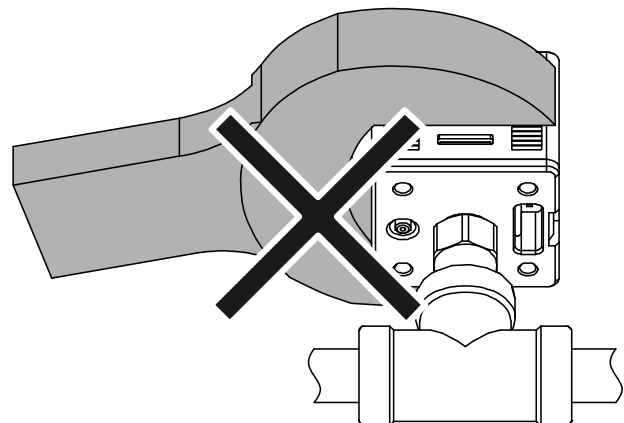
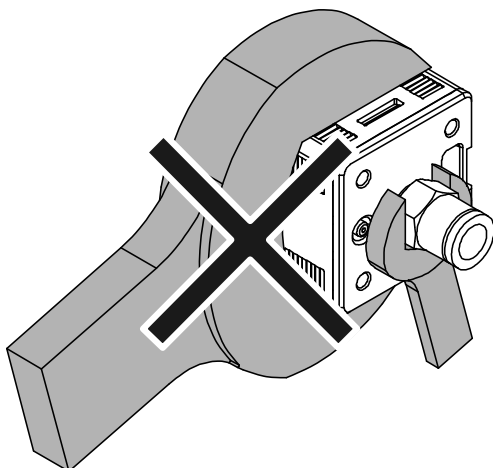

○Tube attachment

- When the pressure switch is used in a place where water and dust splashes may occur, insert a tube in the atmospheric vent port, and position the other end of the tube at safe position to protect the vent port from water and dust (see the figure bottom).

*: The tube should be inserted to the end of the atmospheric vent port.

*: SMC TU0425 (polyurethane, O.D ϕ 4, I.D ϕ 2.5) is a suitable tubing.

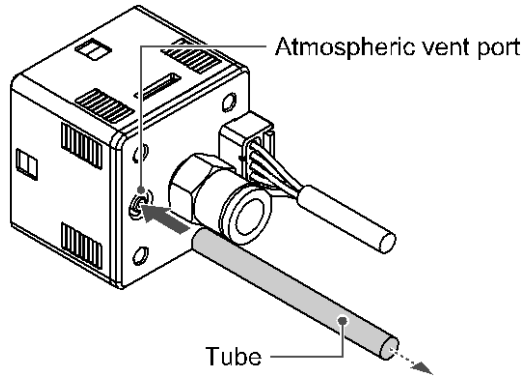

To a safe position to protect from water and dust.

■Wiring

○Wiring connections

- Connections should be made with the power supply turned off.
- Use a separate route for the product wiring and any power or high voltage wiring. Otherwise, malfunction may result due to noise.
- If a commercially available switching power supply is used, be sure to ground the frame ground (FG) terminal. If the switching power supply is connected for use, switching noise will be superimposed and it will not be able to meet the product specifications. In that case, insert a noise filter such as a line noise filter/ferrite between the switching power supplies or change the switching power supply to the series power supply.

○How to use connector

Connector attachment/detachment

- When connecting the connector, insert it straight onto the pins, holding the lever and connector body, and lock the connector by pushing the lever hook into the concave groove on the housing.
- To detach the connector, remove the hook from the groove by pressing the lever downward, and pull the connector straight out.

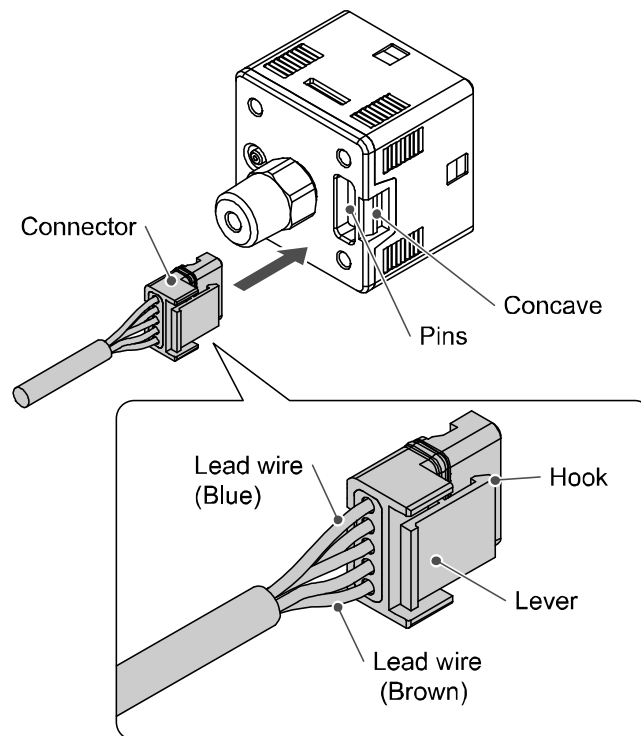

Connector pin numbers

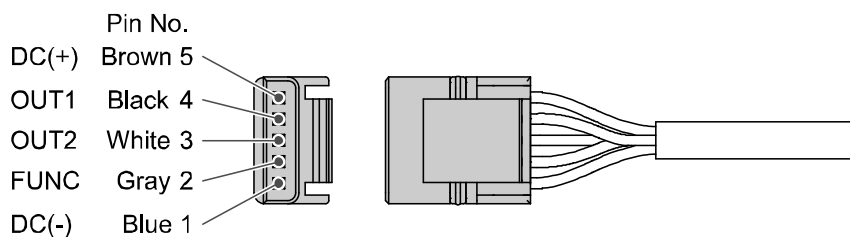

○ Internal circuit and wiring examples

Z/ISE20B(F)-□-□-□-□□□

● Output specification

-S/-R

(Analog output mode)

Switch output

NPN open collector output type-2 output

Max. 28 V, 80 mA

Residual voltage 1 V or less

R: Analog output 1 to 5 V

Output impedance 1 k Ω

S: Analog output 4 to 20 mA

Max. load impedance

Power supply voltage 12 V: 300 Ω

Power supply voltage 24 V: 600 Ω

Min. load impedance 50 Ω

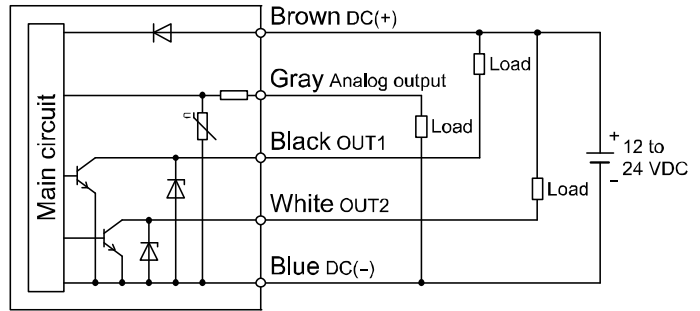

-S/-R

(Auto-shift input mode)

With auto-shift switch output

NPN open collector output type-2 output

Max. 28 V, 80 mA

Residual voltage 1 V or less

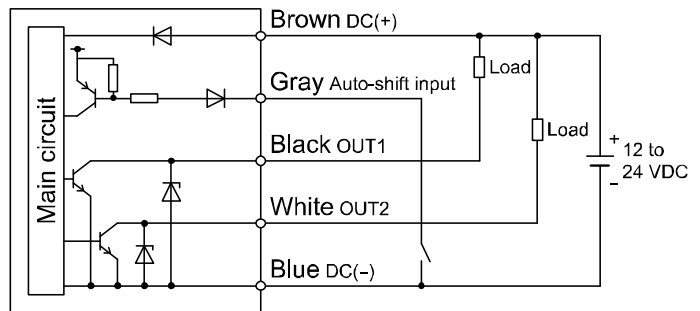

-X

(Copy function switch output)

-S/-R

(Copy input mode)

NPN open collector output type-2 output

Max. 28 V, 80 mA

Residual voltage 1 V or less

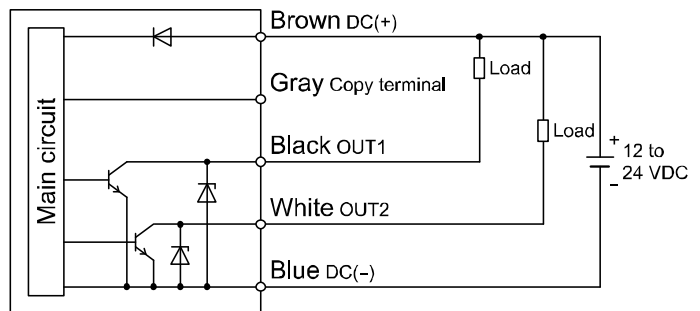

-V/-T

(Analog output mode)

Switch output

PNP open collector output type-2 output

Max. 80 mA

Residual voltage 1 V or less

T: Analog output 1 to 5 V

Output impedance 1 k Ω

V: Analog output 4 to 20 mA

Max. load impedance

Power supply voltage 12 V: 300 Ω

Power supply voltage 24 V: 600 Ω

Min. load impedance 50 Ω

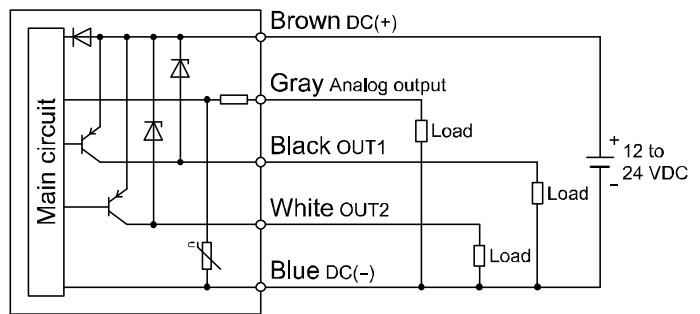

-V/-T

(Auto-shift input mode)

With auto-shift switch output

PNP open collector output type-2 output

Max. 80 mA

Residual voltage 1 V or less

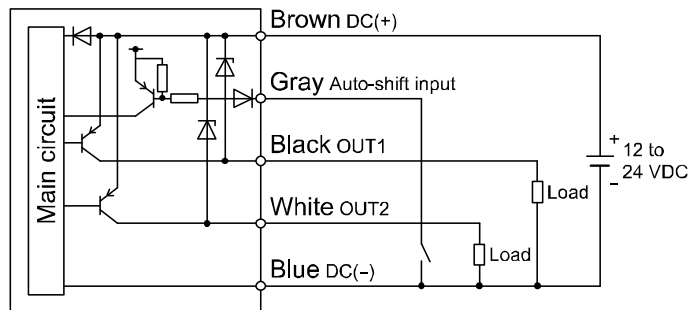

-Y

(Copy function switch output)

-V/-T

(Copy input mode)

PNP open collector output type-2 output

Max. 28 V, 80 mA

Residual voltage 1 V or less

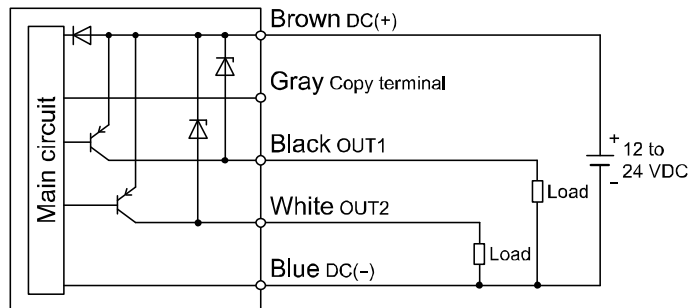

Outline of Settings [Measurement mode]

Power is supplied.



The product code is displayed for approximately 3 sec. after supplying power.

*: Within approximately 0.2 second after power-on, the switch starts.



[Measurement mode]

Detects the pressure after power is supplied, and indicates the display and switch operating status. This is the basic mode; other modes should be selected for set-point changes and other function settings.

Measurement mode screen

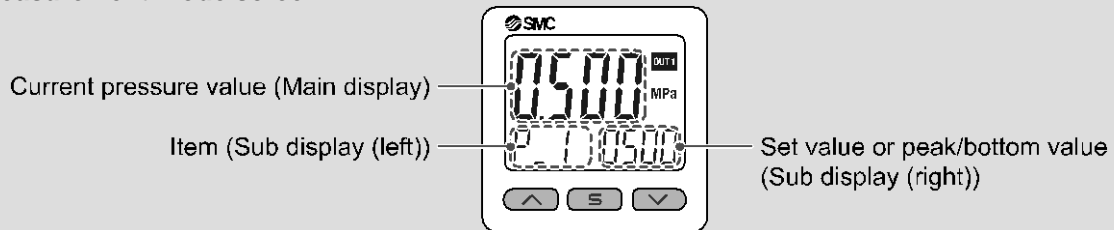

Sub display

In measurement mode, the display of the sub display can be temporarily changed by pressing the or buttons.

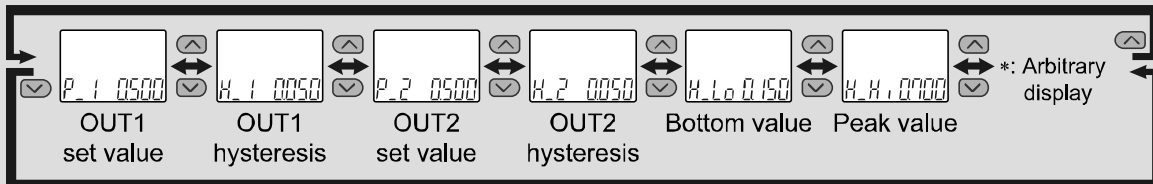

*: One arbitrary display mode can be added to the sub display by setting the [F10] sub display setting.

If the sub display is switched during the arbitrary display setting, the display will be returned to the arbitrary display 30 seconds later. (The default setting does not include arbitrary display.)

Press the button once.

Press the button between 1 and 3 sec.

Press the button between 3 and 5 sec.



Set either of set value or hysteresis.
(3 step setting mode)
(Refer to page 24.)

Select the set value, hysteresis and delay time.
(Simple setting mode)
(Refer to page 26.)

Change the function settings.
(Function selection mode)
(Refer to page 28.)

Other Settings
•Zero-clear function
•Key-lock function
(Refer to page 61.)

*: The outputs will continue to operate during setting.

*: If a button operation is not performed for 3 seconds during the setting, the display will flash.

(This is to prevent the setting from remaining incomplete if, for instance, an operator were to leave during setting.)

*: 3 step setting mode, simple setting mode and function selection mode settings are reflected each other.

Pressure Setting

Default settings

When the pressure exceeds the set value, the switch will be turned on. When the pressure falls below the set value by the amount of hysteresis or more, the switch will be turned off. The default setting is to turn on the pressure switch when the pressure reaches the centre of the atmospheric pressure and upper limit of the rated pressure range. If this condition, shown to the below, is acceptable, then keep these settings.

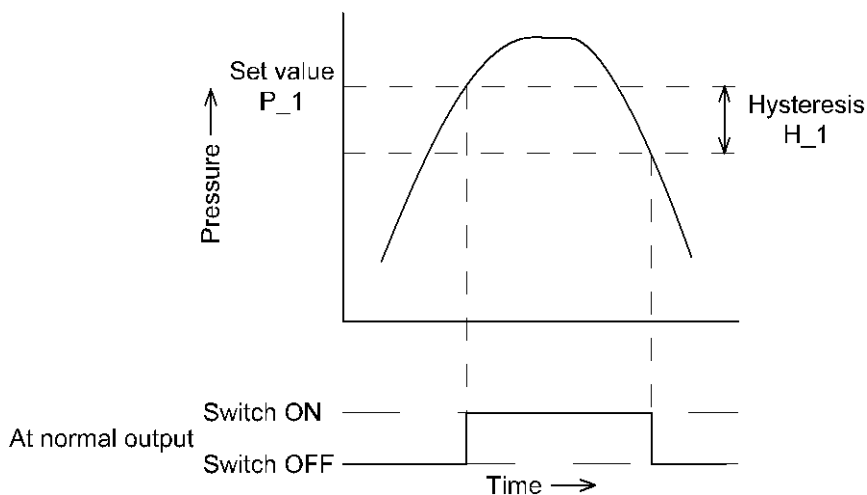

●ISE20B

Item	Default setting
[P_1] Set value of OUT1	0.500 MPa
[H_1] Hysteresis of OUT1	0.050 MPa

Item	Default setting
[P_2] Set value of OUT2	0.500 MPa
[H_2] Hysteresis of OUT2	0.050 MPa

●ZSE20B

Item	Default setting
[P_1] Set value of OUT1	-50.5 kPa
[H_1] Hysteresis of OUT1	5.1 kPa



Item	Default setting
[P_2] Set value of OUT2	-50.5 kPa
[H_2] Hysteresis of OUT2	5.1 kPa

●ZSE20BF

Item	Default setting
[P_1] Set value of OUT1	50.0 kPa
[H_1] Hysteresis of OUT1	5.0 kPa

Item	Default setting
[P_2] Set value of OUT2	50.0 kPa
[H_2] Hysteresis of OUT2	5.0 kPa

Zero-clear of display

The display is reset to zero when the  and  buttons are pressed simultaneously for 1 second. For the first operation, perform a zero-clear without pressure at measurement mode.

3 Step Setting Mode

3 step setting mode



In this mode, the set values can be input in just 3 steps.

Use this mode if the product is to be used straight away, after changing only the set values.

(The current pressure value is displayed on the main display.)





<Operation>

[3 step setting mode (hysteresis mode)]

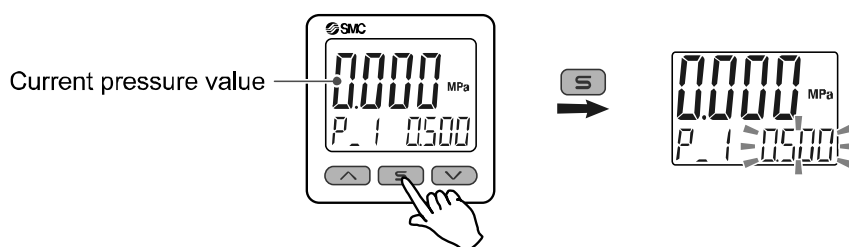
In the 3 step setting mode, the set value (P_1 or n_1, P_2 or n_2) and hysteresis (H_1 or H_2) can be changed. Set the items on the sub display (set value or hysteresis) with  or  button. When changing the set value, follow the operation below. The hysteresis setting can be changed in the same way.

- (1) Press the  button once when the item to be changed is displayed on the sub display. The set value on the sub display (right) will start flashing.





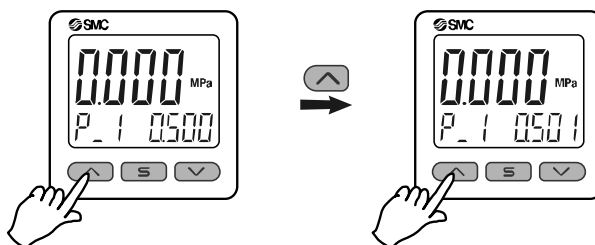

- (2) Press the  or  button to change the set value. The set value can be increased with  button and can be reduced with  button.

- Press the  button once to increase the value by one digit, press and hold to continuously increase.

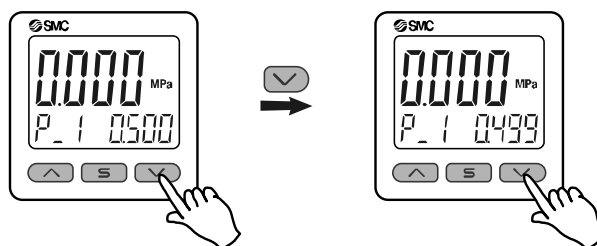

- Press the  button once to reduce the value by one digit, press and hold to continuously reduce.



- When the  and  buttons are pressed and held simultaneously for 1 second or longer, the set value is displayed as [- - -], and the set value will be the same as the current pressure value automatically (snap shot function (Refer to page 61.)). Afterwards, it is possible to adjust the value by pressing the  or  button.

- (3) Press the  button to complete the setting.

The Pressure switch turns on within a set pressure range (from P1L to P1H) during window comparator mode. Set P1L, the lower limit of the switch operation, and P1H, the upper limit of the switch operation and WH1 (hysteresis) following the instructions given on page 24.

(When reversed output is selected, the sub display (left) shows [n1L] and [n1H].)

Please refer to the "List of output modes" on page 33 for the relationship between the set values and operation.

*: Set OUT2 in the same way.

Setting of the normal/reverse output switching and hysteresis/window comparator mode switching are performed with the function selection mode [F 1] Setting of OUT1 or [F 2] Setting of OUT2.

Simple Setting Mode



<Operation>

[Simple setting mode (hysteresis mode)]

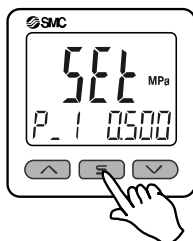

In the simple setting mode, the set value, hysteresis and delay time can be changed while checking the current pressure value (main display).

- (1) Press and hold the  button between 1 and 3 seconds in measurement mode. [SEt] is displayed on the main display. When the button is released while in the [SEt] display, the current pressure value is displayed on the main display, [P_1] or [n_1] is displayed on the sub display (left), and the set value is displayed on the sub display (right) (Flashing).



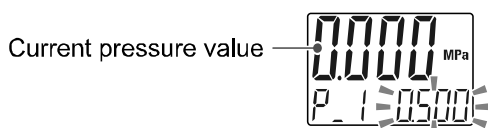

- (2) Change the set value with  or  button, and press the  button to set the value. Then, the setting moves to hysteresis setting. (The snap shot function can be used. (Refer to page 61.))





- (3) Change the set value with  or  button, and press the  button to set the value. Then, the setting moves to the delay time of the switch output. (The snap shot function can be used. (Refer to page 61.))



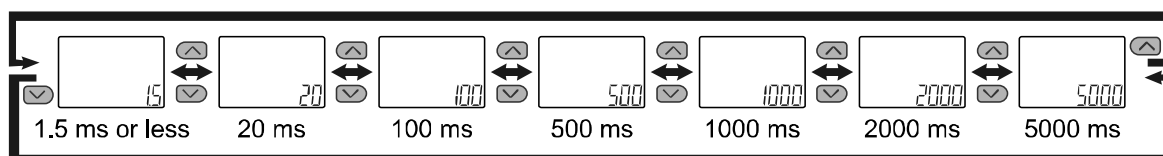
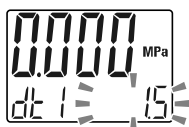

- (4) Press the  or  button, the delay time of the switch output can be selected. Delay time setting can prevent the output from chattering.



- (5) Press the  button for 2 seconds or longer to complete the setting. If the button is pressed for less than 2 seconds, the setting will move to the OUT2 setting.

*1: Selected items (1) to (4) become valid after pressing the  button.

*2: After enabling the setting by pressing the  button, it is possible to return to measurement mode by pressing the  button for 2 seconds or longer.

*3: When the output mode (refer to page 31) is set to error output or output OFF, the simple setting mode cannot be used. (The setting changes to measurement mode by releasing the button when [SEt] is displayed.)

*4: When OUT2 set items are displayed on the sub screen of the measurement mode, step (1) will begin with the OUT2 setting [P_2] or [n_2].

In the window comparator mode, set P1L, the lower limit of the switch operation, and P1H, the upper limit of the switch operation, WH1 (hysteresis) and dt1 (delay time) following the instructions given on page 26. (When reversed output is selected, the sub display (left) shows [n1L] and [n1H].) Please refer to the "List of output modes" on page 33 for the relationship between the set values and operation.

*: Set OUT2 in the same way.

Function Selection Mode

■Function selection mode

In measurement mode, press the **[S]** button between 3 and 5 seconds, to display [F 0]. Select to display the function to be changed [F□□]. Press and hold the **[S]** button for 2 seconds or longer in function selection mode to return to measurement mode.

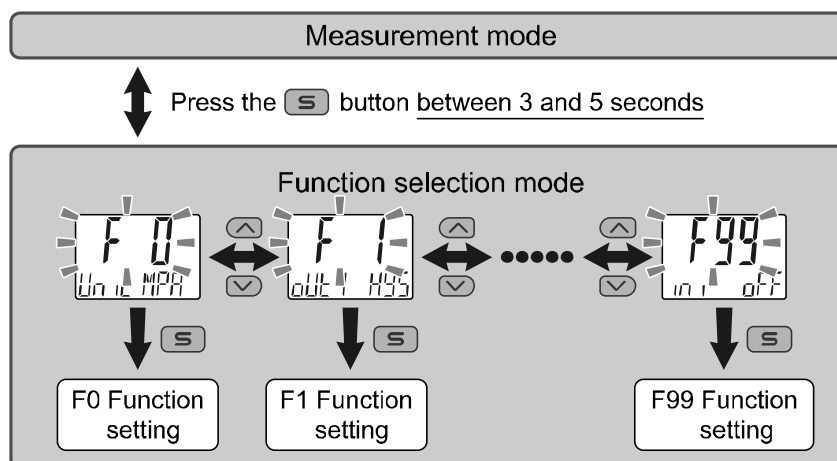

*: Some products do not have all the functions. If no function is available or selected due to configuration of other functions, [- -] is displayed on the sub display (right).

■Default setting

The default setting is as follows.

If no problem is caused by this setting, keep these settings.

To change a setting, enter function selection mode.

●[F 0] Units selection function ➡ Page 30

Units specification	Pressure range	Default setting
"Nil" or M	ISE20B	MPa
	ZSE20B(F)	kPa
P	ISE20B	psi
	ZSE20B(F)	

●[F 1] Setting of OUT1 ➡ Page 31

Item	Explanation	Default setting
Output mode	Either hysteresis mode, window comparator mode, error output or output off can be selected.	Hysteresis mode
Reversed output	Selects which type of switch output is used, normal or reversed.	Normal output
Pressure setting	Sets the ON and OFF point of the switch output.	ISE20B : 0.500 MPa ZSE20B : -50.5 kPa ZSE20BF: 50.0 kPa
Hysteresis	Appropriate setting of the hysteresis will prevent the switch output from chattering.	ISE20B : 0.050 MPa ZSE20B : 5.1 kPa ZSE20BF: 5.0 kPa
Delay time	Delay time of the switch output can be selected.	1.5 ms or less
Display color	Selects the output according to the display color.	OUT1 ON : Green OUT1 OFF: Red

●[F 2] Setting of OUT2 ➡ Page 34

Same setting as [F 1] OUT1.

●Other parameter settings

Item	Page	Default setting
[F 3] Digital filter setting	Page 36	0 ms
[F 4] Auto-preset function	Page 37	Not used
[F 5] FUNC terminal setting	Page 39	Analog output *
[F 6] Fine adjustment of display value	Page 41	0%
[F10] Sub display setting	Page 42	std (Standard)
[F11] Display resolution setting	Page 48	1000-split
[F80] Power saving mode	Page 49	OFF
[F81] Security code	Page 50	OFF
[F82] Input of line name	Page 52	AAAA
[F90] Setting of all functions	Page 53	OFF
[F96] Input signal check	Page 55	No configurable items
[F97] Selection of copy check	Page 56	OFF
[F98] Output check	Page 58	N/A (normal output)
[F99] Reset to default settings	Page 60	OFF

*: For output specifications X and Y, "---" is displayed.

■ [F 0] Units selection function

This setting is only available for models with the units selection function.
The unit that can be displayed is different depending on the pressure range.
(kPa/MPa can still be selected if the product does not have the units selection function.)

<Operation>

Press the  or  button in function selection mode to display [F 0].

Press the  button.  Move on to display unit selection.

Display unit selection

Press the  or  button to select the display unit.

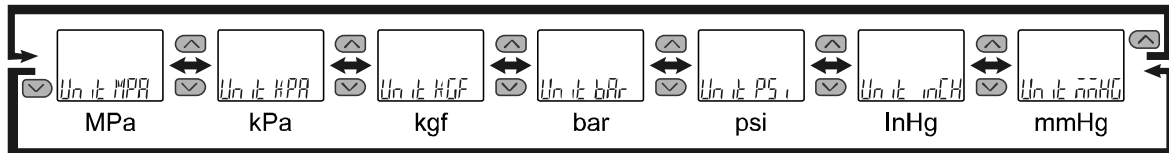

Press the  button to set.  Return to function selection mode.

[F 0] Units selection function completed

● Available display unit and minimum set value

Unit	ZSE20BF	ZSE20B	ISE20B
MPa	0.001	0.001	0.001
kPa	0.1	0.1	1
kgf/cm ²	0.001	0.001	0.01
bar	0.001	0.001	0.01
psi	0.02	0.01	0.1
InHg	0.1	0.1	-
mmHg	1	1	-

■[F 1] Setting of OUT1

Set the output mode of OUT1.

Output turns on when the pressure is greater than the set value. The default setting is to turn on the pressure switch when the pressure reaches the centre of the atmospheric pressure and upper limit of the rated pressure range.

The display color changes according to the OUT1 output status. It will turn Green when the output is ON and it will be Red when the output is OFF.

Please refer to the "List of output modes" on page 33 for the relationship between the set items and operation.

<Operation>

Press the or button in function selection mode to display [F 1].

Press the button. Move on to output mode setting.

Output mode setting

Press the or button to select the required output mode.

OUT 1 HYS

Hysteresis

OUT 1 WIND

Window comparator

OUT 1 Err

Error output

OUT 1 OFF

Output OFF

Press the button to set. Move on to reversed output setting.

Reversed output setting

Press the or button to select the reversed output.

lot 1 LP

Normal output

lot 1 Ln

Reversed output

Press the button to set. Move on to pressure setting.

Pressure setting

Set the pressure based on the setting method on page 24.

Hysteresis mode: [P_1]
 Window comparator mode: [P1L] [P1H]
 "P" is changed to "n" as [P_1] → [n_1] when reversed output is selected.
 The snap shot function can be used.
 (Refer to page 61.)

[Err] Error output is selected

Press the button to move on to display color setting.

Press the button to set. Move on to hysteresis setting.

[OFF] Output off is selected
 Press the button to move on to display color setting.

Hysteresis setting

Set the pressure referring to the setting method on page 24.



Hysteresis mode: [H_1]
Window comparator mode: [WH1]
The snap shot function can be used. (Refer to page 61.)

Press the button to set. Move on to delay time setting.

Delay time setting

Set the delay time referring to the setting method on page 26.



Press the button to set. Move on to display color setting.

Display color setting

Press the or button to select the display color.



[Col 1500]	[Col 1500]	[Col 2500]	[Col 2500]	[Col red]	[Col grn]				
ON: Green OFF: Red (Linked to OUT1)	ON: Red OFF: Green (Linked to OUT1)	ON: Green OFF: Red (Linked to OUT2)	ON: Red OFF: Green (Linked to OUT2)	Normally: Red	Normally: Green				

Press the button to set. Return to function selection mode.

[F 1] Setting of OUT1 completed

*1: Selected item becomes valid after pressing the button.

*2: After enabling the setting by pressing the button, it is possible to return to the measurement mode by keeping pressing the button for 2 seconds or longer.

•List of output modes

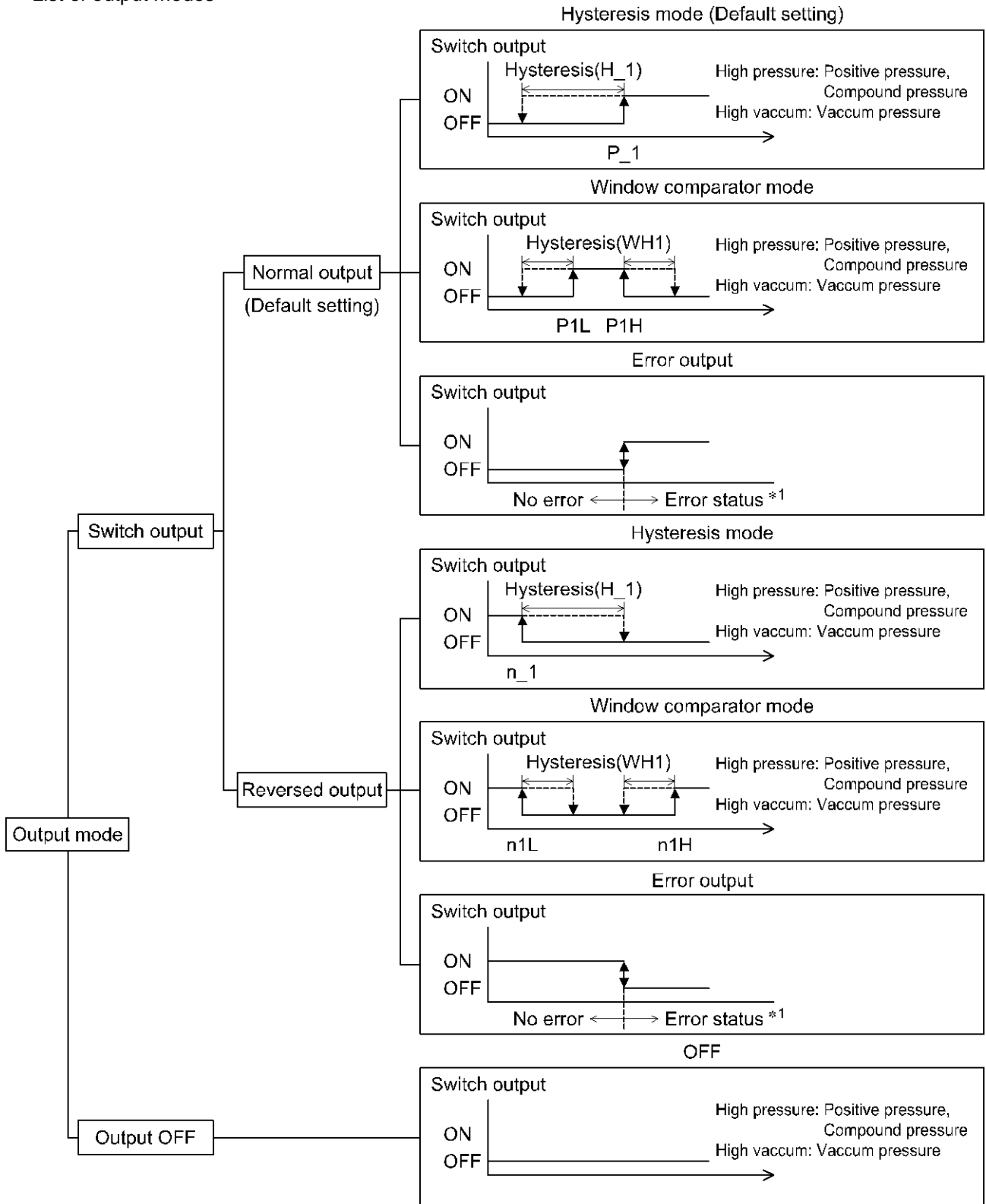

*1: The applicable errors are Er0, 4 to 6, 8, 9, o.r as well as Er1 or 2 (excluding the error output).

*: The chart above shows the OUT1 operation. For OUT2, all "1" in the chart will be changed to "2". (example $P_1 \rightarrow P_2$)

If the point at which the switch output changes is outside of the set pressure range due to the selection of normal or reversed output, the hysteresis value is automatically adjusted.

■[F 2] Setting of OUT2

Set the output mode of OUT2.

Output turns on when the pressure is greater than the set value. The default setting is to turn on the pressure switch when the pressure reaches the centre of the atmospheric pressure and upper limit of the rated pressure range.

Please refer to the "List of output modes" on page 33 for the relationship between the set items and operation.

<Operation>

Press the or button in function selection mode to display [F 2].

Press the button. Move on to output mode setting.

Output mode setting

Press the or button to select the required output mode.

OUT2 HYS
Hysteresis

OUT2 W ind
Window comparator

OUT2 Err
Error output

OUT2 off
Output OFF

Press the button to set. Move on to reversed output setting.

Reversed output setting

Press the or button to select the reversed output.

OUT2 P
Normal output

OUT2 n
Reversed output

[OFF] Output off is selected
Press the button to move on to display color setting.

Press the button to set. Move on to pressure setting.

Pressure setting

Set the pressure based on the setting method on page 24.

Hysteresis mode: [P_2]
Window comparator mode: [P2L] [P2H]
"P" is changed to "n" as [P_2] → [n_2] when reversed output is selected.
The snap shot function can be used.
(Refer to page 61.)

[Err] Error output is selected
Press the button to move on to display color setting.

Press the button to set. Move on to hysteresis setting.

Hysteresis setting

Set the pressure referring to the setting method on page 24.



Hysteresis mode: [H_2]
Window comparator mode: [WH2]
The snap shot function can be used. (Refer to page 61.)

Press the button to set. Move on to delay time setting.

Delay time setting

Set the delay time referring to the setting method on page 26.



Press the button to set. Move on to display color setting.

Display color setting

Press the or button to select the display color.



[Col 15or]	[Col 15or]	[Col 25or]	[Col 25or]	[Col red]	[Col grn]	[Col 15or]	[Col 15or]	[Col 25or]	[Col 25or]
ON: Green	ON: Red	ON: Green	ON: Red	Normally: Red	Normally: Green	ON: Green	ON: Red	ON: Green	ON: Red
OFF: Red	OFF: Green	OFF: Red	OFF: Green			OFF: Red	OFF: Green	OFF: Red	OFF: Green
(Linked to OUT1)	(Linked to OUT1)	(Linked to OUT2)	(Linked to OUT2)			(Linked to OUT2)	(Linked to OUT2)	(Linked to OUT2)	(Linked to OUT2)

Press the button to set. Return to function selection mode.

[F 2] Setting of OUT2 completed

*1: Selected item becomes valid after pressing the button.



*2: After enabling the setting by pressing the button, it is possible to return to the measurement mode by keeping pressing the button for 2 seconds or longer.

■[F 3] Digital filter setting



The Digital filter can be selected to filter the pressure measurement.
Output chattering or flicker in the measurement mode display can be reduced by setting the digital filter.

<Operation>

Press the  or  button in function selection mode to display [F 3].

Press the  button.  Move on to digital filter setting.

Digital filter setting

Press the  or  button to select the digital filter.

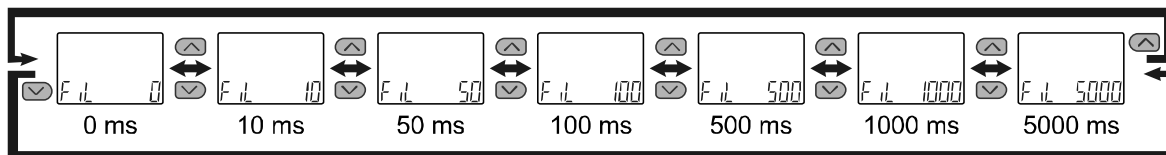

Press the  button to set.  Return to function selection mode.

[F 3] Digital filter setting completed

*1: Each set value is a guideline for 90% response time.

*2: Both the switch output and pressure display are affected. When only switch output needs to be affected, select the delay time setting (page 26, 32 and 35).

■[F 4] Auto-preset function



This function will automatically calculate and set the optimum pressure based on the actual operating condition, when hysteresis mode has been selected.

<Operation>

Press the  or  button in function selection mode to display [F 4].

Press the  button.  Move on to Auto-preset function.

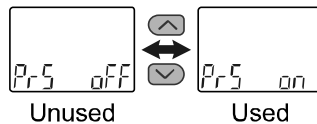

Auto-preset function

Press the  or  button to select the auto-preset function.



Press the  button to set.  Return to function selection mode.

[F 4] Auto-preset function completed

Press the  button in measurement mode to perform the pressure setting.
Then, press the  button again to change the pressure while the display is flashing.
(Refer to page 38 for details.)

●Auto-preset

When auto-preset is selected in function selection mode, the set value can be calculated and memorized from the measured pressure. Repeating the suction and release of the workpiece to be set for several times will automatically optimize the set value.

(1) Selection of auto-preset OUT1 mode

Press the **S** button in measurement mode to display [AP1 REdY].
 (If setting of OUT1 is not necessary, select [AP1 REdY], and then press the **▲** and **▼** buttons simultaneously for 1 second or longer.
 The display will move to [AP2 REdY].



Auto-preset is ready

(2) Preparation of equipment for OUT1

Prepare the equipment for which the pressure of OUT1 is to be set.

(3) Setting of auto-preset for OUT1

Press the **S** button, [AP1 RUn] will be displayed.
 Measurement starts. Operate the device to change the pressure.
 (If the **▲** and **▼** buttons are pressed simultaneously for 1 second or longer while [AP1 RUn] is displayed, measurement will be stopped and [AP2 REdY] will return).



Auto-preset is being set

(4) Selection of auto-preset OUT2 mode

Press the **S** button to set [P_1],[H_1] ([n_1],[H_1] in reverse output mode) to display [AP2 REdY].
 (If the setting of OUT2 is not necessary, press the **▲** and **▼** buttons simultaneously for 1 second or longer after [AP2 REdY] display. The display will move to measurement mode).

(5) Preparation of equipment for OUT2

Prepare equipment for which the pressure of OUT2 is to be set, and set the value of OUT2 as in OUT1.
 [AP2 RUn] will be displayed and measurement will start.
 (If the **▲** and **▼** buttons are pressed simultaneously for 1 second or longer while "AP2 RUn" is displayed, measurement will be stopped and measurement mode will return).

(6) Complete setup

Press the **S** button to set the set value of [P_2] and [H_2] and complete the auto-preset mode. Then, measurement mode returns.
 ([n_2], [H_2] in reverse output mode.)

The settings in auto-preset will be as follows in OUT1.

<p>•Normal output</p> <p>$P_1 = A - (A - B)/4$</p> <p>$H_1 = (A - B)/2$</p>	<p>•Reversed output</p> <p>$n_1 = B + (A - B)/4$</p> <p>$H_1 = (A - B)/2$</p>	<p>A = Maximum pressure</p> <p>B = Minimum pressure</p>
-----------------------------------------------------------------------------------------------------	-------------------------------------------------------------------------------------------------------	---------------------------------------------------------

In the OUT2 setting, the above P_1, n_1 and H_1 will be P_2, n_2 and H_2 respectively.

If setting is not necessary press the **▲** and **▼** buttons simultaneously for 1 second or longer.

■[F 5] FUNC terminal setting

When the product with analog output/auto shift input function is used, the FUNC terminal setting can be selected.

Analog output: Outputs proportional output according to the applied pressure.

Auto-shift: The display indicates the change of relative flow from the reference value.

Auto-shift zero: The display is set to zero when the signal is input, and therefore the display indicates the change of relative flow from the reference value.

Copy input: Copies the set value. Refer to "[F97] Selection of copy function" on page 56.

<Operation>

Press the  or  button in function selection mode to display [F 5].

Press the  button.  Move on to FUNC terminal setting.

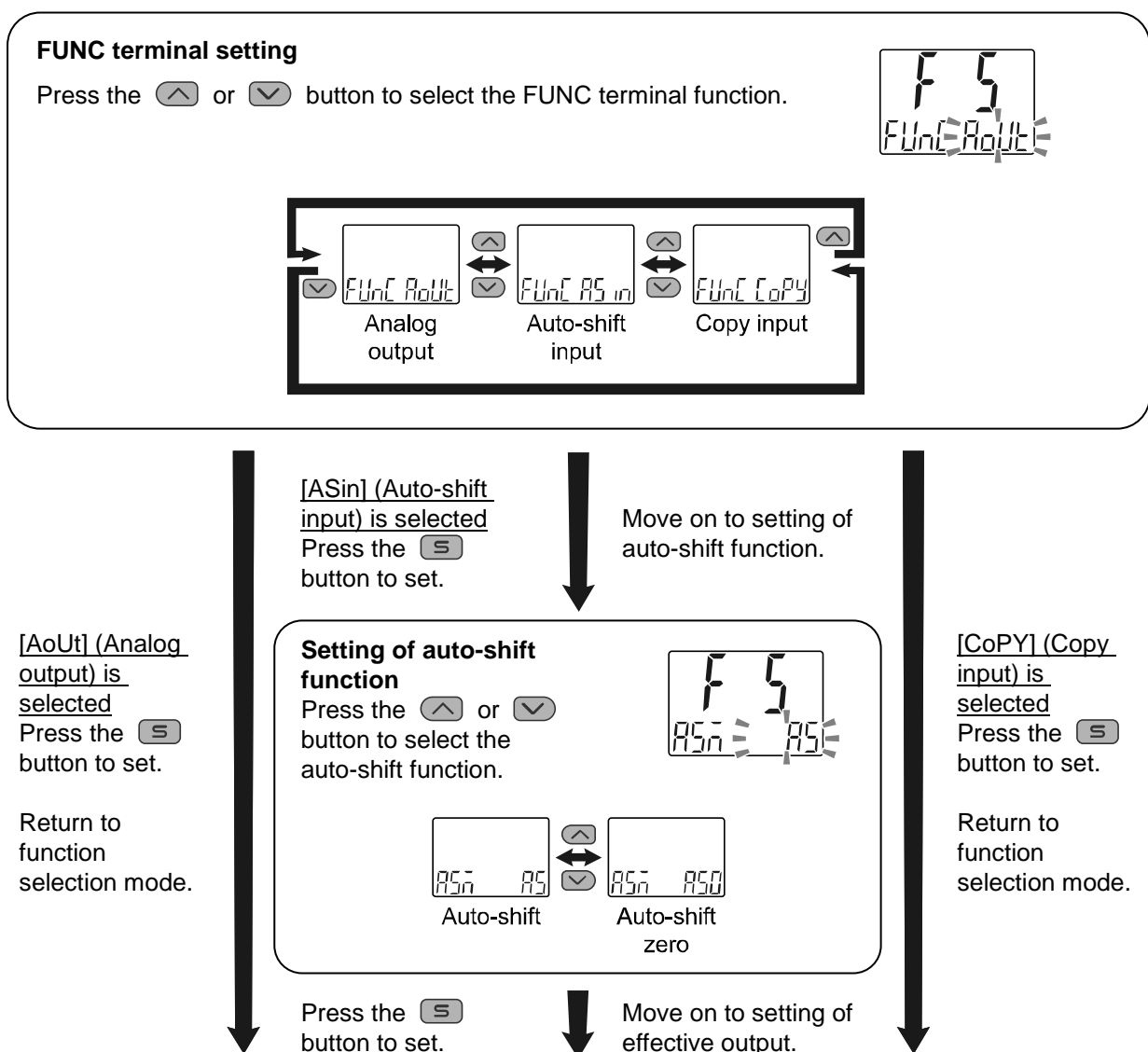

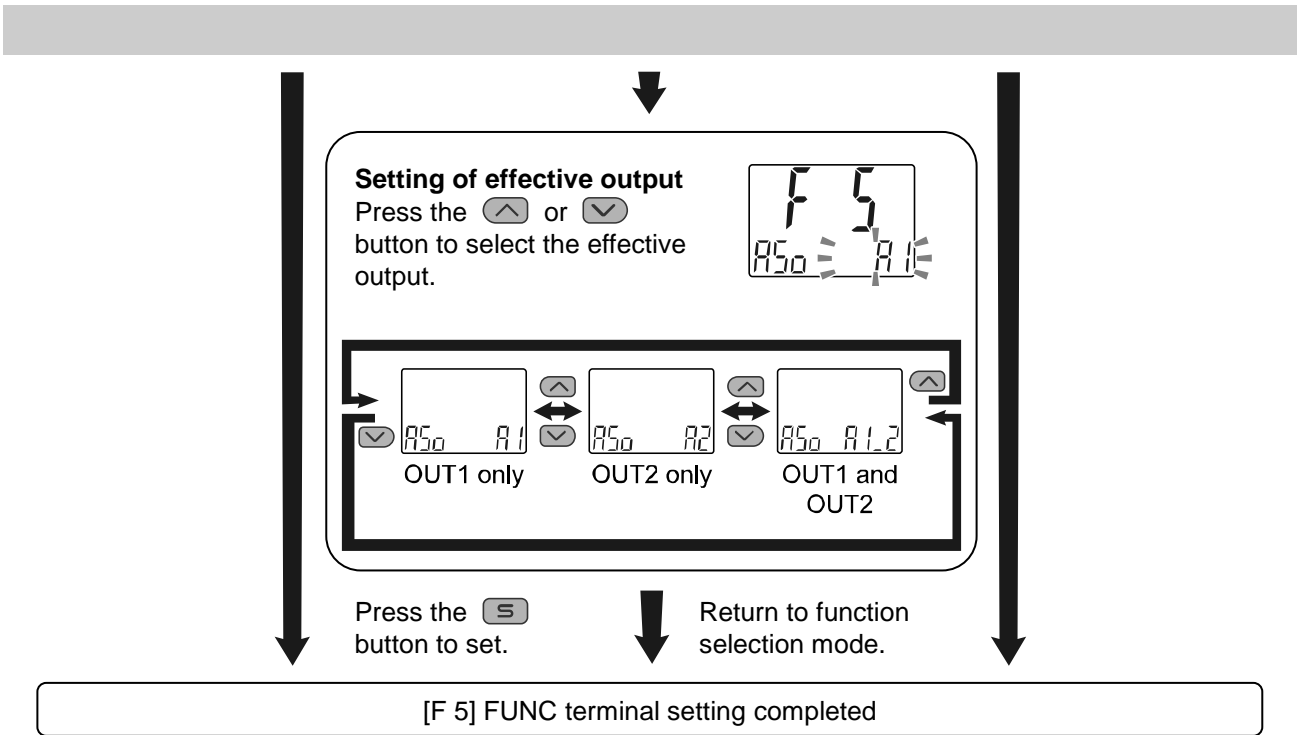

Conditions and explanations for auto-shift function

- Maintain a constant pressure for 5 ms or longer from the end of the auto-shift input signal.
- The sub screen displays "ASin ooo" for approximately 1 second during auto-shift input, and the pressure value is stored as the corrective value "C_5".
- With the corrected value stored, the set value is compensated.
- When the set value is corrected, the switch output will operate in accordance with the delay time, within 5 ms after the auto-shift input.
- If the measurement pressure during the auto-shift input operation exceeds the set pressure range, the corrected value will not be stored, but "ASin o.r" will be displayed on the sub screen for approximately 1 second.
- If the measurement value during auto-shift input is within the set pressure range, and the set value corrected by auto-shift (including hysteresis) exceeds the set pressure range, the set value will be corrected to the upper or lower value (whichever is closer).
(The correction is performed when the auto-shift input is applied at the pressure beyond the set pressure range. If the auto-shift input is applied again at the pressure within the set pressure range, the correction is released and the product operates according to the set value).
- The corrected value memorized on "C_5" can be displayed on the sub screen in measurement mode.
(Refer to "Sub display" on page 43.)
- The corrected value [C_5] after auto-shift input will disappear when the power is turned off, and will reset to zero (initial value) when the power is returned.

Using the auto-shift input, the acceptable set range is as follows:



Range	Set pressure range	Acceptable set range
Compound pressure	-105.0 to 105.0 kPa	-210 to 210.0 kPa
Positive pressure	-0.105 to 1.050 MPa	-1.155 to 1.155 MPa
Vacuum pressure	10.0 to -105.0 kPa	-115.0 to 115.0 kPa

■[F 6] Fine adjustment of display value

This function is to manually perform a fine adjustment of the displayed pressure value.
Pressure can be adjusted in the following range of $\pm 5\%$ R.D.

<Operation>

Press the  or  button in function selection mode to display [F 6].

Press the  button.  Move on to fine adjustment of display value.

Fine adjustment of display value

Press the  or  button to change adjustment rate.

When adjustment rate is changed, the pressure value after the adjustment will be displayed on the main screen.

Pressure after adjustment



Adjustment rate

Press the  button to set.  Return to function selection mode.

[F 6] Fine adjustment of display value completed

■[F10] Sub display setting

Change the display style of the sub display.

<Operation>

Press the or button in function selection mode to display [F10].

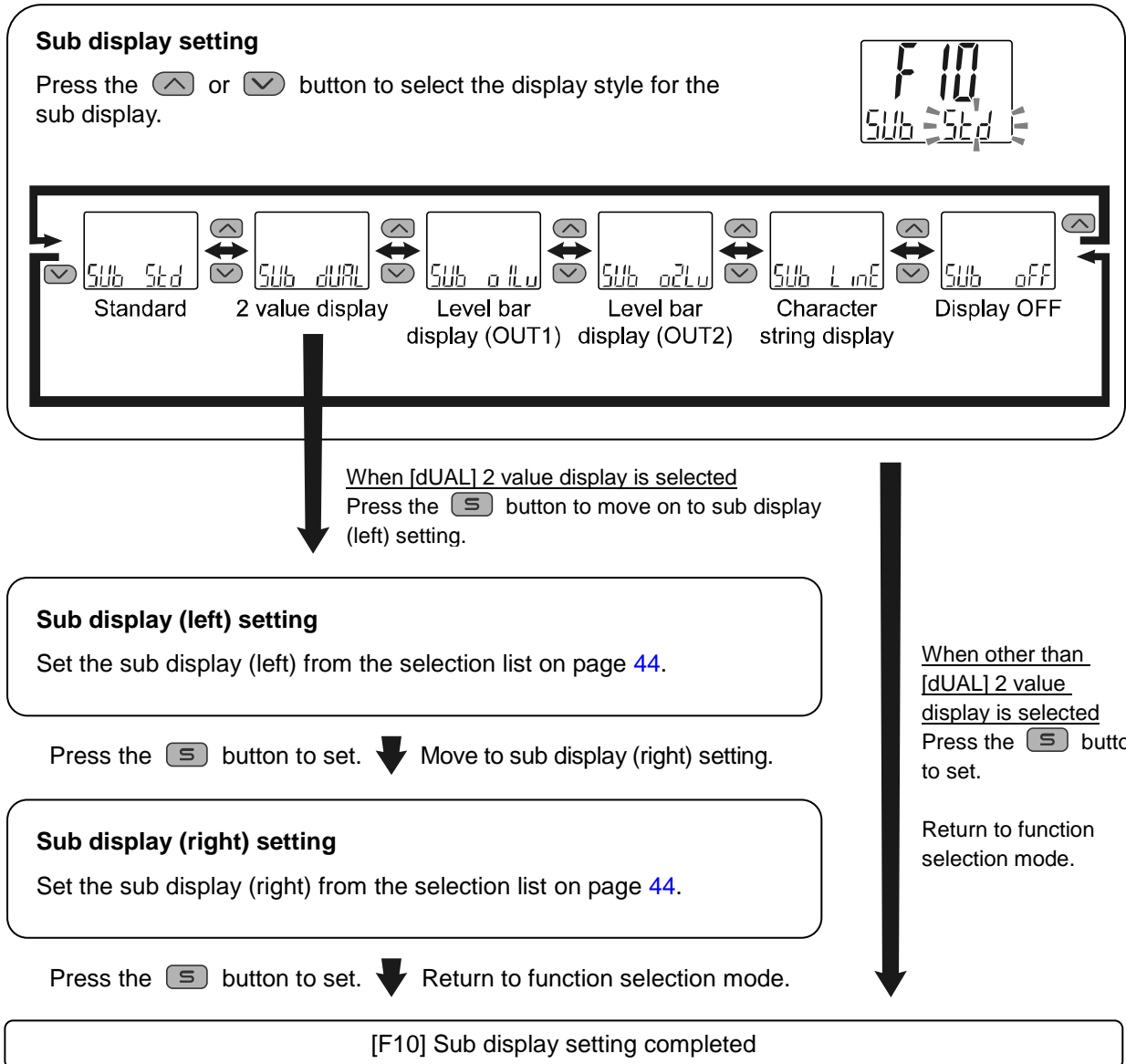

Press the button. Move on to sub display setting.



<Sub display>

•Standard

The Standard display function displays the items and values on the sub display.

The displayed item varies depending on the setting of the output mode. Select the displayed items by pressing the  or  button in measurement mode.

(Hysteresis mode, error output, switch output off)

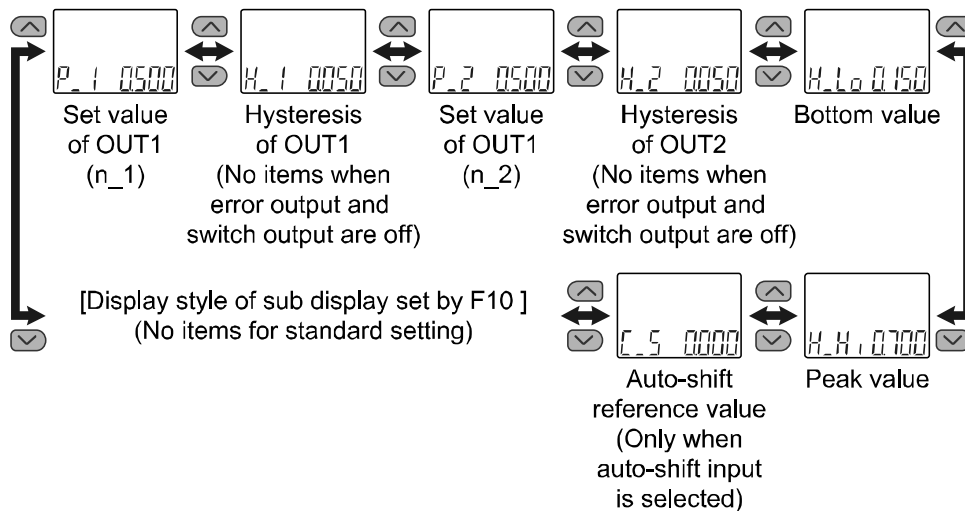

(Window comparator mode)

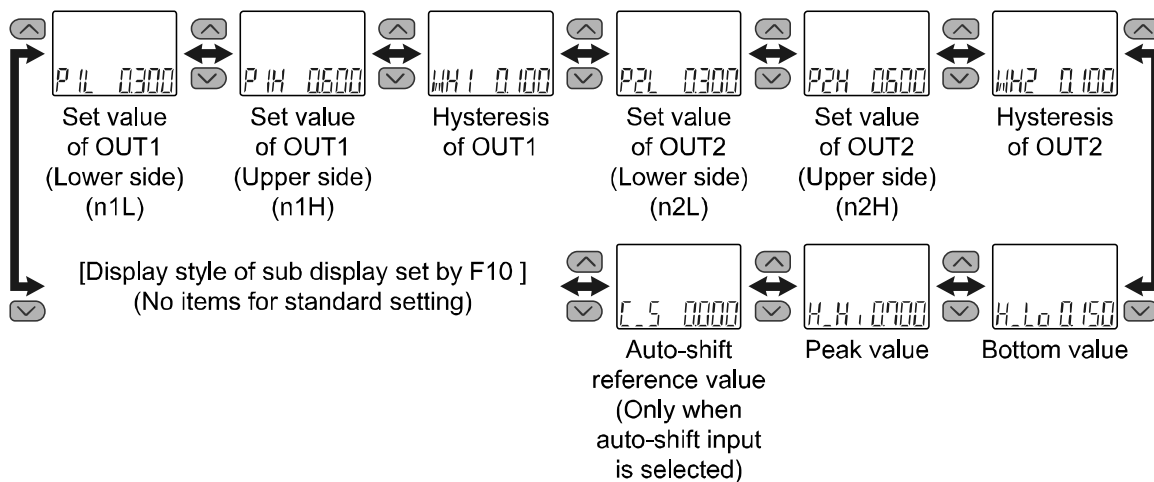

•2 value display

The 2 value display function displays the items listed below on the right and left side of the sub display.

List of items for selection



Item	Details	Sub display		Remarks
		Left side	Right side	
P_1 (n_1)	Set value for OUT1 hysteresis mode	○	○	When hysteresis mode is selected
H_1	OUT1 hysteresis mode	○	○	When hysteresis mode is selected
P_HL (n_HL)	OUT1 Window comparator mode set value (Lower side)	○	○	When window comparator mode is selected
P_HH (n_HH)	OUT1 Window comparator mode set value (Upper side)	○	○	When window comparator mode is selected
WH1	OUT1 window comparator mode	○	○	When window comparator mode is selected
P_2 (n_2)	Set value for OUT2 hysteresis mode	○	○	When hysteresis mode is selected
H_2	OUT2 hysteresis mode	○	○	When hysteresis mode is selected
P2L (n2L)	OUT2 Window comparator mode set value (Lower side)	○	○	When window comparator mode is selected
P2H (n2H)	OUT2 Window comparator mode set value (Upper side)	○	○	When window comparator mode is selected
WH2	OUT2 window comparator mode	○	○	When window comparator mode is selected
H_H1	Pressure peak value	○	x	
H_Lo	Pressure bottom value	x	○	
C_5	Auto-shift reference value	○	○	When auto-shift input is selected
Unit	Pressure display unit	○	○	
RRnG	Rated pressure range	○	○	
Md1	OUT1 output mode/output style	○	x	
Md2	OUT2 output mode/output style	x	○	
LinE	String of random characters	○	○	
off	Display OFF	○	○	

Table showing the rated pressure range when RAnG is selected.

Pressure range	Rated pressure	Characters displayed on the sub display
Vacuum pressure	-101.3 kPa	VACU
Compound pressure	100 kPa	Comp
Positive pressure	1 MPa	Posi

Table showing the output mode and output form when Md1 and Md2 are selected.

Output mode	Output style	Display style
Hysteresis mode	Normal output	--┐
	Reversed output	└--
Window comparator mode	Normal output	┐┐
	Reversed output	└└
Error output	Normal/Reversed output	Error
Switch output off	-	off

When using the 2 value display function, 3 step setting is not available for the display.
 (When setting 3 step, select each set value to be displayed by pressing the  or  button.)

When output operation mode is changed after selecting the 2 value display, the selected display items will not be applicable and [- - -] will be displayed. In this case, select items for the 2 value display setting again.

•Level bar display

The Level bar display is a function used to visualize the pressure and the ON area for the switch output on the sub display.

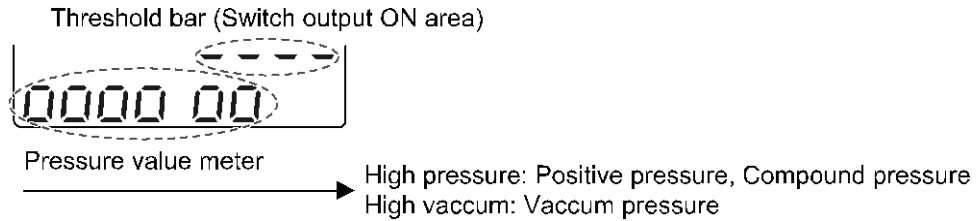

The display style varies depending on the setting of the output mode.

(In hysteresis mode or window comparator mode)

The threshold bar displaying the switch output ON area is displayed according to the table below, using the output mode.

(During error output or when the output is off)

The threshold bar will not be displayed. Only the pressure value meter is displayed.

Output mode	Output style	Threshold bar display style
Hysteresis mode	Normal output	P_1
	Reversed output	n_1
Window comparator mode	Normal output	P1L P1H
	Reversed output	n1L n1H
Error output	Normal/Reversed output	No indication
Switch output off	-	No indication

The Level bar display resolution (pressure for one "O") varies depending on the output mode.

Output mode	Display resolution
Hysteresis mode	1/10 of P_1(n_1), P_2(n_2)
Window comparator mode	1/4 of P1H-P1L(n1H-n1L), P2H-P2L(n2H-n2L)
Error output	Positive pressure, vacuum pressure: Rated maximum pressure - 1/7 of the atmospheric pressure Compound pressure: Rated maximum pressure - 1/4 of the atmospheric pressure
Switch output off	Positive pressure, vacuum pressure: Rated maximum pressure - 1/7 of the atmospheric pressure Compound pressure: Rated maximum pressure - 1/4 of the atmospheric pressure

During an error output or when the output setting is off, the pressure value meter at the atmospheric pressure is displayed according to the table below.

Rated range	Display at atmospheric pressure	
Vacuum pressure		or
Compound pressure		or
Positive pressure		or

•Character string display

The Character string display function will display the specified characters on the sub display (right). Character setting is performed using the function [F82] Input of line name.

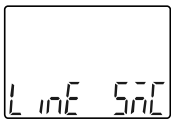



•Display OFF



The Sub display is not displayed.

■[F11] Display resolution setting



This function is to change the pressure display resolution.
The flicker of the display can be reduced.

<Operation>

Press the  or  button in function selection mode to display [F11].

Press the  button.  Move on to display resolution setting.

Display resolution setting

Press the  or  button to select the display resolution.

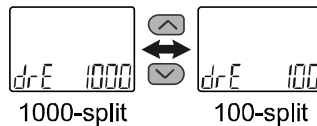

Press the  button to set.  Return to function selection mode.

[F11] Display resolution setting completed

*: It may not be possible to change the resolution depending on the unit of pressure selected.

The units that allow display resolution to be selected are [MPa], [kPa(ZSE20B(F) only)], [kgf/cm²], [bar], [psi] and [inHg]

(The units [kgf/cm²], [bar], [psi] and [inHg] can only be set when using a product with units selection function.)



➡ Page 30 [F 0] Units selection function

■[F80] Power saving mode

Power saving mode can be selected.



When selected and no buttons are pressed for 30 seconds, the pressure switch will shift to power saving mode.

<Operation>

Press the  or  button in function selection mode to display [F80].

Press the  button.  Move on to power saving mode.

Power saving mode

Press the  or  button to select the power saving mode.

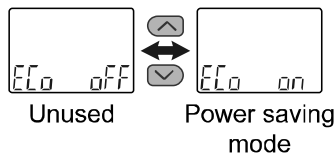

Press the  button to set.  Return to function selection mode.

[F80] Power saving mode completed

In power saving mode, when buttons are pressed the display is normal, but if no buttons are pressed for 30 seconds, it will revert to power saving mode. (Power saving is only enabled in measurement mode)

During power saving mode, [ECo] will flash in the sub display and the operation light is ON (only when the switch is ON).



At switch ON





At switch OFF

■[F81] Security code



The security code can be turned on or off and the security code can be changed when unlocked.

<Operation>

Press the  or  button in function selection mode to display [F81].

Press the  button.  Move on to security code.

Security code

Press the  or  button to select the setting of security code.

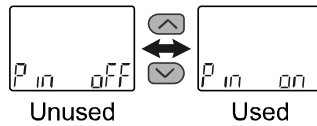

[on] (use) is selected



Press the  button to set.

 Move on to security code checking.

[oFF] (not use) is selected

Press the  button to return to function selection mode.

Security code checking

Press the  or  button to input the security code on the sub display (right).
(The default setting is [000].) *

For instructions on how to enter the security code, refer to "How to input and change the security code" on page 64.

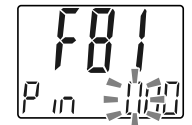

If the security code entered is incorrect, [FAL] will be displayed, and the security code must be entered again.

If the wrong security code is entered 3 times, [nG] is displayed and the device returns to function selection mode.





 Move on to security code changing.



Security code changing

Press the  or  button to input the changed security code on the main display. *
For instructions on how to enter the security code, refer to "How to input and change the security code" on page 64.



After entry, the changed security code will flash by pressing the  button for 1 second.
(At this point, the changing of the security code is not completed)
Return to the change of setting again by pressing the  or  button.



Press the  button for 1 second to set.  Return to function selection mode.

[F81] Security code completed

If the security code function is enabled, it is will be necessary to input a security code to release the key-lock.

*: If a key is not pressed for 30 seconds while entering the security code, function selection mode will return.

■[F82] Input of line name

Function to display the specified character string on the sub display.

To display in the measurement mode, select 2 value display [dUAL] or character string display [LinE] using the setting on [F10] Sub display setting.

<Operation>

Press the or button in function selection mode to display [F82].

Press the button. Move on to input of line name.

Input of line name

Press the or button to input the line name displayed on the sub display (right).

Press the button to make the next digit to the right flash. Input the line name.

(The most significant digit flashes when the button is pressed at the least significant digit.)

The order of displayed characters is A → b → ... → Y → (Z) → 0 → 1 → ... → 9 → symbol → space.

(Characters which can be displayed are different for 1 digit on the left and 3 digits on the right.)

Pressing the and button simultaneously adds/deletes the dot (decimal point).

The set line name flashes by pressing the button for 1 second or longer.

(At this point, the setting of the line name is not complete.)



Press the button to set. Return to function selection mode.

[F82] Input of line name completed

•Characters which can be displayed for each digit are as follows.

(Pattern for 3 digits on the right)

Characters Q, X, Z, /, or * cannot be displayed.

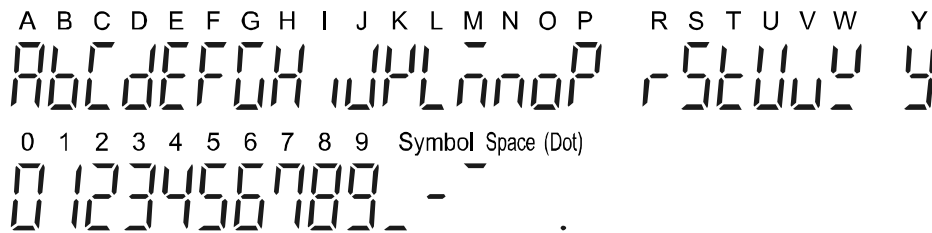

(Pattern for 1 digit on the left)

Characters A to Z can be displayed (the same as the 3 digits on the right).

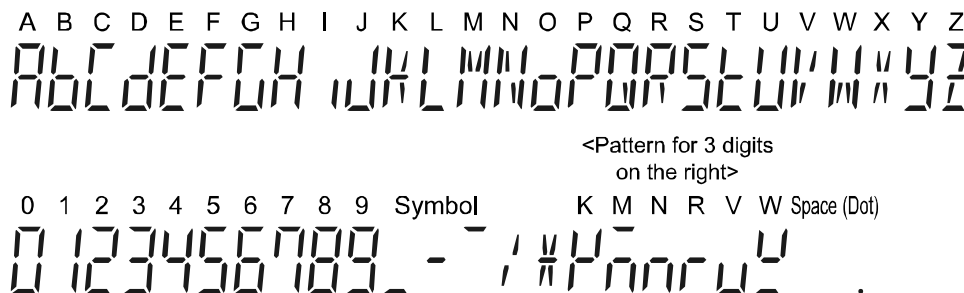

<Pattern for 3 digits on the right>



0 1 2 3 4 5 6 7 8 9 Symbol K M N R V W Space (Dot)

● **Special function setting**

■ **[F90] Setting of all functions**

All functions can be set in turn.

<Operation>

Press the  or  button in function selection mode to display [F90].

Press the  button.  Move on to setting of all functions.

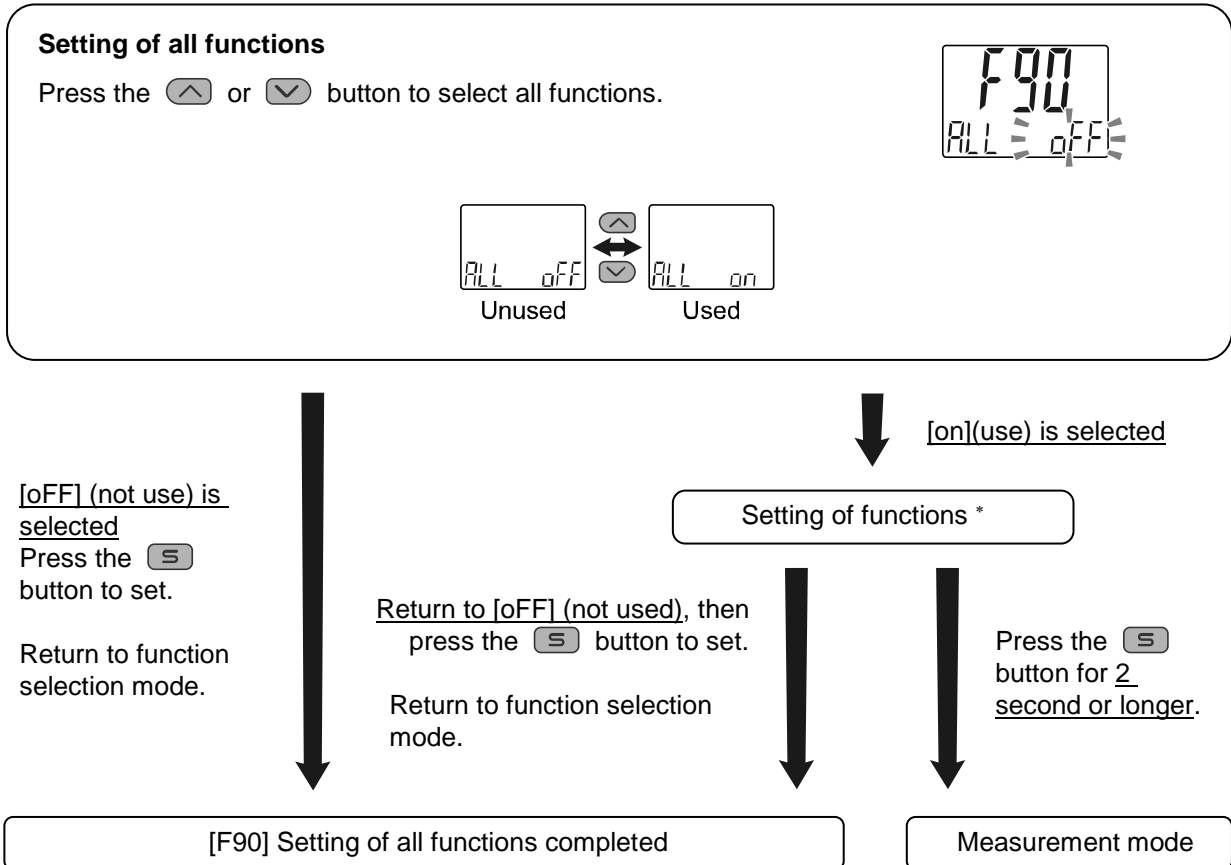

*: Setting of each function

Every time the  button is pressed, the display moves to the next function in order of "Setting of each function" on page 54.

Set by using the  and  buttons.

For details of how to set each function, refer to the relevant setting of function section in this manual.

● Setting of each function

Order	Function
1	Display unit selection
2	Setting of OUT1
3	Setting of OUT2
4	Digital filter setting
5	Auto-preset function
6	FUNC terminal setting
7	Fine adjustment of display value
8	Sub display setting
9	Display resolution setting
10	Power saving mode
11	Security code
12	Input of line name



*: Measurement mode can return from any setting item by pressing the  button for 2 seconds or longer.

*: Function set before returning to the measurement mode is maintained.

■[F96] Input signal check

Checks the input status of the FUNC terminal when the auto-shift input is set.

<Operation>

Press the  or  button in function selection mode to display [F96].

Input signal check

Displays the current input status on the sub screen.

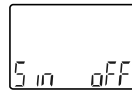

Without input signal

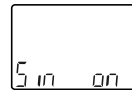

With input signal

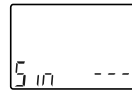

There is no corresponding function

Press the  or  button.

Return to function selection mode.



[F96] Setting of input signal check completed

Press the  button for 2 second or longer.



Measurement mode

■ [F97] Selection of copy function

The set values of pressure and functions (except for corrected value of fine adjustment of display value and line name) can be copied. When the pressure range, output and unit specifications are the same, this function becomes available. The set value can be copied to up to 10 pressure switches simultaneously.

<Connection>

Connect the pressure switches with the power supply turned off.

Connect the FUNC terminals of the master Pressure switch and the slave Pressure switches, and then turn on the power supply.

The master pressure switch is the switch from which the setting is to be copied.

The slave Pressure switch is the switch to which the setting is to be copied.

When the output specifications of the slave side pressure switch are R, S, T or V, they should be set to copy input in accordance with the [F 5] FUNC terminal setting (page 39) beforehand.

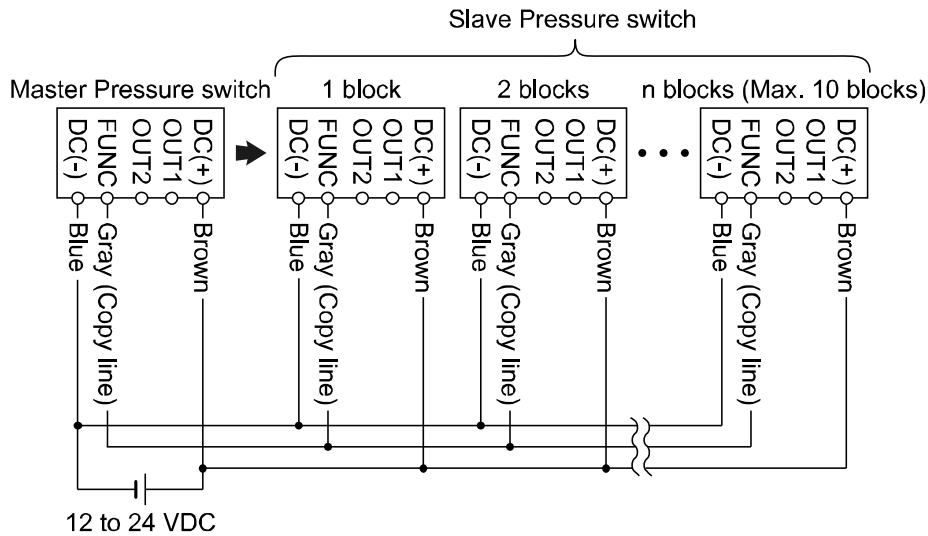

<Operation>

Press the or button of the master Pressure switch in function selection mode to display [F97].

Press the button. Move on to selection of copy function.

Selection of copy function

Press the or button to select copy function.

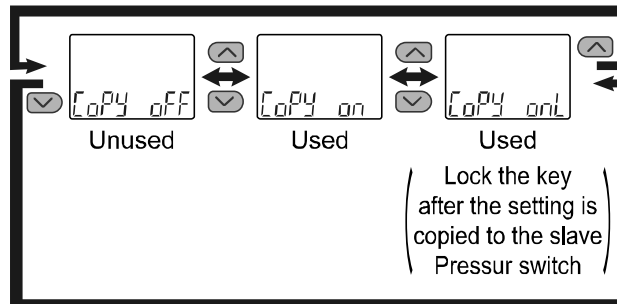

[oFF] (not use) is selected
Press the button to set.

Return to function selection mode.

[on] (use)
[onL] (use) is selected
Press the button to set.

Move to copy ready status.

Copy ready status



Copy is ready

Even though the power supply is turned OFF, the copy ready status will be retained.

Press the button to start copying. ↓

	The master Pressure switch	The slave Pressure switch
Sending/ Receiving	Main display: Red	Main display: Green
Copy completed	Main display: Red	<ul style="list-style-type: none"> •When completed normally Main display: Green •When error occurs Main display: Red

(Master side)
Press the button.

The copy can be made continuously and the copy ready status can be held even if the power supply is turned off.



Copy is ready

(Master side)
Press the and buttons simultaneously for 1 second or longer.

(Slave side)
When completed normally.
Press the button.

To complete the copy function, press the and buttons simultaneously for 1 second or longer.

[F97] Setting of selection of copy function completed

Measurement mode



*: When the slave side pressure switch displays [Er13], it indicates a sending and receiving error of the copy function. Press the and buttons simultaneously for 1 second or longer to return to measurement mode. Then, check the wiring and specifications of the switch and retry the copy function.

*: When copy is conducted so that the analog output is used, set the FUNC terminal setting of the master side pressure switch to Aout, then conduct a copy. The FUNC terminal setting of the slave side pressure switch will be Aout when the copy is complete.

■[F98] Output check



Correct operation of the switch output can be confirmed.
The output can be turned ON/OFF manually.

<Operation>

Press the  or  button in function selection mode to display [F98].

Press the  button.  Move on to output check.

Output check

Press the  or  button to select output check.

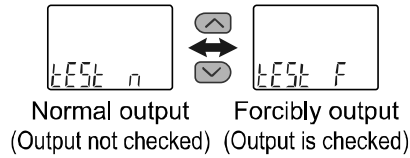

[F] (Forced output) is selected
Press the  button.

 Move on to OUT1 output check.

[n] (Normal output) is selected

Press the  button to set.

Return to function selection mode.

OUT1 output check

Press the  or  button to select OUT1 output check.

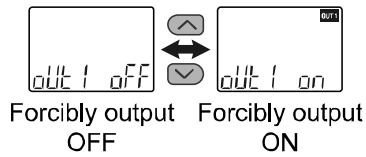



Press the  button.

 Move on to OUT2 output check.



[n] (Normal output) is selected
Press the  button to set.

Return to function selection mode.

OUT2 output check

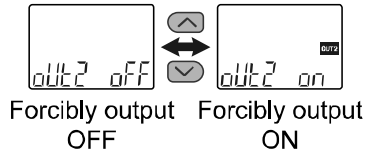
Press the  or  button to select OUT2 output check.



Press the  button to return to [n](normal output), then press the  button to set.

Return to function selection mode.

Press the  button for 2 second or longer.

[F98] Output check completed



Measurement mode

*: Measurement mode can return from any setting item by pressing the  button for 2 seconds or longer.

■[F99] Reset to default settings



If the product settings are uncertain, the default values can be restored.

<Operation>

Press the  or  button in function selection mode to display [F99].

Press the  button.  Move on to reset to default settings.

Reset to default settings

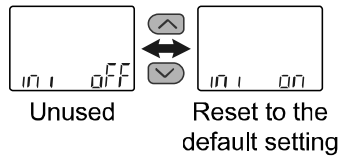

Press the  or  button to select reset to default settings.



[oFF] (not use) is selected
Press the  button to set.

Return to function selection mode.

[on] (reset to default settings) is selected

Press the  and  buttons simultaneously for 5 second or longer.



All settings are returned to the default values. Return to function selection mode.

[F99] Reset to default settings completed

Other Settings

○ Snap shot function

The current pressure value can be stored to the switch output ON/OFF set point.

When the items of sub display (left) below are selected in 3 step setting mode, simple setting mode or function selection mode ([F 1] Setting of OUT1, [F 2] Setting of OUT2), by pressing the  and  buttons simultaneously for 1 second or longer, the value of the sub display (right) shows [- - -], and the values corresponding to the current pressure values are automatically displayed.

Output mode	Configurable items	Sub display (left)	Snap shot function
Hysteresis mode	OUT1, OUT2 set value	$P_{-1} (n_{-1}), P_{-2} (n_{-2})$	○
	Hysteresis	H_{-1}, H_{-2}	○
Window comparator mode	OUT1, OUT2 set value	$P_{1L} (n_{1L}), P_{1H} (n_{1H})$ $P_{2L} (n_{2L}), P_{2H} (n_{2H})$	○
	Hysteresis	WH_1, WH_2	x

• OUT1 set value and OUT2 set value

The value is set to the same value as the display value (current pressure value).

(There is a range which cannot be set to the current pressure depending on the hysteresis. In that case, the value is set to the closest value.)

• Hysteresis

The hysteresis is calculated from the equation below and set.

Normal output: (OUT1(2) set value) - (current pressure value) Reverse output: (current pressure value) - (OUT1(2) set value)



If the calculation result becomes 0 or less, [Err] is displayed on the sub display (right) and the set value is not changed.

Afterwards, it is possible to adjust the value by pressing the  or  button.

○ Peak/bottom value indication

The maximum (minimum) pressure when the power is supplied is detected and updated.



In peak/bottom indication mode, the current pressure is displayed.

Press the  or  button in measurement mode to switch the sub-display (left) to the display shown below.

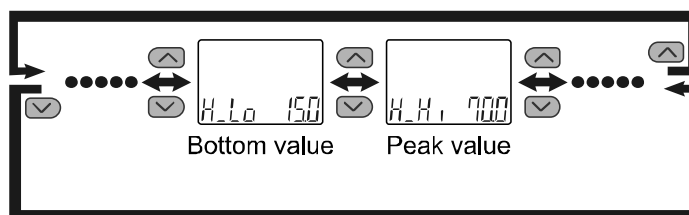
Peak/bottom values are displayed on the sub display (right) at the same time as the current pressure value on the main display.





Peak/bottom values are maintained even if the power supply is cut.

When the  and  buttons are pressed for 1 second or longer simultaneously while the peak/bottom values are displayed, the sub display (right) displays [- - -] and the maximum (minimum) pressure value are cleared.

○ Zero-clear function

The displayed value can be adjusted to zero if the pressure being measured is within $\pm 7\%$ F.S ($\pm 3.5\%$ F.S. for compound pressure) of the zero point set at the time of default settings.

(The zero clear range varies by $\pm 1\%$ F.S. due to variation between individual products.)

In measurement mode, when the  and  buttons are pressed for 1 second or longer simultaneously, the main display shows [- - -], and the reset to zero. The display returns to measurement mode automatically.

○Key-lock function

The key-lock function is used to prevent errors occurring due to unintentional changes of the set values. If the **[S]** button is pressed while the keys are locked, [LoC] is displayed on the sub display (left) for approximately 1 second.

(Each setting and peak/bottom values are displayed with **[^]** and **[v]** buttons. In that case, the sub screen will return after 30 seconds.)

<Operation - Without security code input ->

- (1) Press the **[S]** button for 5 seconds or longer in measurement mode. When [oPE] is displayed on the main display, release the button.

The current setting [LoC] or [UnL] will be displayed on the sub display.

(To release key-lock repeat the above operation.)



- (2) Select the key-locking/un-locking with **[^]** or **[v]** button, and press the **[S]** button to set.

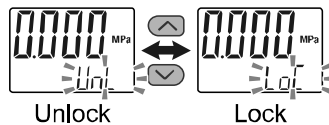

<Operation – With security code input ->

•Locking

- (1) Press the **S** button for 5 seconds or longer in measurement mode. When [oPE] is displayed on the main display, release the button.

The current setting [LoC] or [UnL] will be displayed on the sub display.



- (2) Select the key [LoC] with **▲** or **▼** button, and press the **S** button to set.

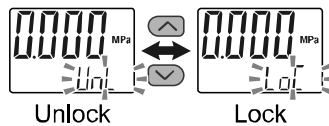

•Unlocking

- (1) Press the **S** button for 5 seconds or longer in measurement mode. When [oPE] is displayed on the main display, release the button.

The current setting [LoC] or [UnL] will be displayed on the sub display.

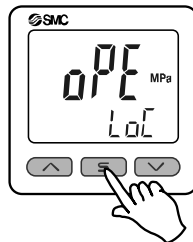

- (2) Select the un-locking [UnL] with **▲** or **▼** button. Setting is recognized by pressing the **S** button, then security code is required.

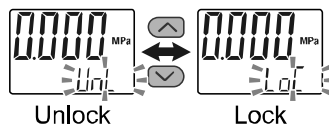

- (3) For instructions on how to enter the security code, refer to "How to input and change the security code" on page 64.

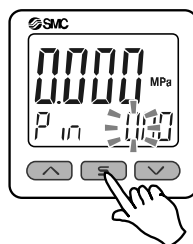



- (4) If inputted security code is correct, the indication of the main display changes to [UnL], and pressing the one of **▲**, **S** or **▼** button releases key-lock and the measurement mode returns.
If the security code entered is incorrect, [FAL] will be displayed, and the security code must be entered again. If the wrong security code is entered 3 times, [LoC] is displayed and the device returns to measurement mode.

•How to input and change the security code

The left most digit starts flashing.

Press the  or  button to select a value.

Press the  button to make the next digit to the right flash.

(If the  button is pressed at the last digit, the first digit will start flashing.)

After the setting is complete, Press and hold the  button for 1 second or longer.

(If an operation is not performed for 30 seconds during input or change of the security code, it will return to measurement mode.)

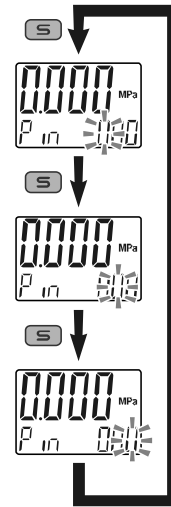

Maintenance

How to reset the product after a power cut or forcible de-energizing

The setting of the product will be retained as it was before a power cut or de-energizing. The output condition is also basically recovered to that before a power cut or de-energizing, but may change depending on the operating environment. Therefore, check the safety of the whole installation before operating the product. If the installation is using accurate control, wait until the product has warmed up (approximately 10 to 15 minutes).

Forgotten the security code

Use the procedure below when the security code has been forgotten.



<Operation>

Press the  button for 5 seconds or longer in measurement mode. When [oPE] is displayed on the main display, release the button.

The current setting [LoC] or [UnL] will be displayed on the sub display.



Press the  and  buttons simultaneously for 5 second or longer.

Press the  and  buttons simultaneously for 5 second or longer.

*: Display is not changed.

(If another operation is performed or no operation is performed for 30 seconds, the display will return to measurement mode.)

Press the  and  buttons simultaneously for 5 second or longer.

The current security code is displayed and the screen will move to security code change mode.

(If an operation is not performed for 30 seconds, the display will return to measurement mode.)





Decide on the security code referring to "How to input and change the security code" on page [64](#).

When input is completed, the selected security code flashes.

After checking the security code is as required, press the  button for 1 second or longer.

Return to measurement mode.

At this time, if the  or  buttons are pressed, any security code changes are lost, and the change of security code must be repeated.

Troubleshooting

○Troubleshooting

Applicable pressure switch: **ZSE20B(F)/ISE20B**

When any failure occurs with this product, the following chart can be used to identify the cause of the failure. If a cause applicable to the troubles cannot be identified and normal operation is recovered by replacement with a new product, this indicates that the product itself was faulty. Problems with the product may be due to the operating environment (installation etc). Please consult SMC.

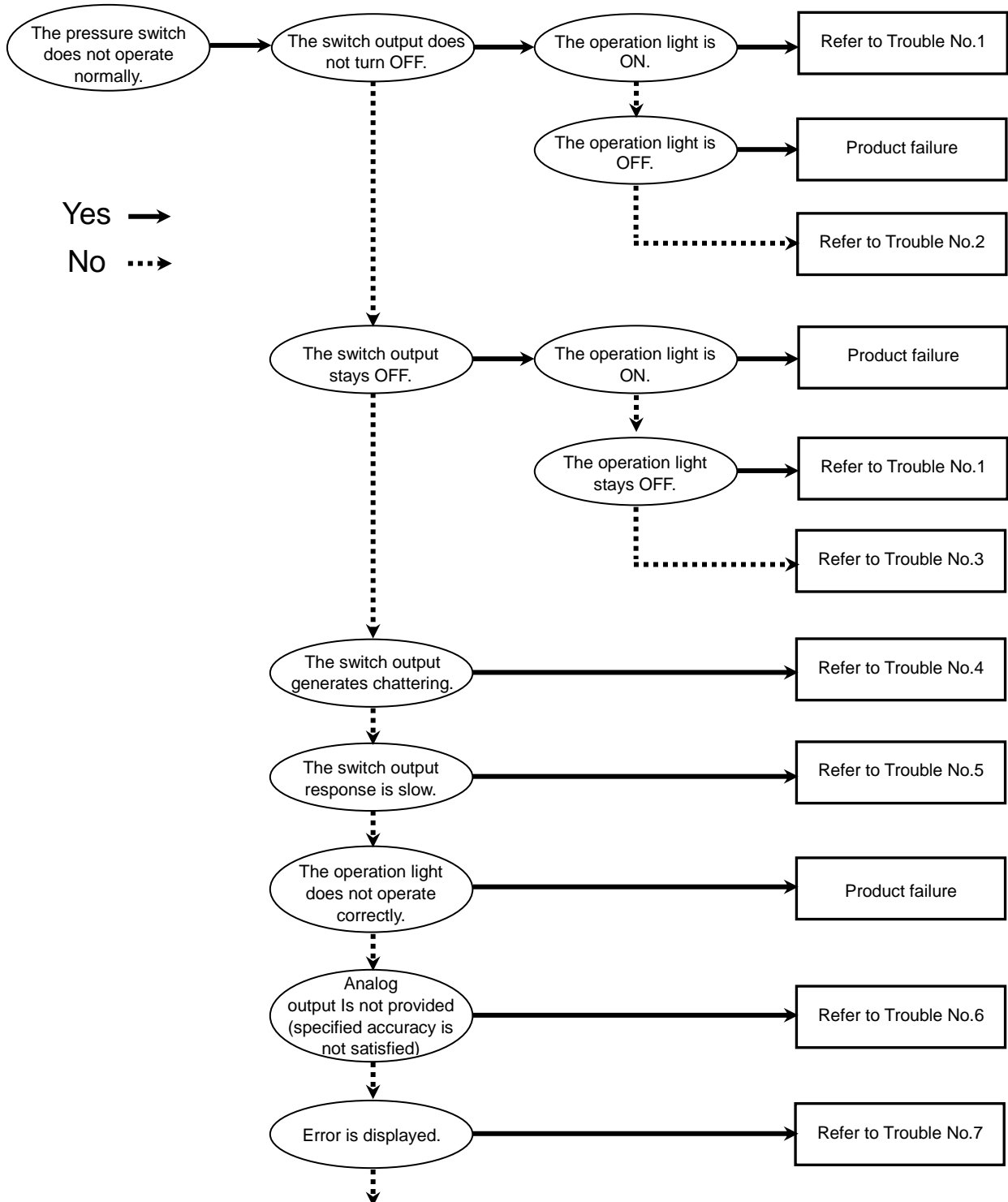

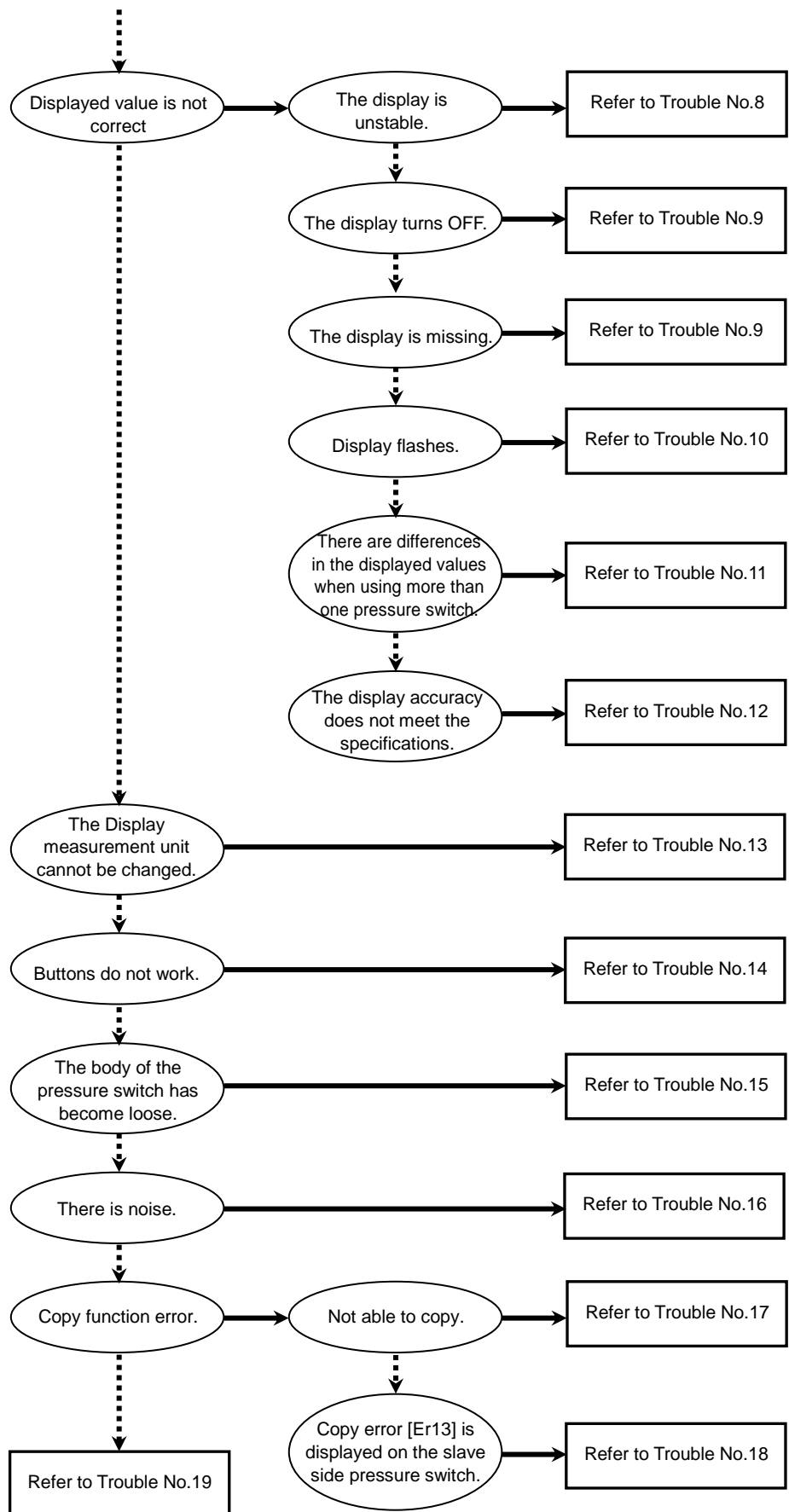

○Troubleshooting list

Problem No.	Problem	Problem possible causes	Investigation method	Countermeasures
1	<ul style="list-style-type: none"> •Output remains ON. Indicator LED remains ON. •Output remains OFF. Indicator LED remains OFF. 	Incorrect pressure setting	(1) Check the set pressure. (2) Check the operation mode, hysteresis and output type. (hysteresis mode/window comparator mode, normal/reversed output)	(1) Reset the pressure setting. (2) Reset the function settings.
		Product failure		Replace the product.
2	Output remains ON. Indicator LED works correctly.	Incorrect wiring	Check the wiring of the output. Check if the load is connected directly to DC(+) or DC(-).	Correct the wiring.
		Product failure		Replace the product.
3	Output remains OFF. Indicator LED works correctly.	Incorrect wiring	Check the wiring of the output. Check if the load is connected directly to DC(+) or DC(-).	Correct the wiring.
		Unsuitable model selection	Check if PNP is used when NPN should have been selected, or the other way around.	Review the selected model (output type).
		Broken lead wire	Check if there is bending stress applied to any parts of the lead wire. (bending radius and tensile force applied)	Correct the wiring conditions. (adjust the tensile force and increase the bending radius.)
		Product failure		Replace the product.
4	Switch output generates chattering.	Incorrect wiring	Check the wiring. Check if the brown and blue wires are connected to DC(+) and DC(-) respectively, and if the output wiring is loose (contact failure).	Correct the wiring.
		Incorrect settings	(1) Check the set pressure. (2) Check that the hysteresis range is not too narrow. (3) Check the delay time setting. Check if the delay time is too short.	(1) Reset the pressure setting. (2) Increase the hysteresis. (3) Reset the function settings.
		Product failure		Replace the product.

Problem No.	Problem	Problem possible causes	Investigation method	Countermeasures
5	Slow switch output response	Incorrect pressure setting	Check the pressure setting. Check that the detected pressure and the set pressure value are not the same or not too close.	Reset the pressure setting. Set the pressure setting value so it is not too close to the detected pressure.
6	Analog output is not provided. (specified accuracy is not satisfied.)	Incorrect wiring	Check that the analog output is connected to a load.	Correct the wiring.
		Non-compliance with the load spec.	(1) Check that the correct load is connected. (2) Check that the impedance of the input equipment (A/D transformer) is suitable.	Connect a suitable load.
		Insufficient warm-up time	Check if the product satisfies the specified accuracy after 10 minutes warm up time.	After energizing, the display and output can drift. For detecting fine pressures, warm up the product for 10 to 15 minutes.
		Product failure		Replace the product.

Problem No.	Problem	Problem possible causes	Investigation method	Countermeasures
7	<ul style="list-style-type: none"> •An over current error (Er1, Er2) is displayed. •System error (Er0, Er4, Er6, Er7, Er8 or Er9) is displayed. •Copy error (Er13) is displayed. •The display shows "HHH". •The display shows "LLL". •Residual pressure error (Er3) is displayed. 	Over current to the output (Er1 and 2)	<ol style="list-style-type: none"> (1) Check that the switch output load current is not more than 80 mA. (2) Check that the connected load satisfies the specifications, and check the load for short circuits. (3) Check that any relay is connected with a surge voltage suppressor. (4) Check if the wiring is not in the same route as (or bundled together with) a high voltage cable or power cable. 	<ol style="list-style-type: none"> (1), (2) Connect the load as specified. (3) Use a relay with a surge voltage suppressor or take measures to prevent noise. (4) Separate the wiring route from any high voltage cable or power cable.
		Incorrect operation of the internal data of the Pressure switch (Er0, Er4, Er6, Er7, Er8, Er9)	<ol style="list-style-type: none"> (1) Check that there is no noise interference such as static electricity, and check for noise sources. (2) Check that the power supply voltage is within the range 12 to 24 VDC $\pm 10\%$. 	<ol style="list-style-type: none"> (1) Remove the noise and the noise source (or take measures to prevent noise interference), and reset the product or turn off the power supply. Then, supply the power again. (2) Supply a correct voltage of 12 to 24 VDC $\pm 10\%$.
		Copy function has been operated incorrectly (Er13)	Refer to Trouble No.18.	
		Applied pressure is above the upper limit (HHH)	<ol style="list-style-type: none"> (1) Check that the pressure is not above the upper limit of the set pressure range. (2) Check that foreign matter has not entered the piping. 	<ol style="list-style-type: none"> (1) Adjust the pressure to within the set pressure range. (2) Take measures to prevent foreign matter from entering the piping.
		Applied pressure is below the lower limit (LLL)	<ol style="list-style-type: none"> (1) Check that the pressure is not below the lower limit of the set pressure range. (2) Check that foreign matter has not entered the piping. 	<ol style="list-style-type: none"> (1) Adjust the pressure to within the set pressure range. (2) Take measures to prevent foreign matter from entering the piping.
		Pressure is not atmospheric pressure at zero-clear operation (Er3)	Check that during the zero clear operation, pressure above $\pm 7\%$ F.S. ($\pm 3.5\%$ F.S. for compound pressure) was not applied.	Return the applied pressure to atmospheric pressure, and retry the zero clear operation.
		Product failure		Replace the product.









Problem No.	Problem	Problem possible causes	Investigation method	Countermeasures
8	Displayed value fluctuates.	Incorrect power supply	Check that the power supply voltage is within the range 12 to 24 VDC $\pm 10\%$.	Supply the correct voltage of 12 to 24 VDC $\pm 10\%$.
		Incorrect wiring	Check the wiring to the power supply. Check that the brown and blue wires are connected to DC(+) and DC(-) respectively and that the output wiring is not loose (contact failure).	Correct the wiring.
		Factory pressure change	Check if the factory pressure has changed.	If the fluctuation is not acceptable, the product display resolution can be changed. Digital filter setting also needs to be improved.
9	<ul style="list-style-type: none"> •Display turns OFF. •Part of the display is missing. 	Incorrect power supply	Check that the power supply voltage is within the range 12 to 24 VDC $\pm 10\%$.	Supply the correct voltage of 12 to 24 VDC $\pm 10\%$.
		Incorrect wiring	Check the power supply wiring. Check that the brown and blue wires are connected to DC(+) and DC(-) respectively and that the output wiring is not loose (contact failure).	Correct the wiring.
		Power saving mode	Check if the power saving mode is selected.	Reset the function settings.
		Product failure		Replace the product.
10	Display is flashing.	Wiring failure	(1) Check the power supply wiring. (2) Check if there is bending stress applied to any parts of the lead wire.	(1) Correct the wiring (2) Correct the wiring conditions (reduce the tensile force and increase the bending radius).
11	Pressure display difference when using 2 or more Pressure switches.	Dispersion within the display accuracy range	Check if the dispersion is within the display accuracy range.	Use the fine adjustment mode to adjust the display if the dispersion is within the display accuracy range.
		Product failure		Replace the product.

Problem No.	Problem	Problem possible causes	Investigation method	Countermeasures
12	The pressure display accuracy does not satisfy the specifications.	Foreign matter	Check if any foreign matter has entered the piping port.	Install a 5 μm filter to prevent foreign matter from entering the piping port. Also, clean the filter regularly to prevent drainage deposits.
		Air or fluid leakage	Check if air or fluid are leaking from the piping.	Rework the piping. If an excessive tightening torque is applied, the mounting bracket, screws or the product may be damaged.
		Insufficient warm-up time	Check if the product satisfies the specified accuracy after 10 minutes warm up time.	After energizing, the display and output can drift. For detecting fine pressures, warm up the product for 10 to 15 minutes.
		Product failure		Replace the product.
13	The display units cannot be changed.	Improper model selection (selection of model "without units selection function")	Check that the product No. printed on the product is equipped with unit switching function.	Unit selection function is not available for models which are fixed to SI units. (kPa↔MPa can be selected) *: The units selection function is not available in Japan due to a new measurement law. *: It is fixed to the SI unit "kPa", "MPa".
		Product failure		Replace the product.
14	The buttons cannot be operated.	Key lock mode	Check if the key lock mode is turned on.	Turn off the key lock mode.
		Product failure		Replace the product.
15	The product is loose.	Incorrect installation	Check that the panel mount adapter and the product are correctly assembled.	Mount the product on the panel correctly.
		Product failure		Replace the product.
16	The product is noisy.	Air or fluid leakage	Check if air or fluid are leaking from the piping.	Rework the piping. If an excessive tightening torque is applied, the mounting bracket, screws or the product may be damaged.
		Product failure		Replace the product.
17	<ul style="list-style-type: none"> •Copy function error •Unable to copy 	Incorrect wiring	(1) Check the wiring connection at the FUNC terminal. (2) Check the power supply wiring.	Correct the wiring.
		Product failure		Replace the product.

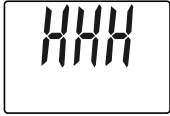
Problem No.	Problem	Problem possible causes	Investigation method	Countermeasures
18	Copy error [Er13] is displayed on the slave side pressure switch.	Incorrect wiring	(1) Check the wiring connection at the FUNC terminal. Check the power supply wiring. (2) Check the lead wire lengths.	(1) Correct the wiring. (2) The maximum transmitting distance of the copy function is 4 m. Shorten the lead wire to 4 m or less.
		Improper model selected	The model number of the master Pressure switch and the slave Pressure switch are different from each other.	Check the model numbers. Copying is available when the pressure range, output specification and units specification are identical.
		Too many pressure switches connected	Check the number of connected slave Pressure switches.	The number of connected products for which copying is possible is up to 10 pcs. Reduce the number to 10 pcs. or less.
		Product failure		Replace the product.
19	The operation is unstable. (chattering)	Effect of line pressure fluctuation because hysteresis is too narrow or delay time of the switch is too short	(1) Check the set pressure values (hysteresis) (2) Check the delay time.	(1) Check the pressure setting. (2) Reset the function settings.
		Incorrect wiring or broken lead wire	(1) Check the power supply wiring. (2) Check if there is bending stress applied to any parts of the lead wire.	(1) Correct the wiring (2) Correct the wiring conditions (reduce the tensile force and increase the bending radius).
		Product failure		Replace the product.

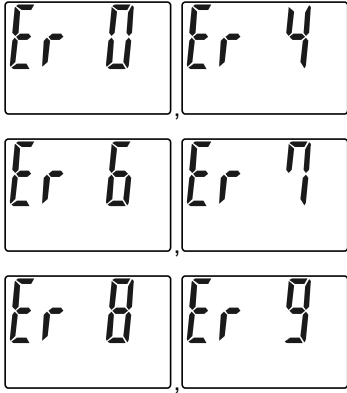
○Error indication function

This function is to display error location and content when a problem or error has occurred.

Error	Error displayed	Description	Measures
Over current error		The switch output load current is 80 mA or more.	Turn the power off and remove the cause of the over current. Then supply the power again.
Residual pressure error		During zero clear operation, pressure greater than $\pm 7\%$ F.S. ($\pm 3.5\%$ F.S. for compound pressure) is present. Note that the mode is returned to measurement mode automatically 1 second later. The zero clear range varies by $\pm 1\%$ F.S. due to variation between individual products.	Release the applied pressure to atmospheric pressure, and retry the zero clear operation.
Pressurizing error		Pressure exceeding the upper limit of the set pressure range is applied.	Reset applied pressure to a level within the set pressure range.
		Pressure exceeding the lower limit of the set pressure range is applied.	
System error		Displayed if an internal data error has occurred.	Turn the power off and on again. If the failure cannot be solved, contact SMC.
Copy error		Copy function is operated incorrectly.	Press the  and  buttons simultaneously for <u>1 second or more</u> to clear the error. Then check the wiring and model before copying again.

If the error cannot be reset after the above measures are taken, or errors other than above are displayed, please contact SMC.

Specification

■ Specifications

Product No.		ZSE20B (Vacuum pressure)	ZSE20BF (Compound pressure)	ISE20B (Positive pressure)	
Applicable fluid		Air, non-corrosive gas and non-flammable gas			
Pressure spec.	Rated pressure range	0.0 to -101.0 kPa	-100.0 to 100.0 kPa	-0.100 to 1.000 MPa	
	Display/Set pressure range	10.0 to -105.0 kPa	-105.0 to 105.0 kPa	-0.105 to 1.050 MPa	
	Display/Min. setting unit	0.1 kPa		0.001 MPa	
	Proof pressure	500 kPa		1.5 MPa	
Power supply spec.	Power supply voltage	12 to 24 VDC±10%, ripple max. 10% (p-p)			
	Current consumption	35 mA or less			
	Protection	Polarity protection			
Accuracy	Display accuracy	±2%F.S. ±1 digit (at ambient temperature 25±3 °C)			
	Repeatability	±0.2%F.S. ±1 digit			
	Analog output accuracy	±2.5%F.S. (at ambient temperature 25±3 °C)			
	Analog output linearity	±1%F.S.			
	Temperature characteristics	±2%F.S. (25 °C standard)			
Switch output	Output type	NPN or PNP open collector 2 outputs			
	Output mode	Hysteresis mode, window comparator mode, error output, switch output off			
	Switch operation	Normal output, reversed output			
	Maximum load current	80 mA			
	Maximum applied voltage (NPN output)	28 V			
	Internal voltage drop (Residual voltage)	1 V or less (Load current 80 mA)			
	Delay time *1	1.5 ms or less (delay time available for anti-chattering function: 20,100,500,1000,2000 or 5000 ms)			
	Hysteresis	Hysteresis mode	Variable from 0 *2		
		Window comparator mode			
	Short circuit protection		Provided		
Analog output	Voltage output	Output type	Voltage output: 1 to 5 V	Voltage output: 0.6 to 5 V	
		Output impedance	Approx. 1 kΩ		
	Current output	Output type	Current output: 4 to 20 mA	Current output: 2.4 to 20 mA	
		Load impedance	Max. lead impedance: 300Ω (at power supply voltage of 12 VDC) 600Ω (at power supply voltage of 24 VDC) Min. lead impedance: 50 Ω		
Auto-shift input	Input type	Non-voltage input : 0.4 V or less			
	Input mode	Select from auto-shift, auto-shift zero			
	Input time	5 ms or more			

Product No.		ZSE20B (Vacuum pressure)	ZSE20BF (Compound pressure)	ISE20B (Positive pressure)
Display	Unit *3	MPa, kPa, kgf/cm ² , bar, psi, InHg, mmHg		MPa, kPa, kgf/cm ² , bar, psi
	Display type	LCD		
	Number of displays	3-screen display (Main display, sub display x 2)		
	Display color	1) Main display: Red/Green 2) Sub display: Orange		
	Number of display digits	Main display: 4 digits (7-segments) Sub display: 4 digits (Upper 1 digit 11-segments, 7-segments for other)		
	Operation light	LED is ON when switch output is ON (OUT1, OUT2: Orange)		
Digital filter *4		0, 10, 50, 100, 500, 1000, 5000 ms		
Environment	Enclosure	IP65		
	Withstand voltage	1000 VAC for 1 minute between terminals and housing		
	Insulation resistance	50 MΩ or more between terminals and housing (with 500 VDC megger)		
	Ambient temperature range	Operation: -5 to 50 °C, Storage: -10 to 60 °C (No condensation or freezing)		
	Operating humidity range	Operation, Storage: 35 to 85%RH (No condensation)		
Standard		UL/CSA(E216656), CE, RoHS		
Length of lead wire with connector		2 m		

*1: Value without digital filter (at 0 ms).

*2: If the applied pressure fluctuates around the set value, the hysteresis must be set to a value more than the amount of fluctuation or chattering will occur.

*3: This setting is only available for models with the units selection function. Only MPa or kPa is available for models without this function.

*4: The response time indicates when the set value is 90% in relation to the step input.

*5: Any products with tiny scratches, smears, or variations in the display color or brightness, which does not affect the performance of the product, are verified as conforming products.

○Piping/weight specifications

Product No.		M5	01	N01
Port size		M5 x 0.8	R1/8	NPT1/8
Materials in fluid contact part	Pressure-sensing part	Silicon		
	Piping port (Common)	PBT, CB156, heat resistant PPS, O-ring: HNBR		
	Piping port	-	C3604 (Electroless nickel plating), SUS304, NBR	
Weight	Body	24 g	34 g	36 g
	Lead wire with connector	+39 g		

○Cable specifications

Conductor area		0.15 mm ² (AWG26)
Insulator	Outside diameter	1.0 mm
	Color	Brown, Blue, Black, White, Gray (5 core)
Sheath	Finished outside diameter	φ3.5

■ Dimensions

M5 type

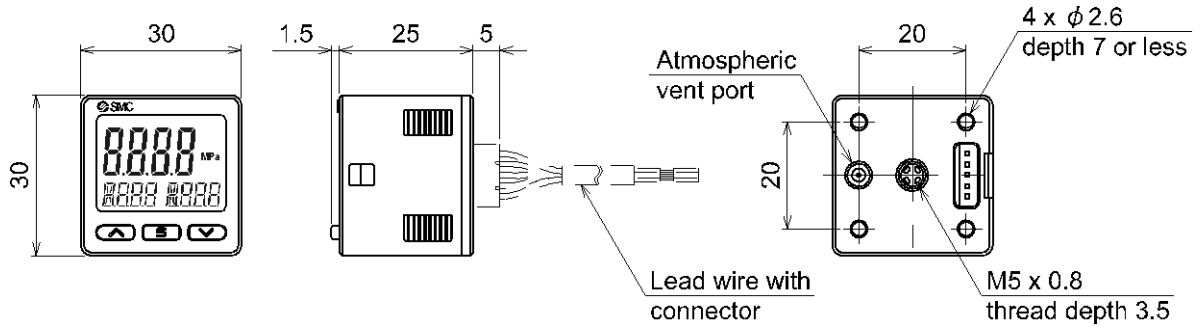

01/N01 type

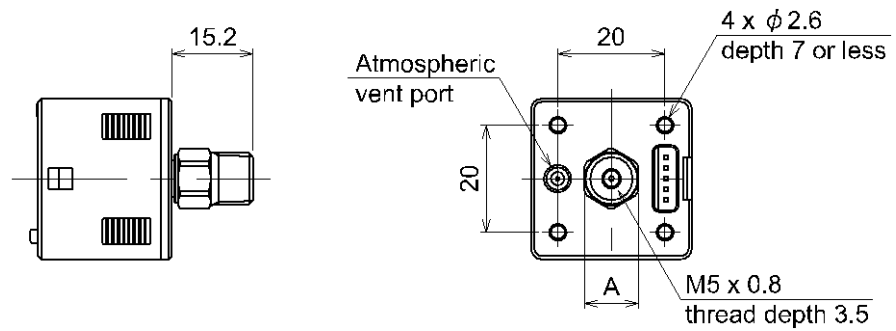

Piping specifications	Port size	A
01	R1/8	Width across flats 10
N01	NPT1/8	Width across flats 12

○Bracket mounting dimensions

●Bracket A

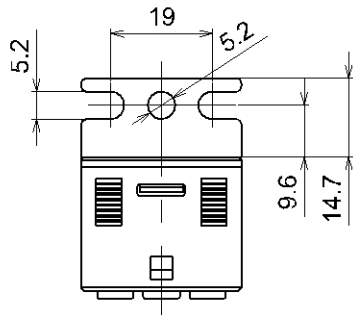
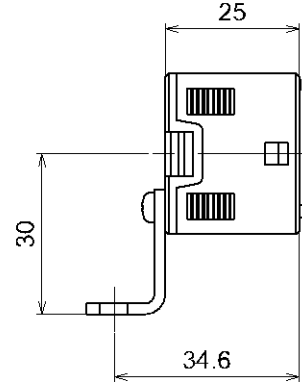
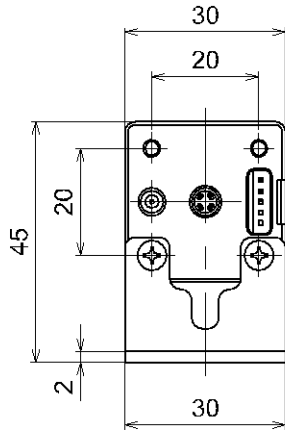

●Bracket B

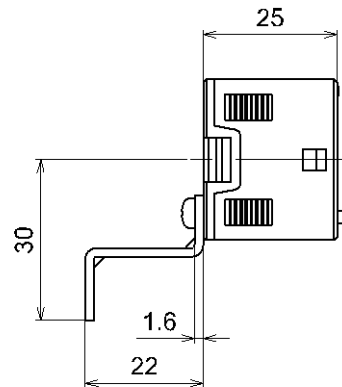
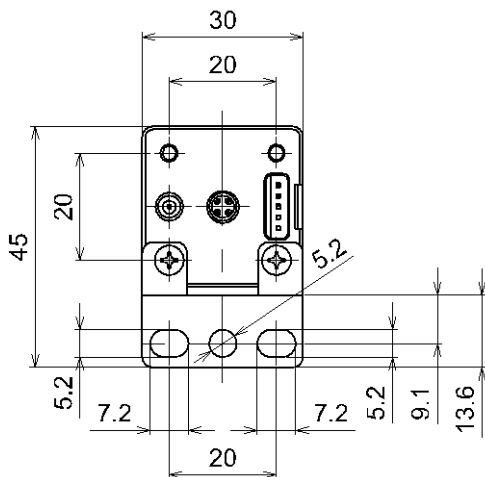
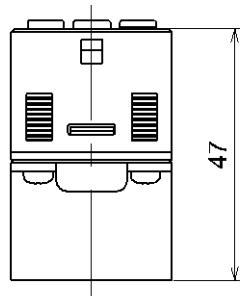

○Mounting dimensions of panel mount adapter

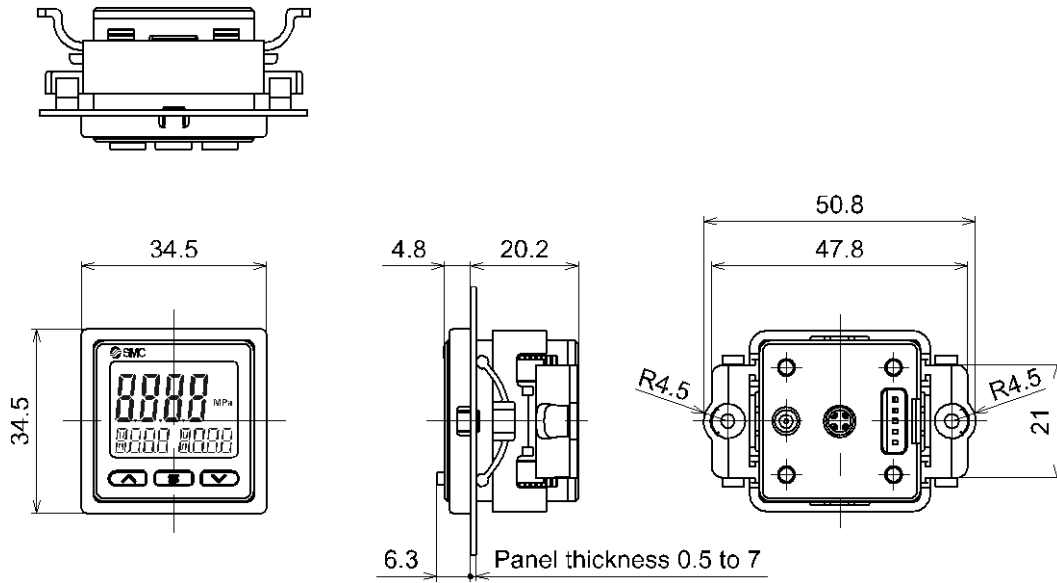

○Mounting dimension of panel mount adapter + Front protective cover

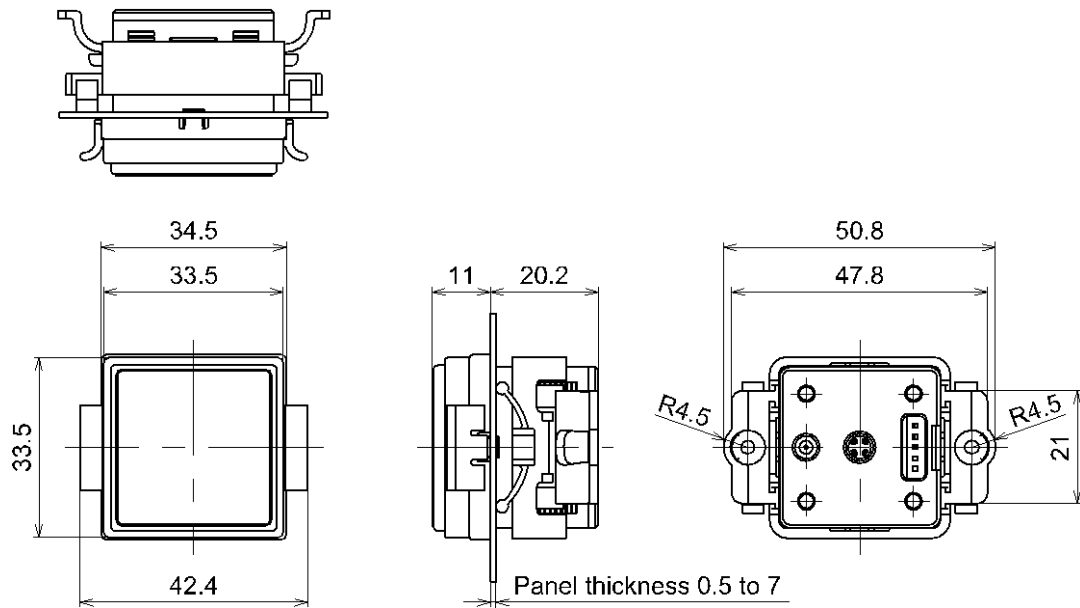

○ Panel cutout dimensions

Mount individually

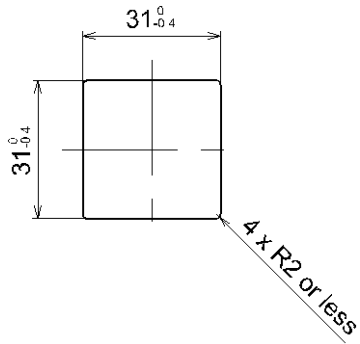

More than 2 pcs. (n pcs.) Close mounting

<Horizontal>

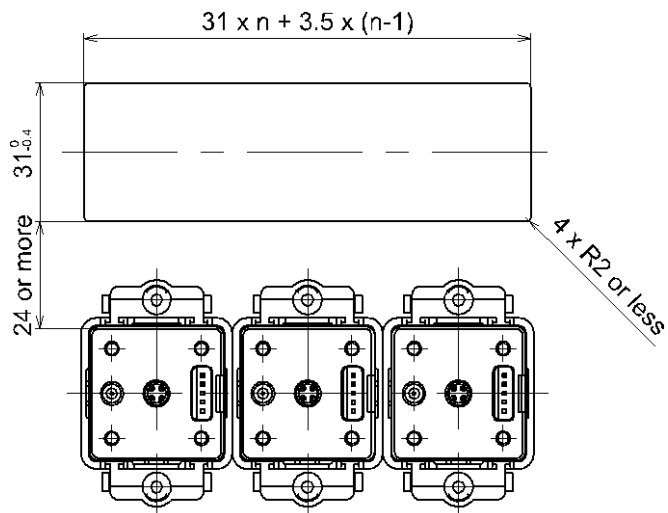

<Vertical>

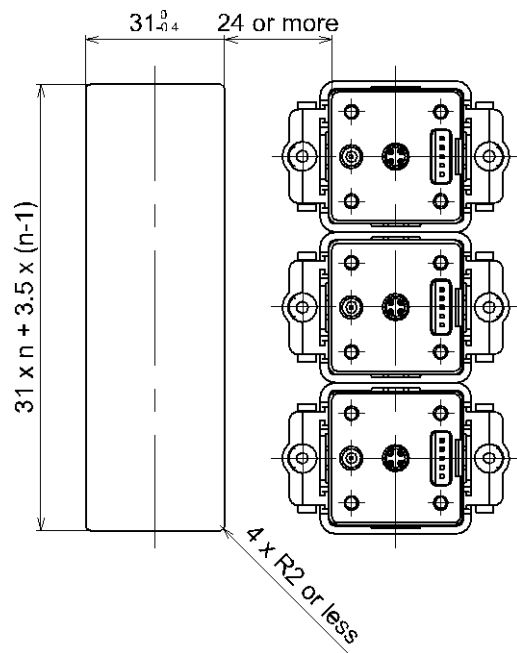

Revision history
A: Contents revised in several places. [July 2018]

SMC Corporation

4-14-1, Sotokanda, Chiyoda-ku, Tokyo 101-0021 JAPAN

Tel: + 81 3 5207 8249 Fax: +81 3 5298 5362

URL <http://www.smcworld.com>

Note: Specifications are subject to change without prior notice and any obligation on the part of the manufacturer.
© 2017-2018 SMC Corporation All Rights Reserved.

