



Operation Manual

PRODUCT NAME

Digital Flow Switch
(Integrated display type)
( IO-Link compatible)

MODEL / Series / Product Number

PF3W7##

SMC Corporation

Table of Contents

Safety Instructions	2
Model Indication and How to Order	11
Summary of Product parts	14
Definition and terminology	16
Mounting and Installation	18
Installation	19
Piping	21
Wiring	24
Flow Setting	26
Simple Setting Mode	29
Function Setting	30
Default settings	31
F0 Display units and switch output specifications	33
F1 Setting of OUT1	34
F2 Setting of OUT2	42
F3 Digital filter setting	49
F10 Sub screen setting	50
F30 Accumulated flow value hold setting	56
F80 Display OFF mode setting	57
F81 Setting of security code	58
F90 Setting of all functions	60
F98 Output check	61
F99 Reset to default settings	64
Other Settings	65
Maintenance	69
IO-Link Specifications	69
Outline of IO-Link functions	69
Communication specifications	69
Process data	70
IO-Link parameter setting	74
Troubleshooting	85
Specifications	90
Characteristics graph	94
Dimensions	100



Safety Instructions

These safety instructions are intended to prevent hazardous situations and/or equipment damage. These instructions indicate the level of potential hazard with the labels of "Caution", "Warning" or "Danger". They are all important notes for safety and must be followed in addition to International Standards (ISO/IEC)*1), and other safety regulations.

*1) ISO 4414: Pneumatic fluid power -- General rules relating to systems.

ISO 4413: Hydraulic fluid power -- General rules relating to systems.

IEC 60204-1: Safety of machinery -- Electrical equipment of machines .(Part 1: General requirements)

ISO 10218: Manipulating industrial robots -Safety.

etc.



Caution

Caution indicates a hazard with a low level of risk which, if not avoided, could result in minor or moderate injury.



Warning

Warning indicates a hazard with a medium level of risk which, if not avoided, could result in death or serious injury.



Danger

Danger indicates a hazard with a high level of risk which, if not avoided, will result in death or serious injury.

Warning

1. The compatibility of the product is the responsibility of the person who designs the equipment or decides its specifications.

Since the product specified here is used under various operating conditions, its compatibility with specific equipment must be decided by the person who designs the equipment or decides its specifications based on necessary analysis and test results.

The expected performance and safety assurance of the equipment will be the responsibility of the person who has determined its compatibility with the product.

This person should also continuously review all specifications of the product referring to its latest catalog information, with a view to giving due consideration to any possibility of equipment failure when configuring the equipment.

2. Only personnel with appropriate training should operate machinery and equipment.

The product specified here may become unsafe if handled incorrectly.

The assembly, operation and maintenance of machines or equipment including our products must be performed by an operator who is appropriately trained and experienced.

3. Do not service or attempt to remove product and machinery/equipment until safety is confirmed.

1. The inspection and maintenance of machinery/equipment should only be performed after measures to prevent falling or runaway of the driven objects have been confirmed.

2. When the product is to be removed, confirm that the safety measures as mentioned above are implemented and the power from any appropriate source is cut, and read and understand the specific product precautions of all relevant products carefully.

3. Before machinery/equipment is restarted, take measures to prevent unexpected operation and malfunction.

4. Contact SMC beforehand and take special consideration of safety measures if the product is to be used in any of the following conditions.

1. Conditions and environments outside of the given specifications, or use outdoors or in a place exposed to direct sunlight.

2. Installation on equipment in conjunction with atomic energy, railways, air navigation, space, shipping, vehicles, military, medical treatment, combustion and recreation, or equipment in contact with food and beverages, emergency stop circuits, clutch and brake circuits in press applications, safety equipment or other applications unsuitable for the standard specifications described in the product catalog.

3. An application which could have negative effects on people, property, or animals requiring special safety analysis.

4. Use in an interlock circuit, which requires the provision of double interlock for possible failure by using a mechanical protective function, and periodical checks to confirm proper operation.



Safety Instructions

Caution

1. The product is provided for use in manufacturing industries.

The product herein described is basically provided for peaceful use in manufacturing industries. If considering using the product in other industries, consult SMC beforehand and exchange specifications or a contract if necessary.
If anything is unclear, contact your nearest sales branch.

Limited warranty and Disclaimer/Compliance Requirements

The product used is subject to the following "Limited warranty and Disclaimer" and "Compliance Requirements".

Read and accept them before using the product.

Limited warranty and Disclaimer

1. The warranty period of the product is 1 year in service or 1.5 years after the product is delivered, whichever is first.*2)

Also, the product may have specified durability, running distance or replacement parts. Please consult your nearest sales branch.

2. For any failure or damage reported within the warranty period which is clearly our responsibility, a replacement product or necessary parts will be provided.

This limited warranty applies only to our product independently, and not to any other damage incurred due to the failure of the product.

3. Prior to using SMC products, please read and understand the warranty terms and disclaimers noted in the specified catalog for the particular products.

***2) Vacuum pads are excluded from this 1 year warranty.**

A vacuum pad is a consumable part, so it is warranted for a year after it is delivered.

Also, even within the warranty period, the wear of a product due to the use of the vacuum pad or failure due to the deterioration of rubber material are not covered by the limited warranty.

Compliance Requirements

1. The use of SMC products with production equipment for the manufacture of weapons of mass destruction (WMD) or any other weapon is strictly prohibited.

2. The exports of SMC products or technology from one country to another are governed by the relevant security laws and regulation of the countries involved in the transaction. Prior to the shipment of a SMC product to another country, assure that all local rules governing that export are known and followed.

Caution

SMC products are not intended for use as instruments for legal metrology.

Products that SMC manufactures or sells are not measurement instruments that are qualified by pattern approval tests relating to the measurement laws of each country.

Therefore, SMC products cannot be used for business or certification ordained by the measurement laws of each country.

Operator

- ◆ This operation manual is intended for those who have knowledge of machinery using pneumatic equipment, and have sufficient knowledge of assembly, operation and maintenance of such equipment. Only those persons are allowed to perform assembly, operation and maintenance.
- ◆ Read and understand this operation manual carefully before assembling, operating or providing maintenance to the product.

■ Precautions

Warning

- Do not disassemble, modify (including changing the printed circuit board) or repair.
An injury or failure can result.
- Do not operate the product outside of the specifications.
Do not use for flammable or harmful fluids.
Fire, malfunction, or damage to the product can result.
Verify the specifications before use.
- Do not operate in an atmosphere containing flammable or explosive gases.
Fire or an explosion can result.
This product is not designed to be explosion proof.
- Do not use with flammable or highly permeable fluids.
Fire, explosion, damage or corrosion can result.
- Do not use the product in a place where static electricity is a problem.
Otherwise it can cause failure or malfunction of the system.
- If using the product in an interlocking circuit:
 - Provide a double interlocking system, for example a mechanical system.
 - Check the product regularly for proper operation.Otherwise malfunction can result, causing an accident.
- The following instructions must be followed during maintenance:
 - Turn off the power supply.
 - Ensure the flow is shut off before performing maintenance.Otherwise an injury can result.

Caution

- Do not touch the terminals and connectors while the power is on.
Otherwise electric shock, malfunction or damage to the product can result.
- Do not touch the piping or its connected parts when the fluid is at high temperature.
It may lead to burnt.
Ensure the piping cools sufficiently before touching.
- After maintenance is complete, perform appropriate functional inspections and leak tests.
Stop operation if the equipment does not function properly or there is a leakage of fluid.
When leakage occurs from parts other than the piping, the product might be faulty.
Disconnect the power supply and stop fluid supply.
Do not apply fluid under leaking conditions.
Safety cannot be assured in the case of unexpected malfunction.

■ NOTE

- Follow the instructions given below when designing, selecting and handling the product.
- The instructions on design and selection (installation, wiring, environment, adjustment, operation, maintenance, etc.) described below must also be followed.
 - *Product specifications
 - Use the specified voltage.
Otherwise failure or malfunction can result.
Insufficient supply voltage may not drive a load due to a voltage drop inside the product.
Verify the operating voltage of the load before use.
 - Do not exceed the specified maximum allowable load.
Otherwise it can cause damage or shorten the life of the product.
 - Input data to the product is not deleted, even if the power supply is cut off. (Number of times of rewriting: 1000000 times)
 - Confirm the pressure loss at the sensor according to the flow rate characteristics (pressure loss) graph before designing piping.
Confirm detection condition of sensor electrified potential.
 - The applicable fluids are water (0 to 90 °C) and ethylene glycol solution with a viscosity of 3 mPa·s (3 cP) or less.
Fluids other than those mentioned above will not be guaranteed.
Do not use fluids containing chemicals, synthetic oils, organic solvents, salt or corrosive gases.
Using such fluids can result in malfunction and damage to the product.
Check the details of the specifications before use.
 - Do not touch the piping or its connected parts when the fluid is at high temperature.
It may lead to burnt.
 - The rated pressure range and proof pressure vary depending on the fluid temperature.
Verify the specifications before use.
 - Consider measures to prevent over pressure due to water hammer.
<Measures to reduce water hammer>
 1. Install a water hammer relieving valve.
 2. Use a flexible material for piping (such as a rubber hose) and an accumulator that can absorb impact pressure.
 3. Keep piping as short as possible.
 - Use the product within the specified operating pressure and temperature range.
 - Reserve a space for maintenance.
Allow sufficient space for maintenance when designing the system.

●Product handling

*Installation

- Tighten to the specified tightening torque.

If the tightening torque is exceeded the mounting screws, brackets and the product can be broken. Insufficient torque can cause displacement of the product from its proper position and the looseness of the mounting screws. (Refer to "Mounting and Installation" on page 18.)

- Be sure to ground terminal FG when using a commercially available switch-mode power supply.

- Do not use in a place subject to heavy vibration and/or shock.

Otherwise damage to the internal parts can result, causing malfunction.

- Do not pull the lead wire forcefully, not lift the product by pulling the lead wire. (Tensile force 49 N or less)

Hold the body when handling to avoid the damage of the product.

The product will be damaged, leading to failure and malfunction.

- For piping of the product, hold the piping with a spanner on the metal part of the piping (Piping attachment).

Applying the spanner to other parts may lead to damage to the product.

In particular, do not let the spanner come into contact with the M8 connector.

The connector can be easily damaged.

- Eliminate any dust left in the piping by air blow before connecting the piping to the product.

Otherwise it can cause damage or malfunction.

- Refer to the flow direction of the fluid indicated on the model number plate or the body for installation and piping.

Residual air can cause errors in measurement accuracy.

- Avoid piping in which the piping size of the IN side of the switch changes suddenly.

If the piping size is reduced sharply or there is a restrictor such as a valve on the IN side, fluid velocity distribution in the piping will be disturbed, leading to improper measurement.

Therefore, the above-mentioned piping should be connected on the OUT side.

If the OUT side is opened, or flow rate is excessive, cavitations may be generated, which may result in improper measurement.

As a measure against this, it is possible to reduce the cavitations by increasing the fluid pressure.

Take action such as mounting an orifice on the OUT side of the switch, and confirm that there is no malfunction before handling.

If the orifice of the OUT side is fully closed to operate the pump, the switch may malfunction due to the effect of pulsation (pressure fluctuation). Ensure that there is no malfunction before usage.

- Do not insert metal wires or other foreign objects into the flow path.

Such actions can damage the sensor causing failure or malfunction.

- Never mount the product in a location that will be used as a scaffold.

The product may be damaged if excessive force is applied by stepping or climbing onto it.

- If the fluid may contain foreign matter, install and connect a filter or mist separator to the inlet.

The adherence of foreign matter to the vortex generator or detector can cause errors in measurement accuracy. A filter of approx. 40 mesh is recommended.

- Design and install the application so that the fluid detection path is always full.

- If the product is mounted vertically, let the liquid flow from bottom to top.

Trapped air bubbles can cause errors in measurement accuracy.

(If the fluid detection path is always filled with liquid, there will be no problem.)

Please be aware that water droplets may cause early deterioration/damage, particularly if the product is installed vertically or upside-down.

- Do not apply excessive rotational force to the monitor.

Rotating the display with excessive force will damage the end stop.

- The product body is made of resin. Do not apply load directly to the product when piping.

This may cause damage, breakage and/or water leakage of the product.

*Wiring

- Do not pull the lead wires. In particular, never lift a product equipped with fitting and piping by holding the lead wires.
Otherwise damage to the internal parts can result, causing malfunction or disconnection from the connector.
- Avoid repeatedly bending, stretching or applying a heavy object or force to the lead wire.
Repetitive bending or tensile stress can cause the sheath of the wire to peel off, or break the wire.
If the lead wire can move, fix it near the body of the product.
The recommended bend radius of the lead wire is 6 times the outside diameter of the sheath, or 33 times the outside diameter of the insulation material, whichever is larger.
Replace a damaged lead wire with a new one.
- Wire correctly.
Incorrect wiring can break the product.
- Do not perform wiring while the power is on.
Otherwise damage to the internal parts can result, causing malfunction.
- Do not route wires and cables together with power or high voltage cables.
Otherwise the product can malfunction due to interference of noise and surge voltage from power and high voltage cables to the signal line. Route the wires (piping) of the product separately from power or high voltage cables.
- Confirm proper insulation of wiring.
Poor insulation (interference from another circuit, poor insulation between terminals, etc.) can lead to excess voltage or current being applied to the product, causing damage.
- Keep wiring as short as possible to prevent interference from electromagnetic noise and surge voltage.
Do not use a cable longer than 20 m.
Wire the DC(-) line (blue) as close as possible to the power supply.
- When the analogue output is used, install a noise filter (line noise filter, ferrite element, etc.) between the switch-mode power supply and this product.

*Environment

- Do not use the product in an environment that is constantly exposed to the splash of water.
Otherwise failure or malfunction can result. Take measures such as using a cover.
- Do not use the product in an environment where corrosive gases or fluids could be splashed.
Otherwise damage to the product and malfunction can result.
- Do not use in a place where the product could be splashed by oil or chemicals.
If the product is used in an environment containing oils or chemicals such as coolant or cleaning solvent, even for a short time, it may be adversely affected (damage, malfunction, or hardening of the lead wires).
- Do not use in an area where surges are generated.
When a machine or equipment generating large surge near the product (magnetic type lifter, high frequency inductive furnace, motor, etc.), this can result in malfunction (display of incorrect value), deterioration and damage of internal elements. Take measures against the surge sources, and prevent the lines from coming into close contact.
- Do not use a load which generates surge voltage.
When a surge-generating load such as a relay or solenoid is driven directly, use a Flow switch with a built-in surge absorbing element.
- The product is CE marked, but not immune to lightning strikes. Take measures against lightning strikes in the system.
- Mount the product in a location that is not affected by vibration or impact.
Otherwise failure or malfunction can result.
- Do not use the product in the presence of a magnetic field.
Such use can result in malfunction of the product.
- Do not let foreign matter, such as wire debris, get inside the product.
To prevent malfunction or failure take measures to prevent the debris entering the product.
- Do not use this product in places where there are cyclic temperature changes.
Heat cycles other than ordinary changes in temperature can adversely affect the inside of the product.
- Do not expose the product to direct sunlight.
If using in a location directly exposed to sunlight, shade the product from the sunlight.
Otherwise failure or malfunction can result.
- Keep within the specified fluid and ambient temperatures range.
If the fluid freezes, it may cause damage and malfunction of the switch, so please take measures to prevent freezing.
When a fluid at a lower temperature than the ambient temperature is supplied, the product can break due to condensation and malfunction. Keep the product from having condensation.
Protection against freezing is necessary.
Avoid sudden temperature change even within specified temperature. Otherwise failure or malfunction can result.
- Do not operate close to a heat source, or in a location exposed to radiant heat.
This can cause operating failure.

*Adjustment and Operation

- Connect a load before turning the power supply on.
- Do not short-circuit the load.

Although error is displayed when the product load has a short circuit, generated over current lead to cause the damage of the product.

- Do not press the setting buttons with a sharp pointed object.
It may damage the setting buttons.

- Supply the power when there is no flow.

- The product is compulsory turned off for 3 seconds after the power is supplied.

- Perform settings suitable for the operating conditions.

Incorrect settings can cause operational failure.

For details of each setting, refer to page 26 to 68 of this manual.

- During the initial setting and flow rate setting, the product will switch the measurement output with the condition before setting.

Confirm the output has no adverse effect on machinery and equipment before setting.

Stop the control system before setting if necessary.

- Do not touch the LCD display during operation.

The display can vary due to static electricity.

- The product is a flow meter using Karman vortex. The flow meter using Karman vortex has lower output frequency at excess flow state. Do not use the product within the excess flow area in the chart below.

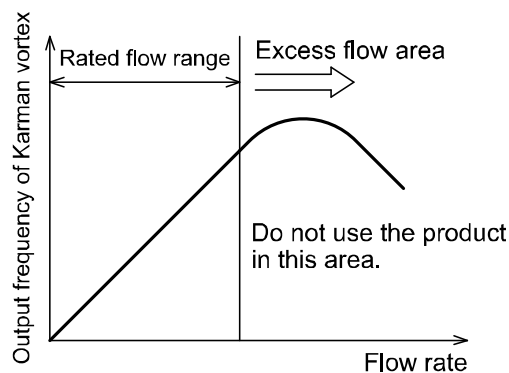

*Maintenance

- Turn off the power supply, stop the fluid and check the safety before performing any maintenance.
There is a risk of unexpected malfunction.

- Perform regular maintenance and inspections.

There is a risk of unexpected malfunction of components due to the malfunction of equipment and machinery.

- Do not use solvents such as benzene, thinner etc. to clean the product.

They could damage the surface of the product and erase the indication on the product.

Use a soft cloth to remove stains. For heavy stains, use a cloth soaked with diluted neutral detergent and fully squeezed, then wipe up the stains again with a dry cloth.

*Handling of flow adjustment valve

- When flow is adjusted with the flow adjustment valve, do not apply excessive force to rotate it.
This can damage the valve mechanism.
- When fixing the valve of the flow adjustment valve, do not apply excessive force to rotate the fixing knurl.
This can damage the knurl and valve mechanism.
- After adjusting the flow, be sure to check that there is no water leakage.
After adjusting the flow, water leakage may occur due to the stability of the seal in the valve. If water leakage occurs, open and close the valve several times to readjust it, and check that there is no water leakage.
- The flow rate adjustment valve of this product is not suitable for applications which require constant adjustment of flow rate.
Fluid leakage may be generated when the internal seal reaches the end of its life due to wearing. Therefore, take measures to protect peripheral equipment, ensure maintenance space and pay attention to the piping design.
- The flow rate adjustment valve of this product is not suitable for applications which require reducing the flow rate to zero completely. If it is necessary to reduce the flow rate to zero completely, install a stop valve etc. separately.
- Do not lift it by gripping the knob of the flow adjustment valve.
Hold the body when handling to avoid damaging the product.
- If fluids with high temperature are flowed, the flow adjustment valve itself will also become hot, which leads to a burn. Therefore, use the flow adjustment valve with special care.

Model Indication and How to Order

PF3W7 - - - Z

Integrated display type

Rated flow range (Flow range)

Symbol	Content
04	0.5 to 4 L/min
20	2 to 16 L/min
40	5 to 40 L/min
11	10 to 100 L/min

Flow adjustment valve

Symbol	Adjustment valve	Rated flow range			
		04	20	40	11
Nil	None	●	●	●	●
S	With adjustment valve	●	●	●	-

*1: 100 L/min types with flow adjustment valves is not available.

*2: The flow adjustment valve of this product is not suitable for applications which require constant adjustment of flow rate.

Thread type

Symbol	Content
Nil	Rc
N	NPT
F	G *

*: ISO228 equivalent

Port size

Symbol	Port size	Rated flow range			
		04	20	40	11
03	3/8	●	●	-	-
04	1/2	-	●	●	-
06	3/4	-	-	●	●
10	1/1	-	-	-	●

Output specification/Temperature sensor

Symbol	Output specification		Temp. sensor
	OUT1	OUT2	
	Flow rate/temp.	Flow rate/temp.	
L	IO-Link/Switch output (N/P)	-	Without temp. sensor
L2	IO-Link/Switch output (N/P)	Switch output (N/P)	With temp. sensor
LT	IO-Link/Switch output (N/P)	-	
L2T	IO-Link/Switch output (N/P)	Switch output (N/P)	

*: For units with temp. sensor, switch outputs can be set as either temp. output or flow rate output.

Option 3

Symbol	Content
Nil	None
A	With calibration certificate

*: The certificate is written in both English and Japanese.

Integrated display type with temp. sensor can only display flow rate.

The temp. sensor is not calibrated.

Option 2

Symbol	Content
Nil	None
R	With bracket

Unit specification

Symbol	Instantaneous flow rate	Accumulated flow	Temp.
Nil	gal/min	gal	°C
M	L/min	L	°C

*: Under the New Measurement Law, units other than SI (symbol "M") cannot be used in Japan.

*: Reference: 1 [L/min] = 0.2642 [gal/min]
1 [gal/min] = 3.785 [L/min]
°F = 9/5 °C + 32

Option 1

Symbol	Content
Nil	With lead wire with M8 connector (3 m)
N	None
Q	With M12-M8 conversion lead wire (0.1 m)

PF3W7 21-□□-□□-□□□

Integrated display type

Rated flow range (Flow range)

Symbol	Content
21	50 to 250 L/min

Thread type

Symbol	Content
Nil	Rc
N	NPT
F	G *

*: ISO228 equivalent

Port size

Symbol	Port size
12	1-1/4
14	1-1/2

Option 3

Symbol	Content
Nil	None
A	With calibration certificate

*: The certificate is written in both English and Japanese.
Integrated display type with temp. sensor can only display flow rate.
The temp. sensor is not calibrated.

Option 2

Symbol	Content
Nil	None
R	With bracket

Unit specification

Symbol	Instantaneous flow rate	Accumulated flow	Temp.
Nil	gal/min	gal	°C
M	L/min	L	°C

*: Under the New Measurement Law, units other than SI (symbol "M") cannot be used in Japan.
*: Reference: 1 [L/min] = 0.2642 [gal/min]
1 [gal/min] = 3.785 [L/min]
°F = 9/5 °C + 32

Option 1

Symbol	Content
Nil	With lead wire with M8 connector (3 m)
N	None
Q	With M12-M8 conversion lead wire (0.1 m)

Output specification/Temperature sensor

Symbol	Output specification		Temp. sensor
	OUT1	OUT2	
	Flow rate/temp.	Flow rate/temp.	
L	IO-Link/Switch output (N/P)	-	Without temp. sensor
L2	IO-Link/Switch output (N/P)	Switch output (N/P)	
LT	IO-Link/Switch output (N/P)	-	With temp. sensor
L2T	IO-Link/Switch output (N/P)	Switch output (N/P)	

*: For units with temp. sensor, switch outputs can be set as either temp. output or flow rate output.

Lead wire

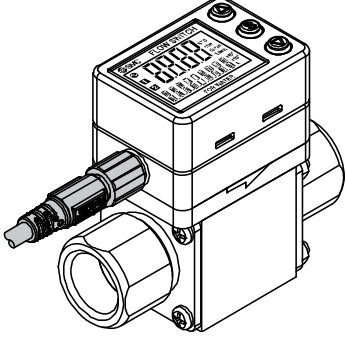
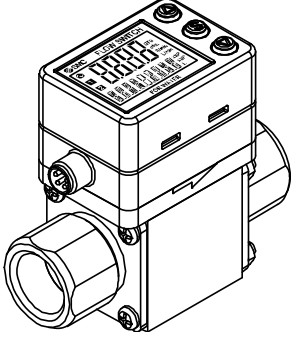
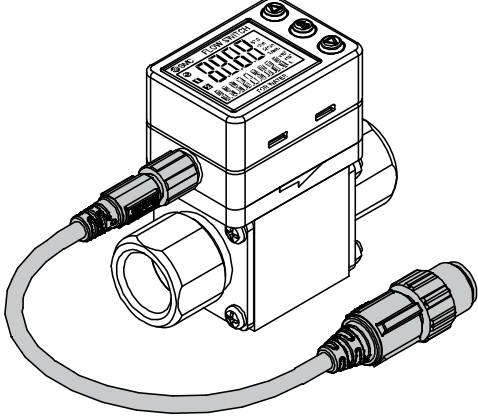
NIL	N	Q
With M8 connector and lead wire	With M8 connector and no lead wire	With M12-M8 connector and lead wire
		

Bracket

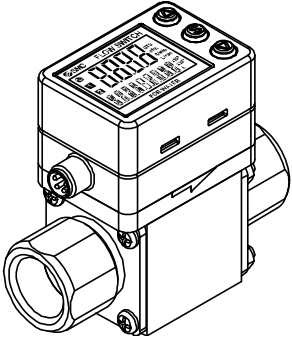
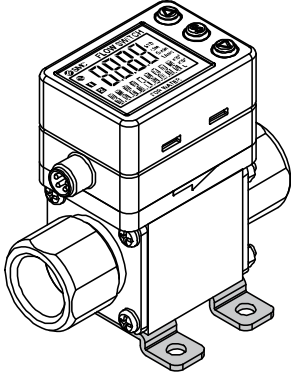
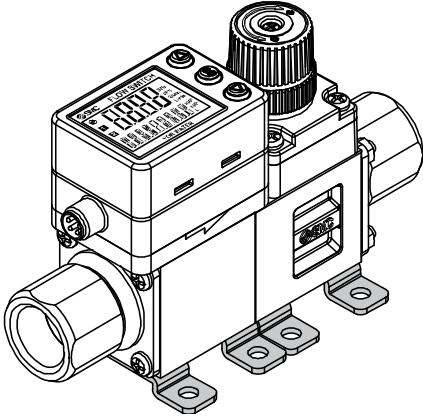
NIL	R	
Without bracket	With bracket	With flow adjustment valve
		

Options/Part number

If an option is required independently, order using the following part number.

Option	Part number	Remarks
Bracket *	ZS-40-K	Taptite screw for PF3W704/720 (3 x 8), 4 pcs.
	ZS-40-L	Taptite screw for PF3W740 (3 x 8), 4 pcs.
	ZS-40-M	Taptite screw for PF3W711 (4 x 10), 4 pcs.
Lead wire with M8 connector	ZS-40-A	Lead wire length: 3 m
Lead wire with M12-M8 connector	ZS-40-M12M8-A	For converting M12 to M8

*: 2 brackets are necessary if using the type with flow rate adjustment valve.

Summary of Product parts

Body

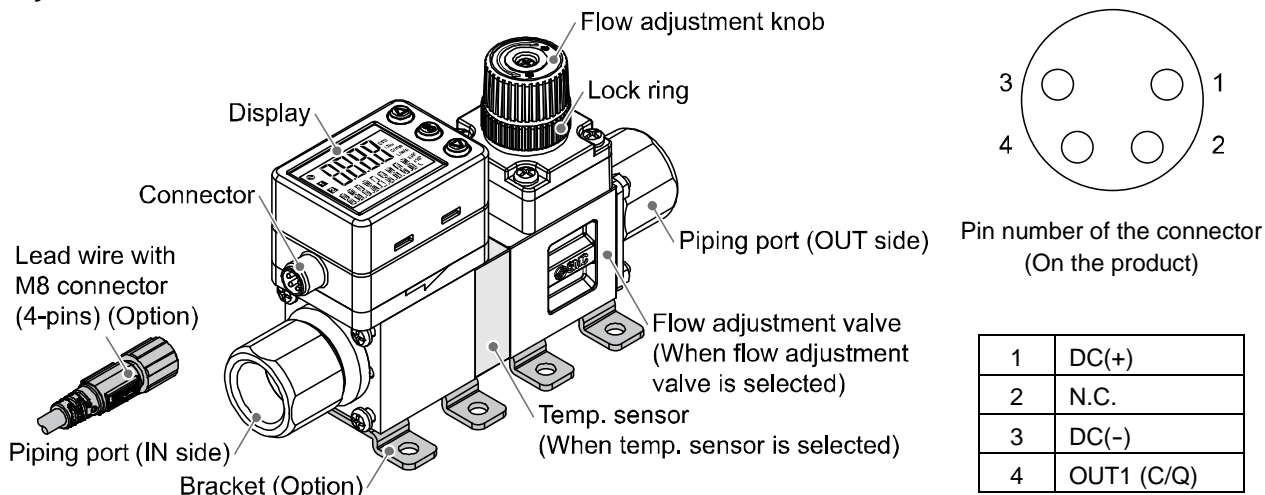



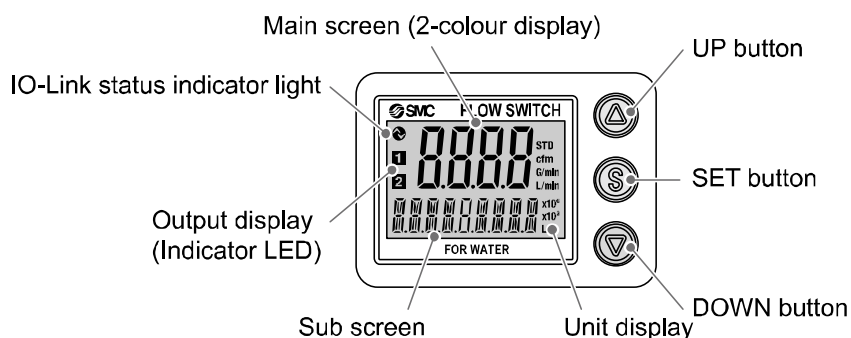

Element	Description
Connector	Connector for electrical connections.
Lead wire with M8 connector	Lead wire to supply power and transmit output signals.
Piping port	Port to connect the fluid inlet at IN and fluid outlet at OUT.
Bracket	Bracket for mounting the product.
Temperature sensor	Sensor for detecting the fluid temperature.
Flow adjustment valve	Restricting valve to adjust the flow rate.
Flow adjustment knob	Knob for adjusting the flow rate.
Lock ring	Ring for locking the flow adjustment valve.
Display	Displays the flow, settings and error codes (See below).



Display



Element	Description
Main screen (2-colour display)	Displays the flow, the status of setting mode and error code.
Sub screen	Displays the accumulated flow, set value, peak/bottom value, fluid temperature and line names.
Output display (Indicator LED)	Displays the output status of OUT1 and OUT2. When ON: Orange LED is ON.
Unit display	Displays the unit selected.
UP button	Selects a mode and the display shown at the sub screen, and increases the ON/OFF set values.
SET button	Press this button to select mode and to confirm a set value.
DOWN button	Selects a mode and the display shown at the sub screen, and decreases the ON/OFF set values.
IO-Link status indicator light	LED is ON when OUT1 is used in IO-Link mode. (LED is OFF in SIO mode)

●IO-Link indicator light operation and display

Communication with master	IO-Link status indicator light	Status		Sub screen display *1	Content	
						
Yes		IO-Link mode	Correct	Operate	ModE oPE	Normal communication status (Reading of measurement value)
				Start up	ModE St rE	When communication starts up.
				Preoperate	ModE PrE	
			Abnormal	Version does not match	Er 15 V 1.0	Version of master and IO-Link does not match *2
				Lock	ModE LoL	Back-up and re-store required due to data storage lock
No		SIO mode	Communication shut-off	ModE St rE ModE PrE ModE oPE	Correct communication was not received for 1 second or more.	
				ModE S IO	General switch output	

LCD display: "O" OFF, "" Flashing, "" ON

*1: "ModE - - -" is displayed when selecting the modes on the sub screen.

*2: When the product is connected to the master with version "V1.0", error Er15 is generated.

■ Definition and terminology

	Terms	Meaning
A	Accumulated flow	The total amount of fluid that has passed through the device. If an instantaneous flow of 10 L/min continues for 5 minutes, the accumulated flow will be $10 \times 5 = 50$ L.
	Accumulated flow external reset	A function to reset the accumulated flow to zero by using an external signal.
	Accumulated pulse output	A type of output where a pulse is generated every time a predefined accumulated flow passes. It is possible to calculate the total accumulated flow by counting the pulses.
	Analogue output	Outputs a value proportional to the flow rate. When the analogue output is in the range 1 to 5 V, it will vary between 1 to 5 V according to the rate of flow. The same for analogue output of 4 to 20 mA.
	Attachment	A metal part at both sides of the product to connect piping.
C	Cavitation	A phenomenon that may occur in a fluid moving at high speed. In the parts of the fluid where the pressure is low, vapour bubbles form and then rapidly collapse. If cavitation is present for a prolonged period, exposed surfaces will be damaged; this is called cavitation damage or erosion.
	Chattering	The problem of the switch output turning ON and OFF repeatedly around the set value at high frequency due to the effect of pulsation.
D	Delay time	The setting time from when the flow applied to the flow switch reaches the set value, to when the ON-OFF output actually begins working. Delay time setting can prevent the output from chattering. The response time indicates when the set value is 90% in relation to the step input.
	Display flow range	The range of measured values that can be displayed for a product with a digital display.
	Digital filter	Function to add digital filtering to the fluctuation of flow value. Smooth the fluctuation of displayed value for sharp start up or fall of the flow. When the function is valid, digital filtering is reflected to the ON/OFF of the switch output. Output chattering or flicker in the measurement mode display can be reduced by setting the digital filter.
F	Fluid temperature	Range of fluid temperature that can be measured by the product.
	F.S. (Full span, Full scale)	Stands for "full span" or "full scale", and indicates varied display value and analogue output range at rated value. For example, when analogue output is 1 to 5 V, F.S. = $5[V] - 1[V] = 4[V]$, (ref. $1\%F.S. = 4[V] \times 1\% = 0.04[V]$)
H	Holding of accumulated flow	A function to store the accumulated flow value in the product's internal memory. The flow value will be stored at a set time interval of either 2 or 5 minutes. When the power supply is turned on, the stored accumulated flow value will be displayed and accumulated flow will continue from that point.
	Hysteresis	The difference between ON and OFF points used to prevent chattering. Hysteresis can be effective in avoiding the effects of pulsation.
	Hysteresis mode	Mode where the switch output will turn ON when the flow is greater than the set value, and will turn off when the flow falls below (set value – hysteresis value).

	Terms	Meaning
I	Instantaneous flow	The flow passing per unit of time. If it is 10 L/min, there is a flow of 10 L passing through the device in 1 minute.
	Internal voltage drop	The voltage drop across the product (and therefore not applied to the load), when the switch output is ON. The voltage drop will vary with load current, and ideally should be 0 V.
K	Karman vortex	When an object is placed in a fluid stream, a vortex will be created in the fluid on the downstream side. This vortex is called a Karman vortex. The frequency at which the vortices are generated is proportional to the fluid velocity, therefore it is possible to calculate the fluid flow rate by measuring the Karman vortex frequency.
	Key-lock function	This function prevents the set value from being changed by mishandling.
M	Measured fluid	The fluid(s) that the product can measure.
	Min. setting unit	The resolution of set and display values. If the minimum setting unit is 1 L/min, the display will change in 1 L/min steps, e.g. 10.....11.....12 L/min.
O	Operating pressure range	Pressure range in which product is operable.
	Operating temp. range	Ambient temperature range in which product is operable.
P	Part in contact with fluid (wetted part)	A part that comes into physical contact with the fluid.
	Pressure characteristics	Indicates the change in the display value and analogue output when fluid pressure changes.
	Proof pressure	Burst pressure at which the product is electrically or mechanically damaged.
R	Rated flow range	The flow range within which the product will meet all published specifications.
	Rated pressure range	The pressure range that satisfies the specifications.
	Repeatability	Reproducibility of the display or analogue output value, when the measured quantity is repeatedly increased and decreased.
S	Set flow range	The range of ON/OFF threshold values that can be set for those products with a switch output.
	Switch output	Output type that has only 2 conditions, ON or OFF. When in the ON condition an indicator light will show, and any connected load will be powered. When in the OFF condition, there will be no indicator light and no power supplied to the load.
T	Temperature characteristics	Indicates the change in the display value and analogue output caused by ambient temperature changes.
U	Unit selection function	A function to select display units other than the international unit (SI unit) specified in the new Japanese measurement law. Flow can only be displayed by SI units in Japan.
W	Water hammer	A momentary steep pressure increase due the spread of pressure by closing a contactor such as a valve for an extremely short time while there is a flow. This pressure increase is known as water hammer or impact pressure.
	Window comparator mode	An operating mode in which the switch output is turned on and off depending on whether the flow is inside or outside the range of two set values.

Mounting and Installation

Installation

- Use the product within the specified operating pressure and temperature range.
- Proof pressure could vary according to the fluid temperature. Check the characteristics data for operating pressure and proof pressure.

Mounting

- Never mount the product in a location where it will be used as a support.
- Mount the product so that the fluid flows in the direction indicated by the arrow on the side of the body.
- Check the flow characteristics data for pressure loss and the straight inlet pipe length effect on accuracy (page 97), to determine inlet piping requirements.
- Do not sharply reduce the piping size.
- The monitor with integrated display can be rotated. It can be set at 90° intervals clock and anticlockwise, and also at 45° and 225° clockwise. Rotating the display with excessive force will damage the end stop.

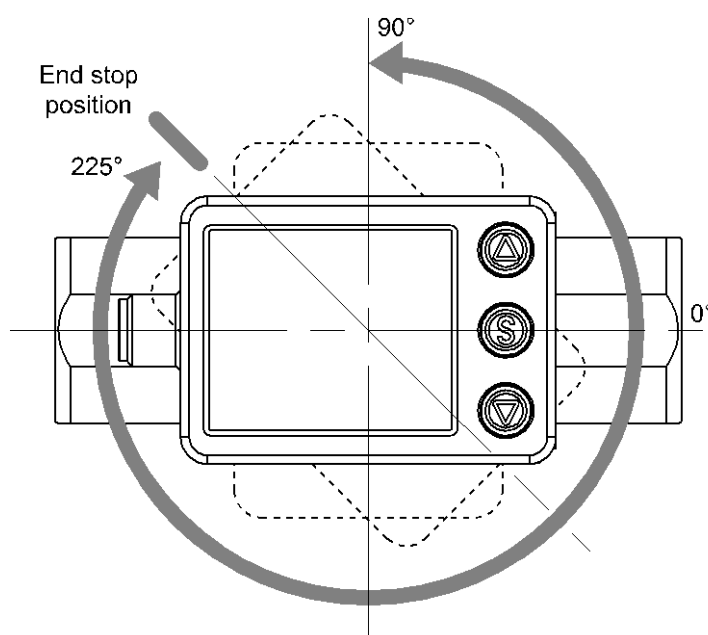

■ Installation

Bracket mounting (PF3W704/720/740)

Mount the product (with bracket) using the mounting screws supplied (M4 x 4 pcs.).

For models with flow adjustment valve attached, fix using 8 mounting screws.

Bracket thickness is approx. 1.5 mm.

Refer to the outline dimension drawing (page 100) for mounting hole sizes.

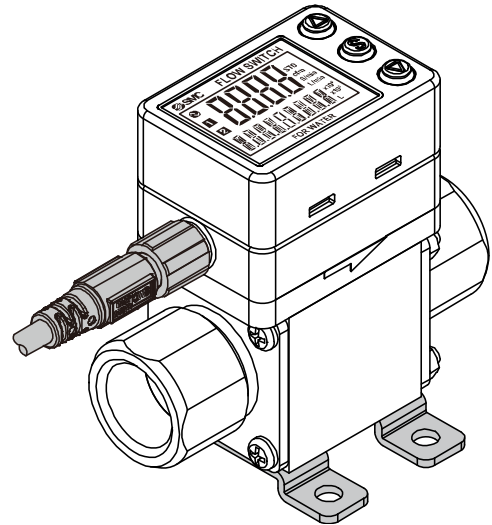

Bracket mounting (PF3W711)

Mount the product (with bracket) using the mounting screws supplied (M5 x 4 pcs.).

Bracket thickness is approx. 2 mm.

Refer to the outline dimension drawing (page 100) for mounting hole sizes.

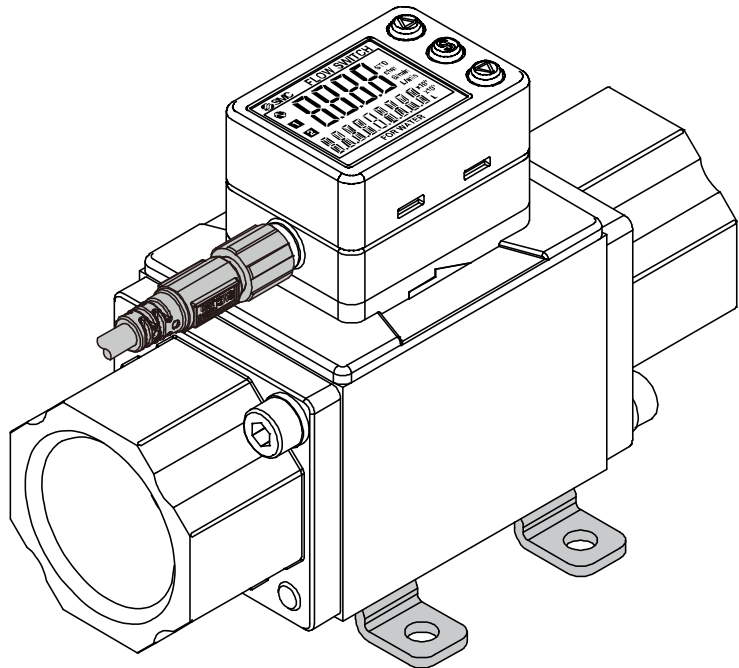

Direct mounting (PF3W704/720/740)

Mount using the self tapping screws (nominal size: 3.0 x 4 pcs.) for installation.
For models with flow adjustment valve attached, mount using 8 self tapping screws.
The tightening torque must be 0.5 to 0.7 Nm.
Refer to the outline dimension drawing (page 100) for mounting hole dimensions.
The self tapping screws should not be re-used.

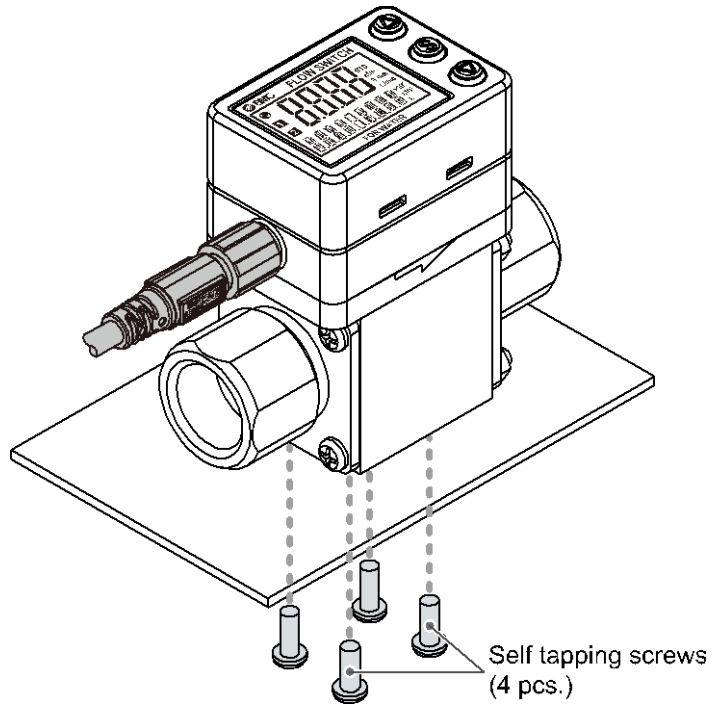

Direct mounting (PF3W711)

Mount using the self tapping screws (nominal size: 4.0 x 4 pcs.) for installation.
The tightening torque must be 1.0 to 1.2 Nm.
Refer to the outline dimension drawing (page 100) for mounting hole dimensions.
The self tapping screws should not be re-used.

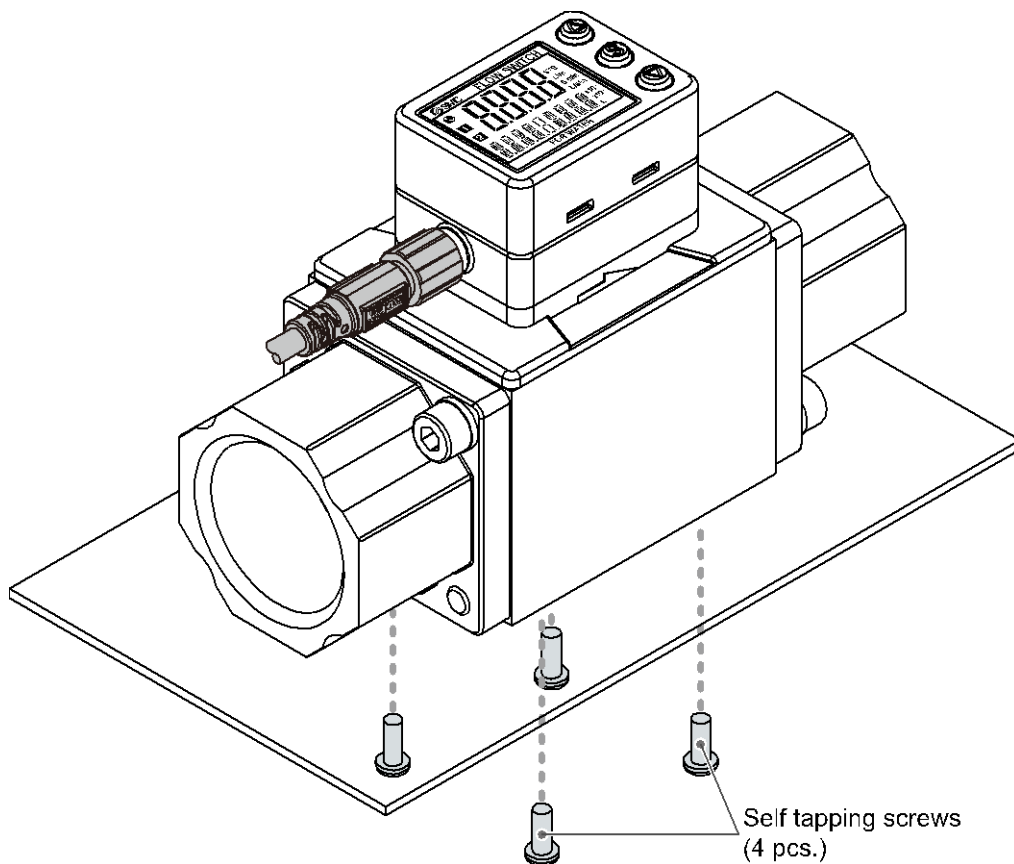

■Piping

When connecting piping to the product, a spanner should be used on the metal piping attachment only. Using a spanner on other parts may damage the product.

In particular, do not let the spanner come into contact with the M8 connector.

The connector can be easily damaged.

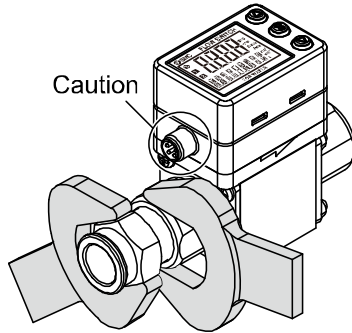

Width across flats of attachment

3/8	20.9 mm
1/2	23.9 mm
3/4	29.9 mm
1	41 mm

After hand tightening the piping, apply a spanner of the correct size to the spanner flats on the product, and tighten it for 2 to 3 rotations.

The tightening torque is shown in the table below.

Nominal thread size	Tightening torque
Rc(NPT)3/8	15 to 20 Nm
Rc(NPT)1/2	20 to 25 Nm
Rc(NPT)3/4	28 to 30 Nm
Rc(NPT)1	36 to 38 Nm
Rc(NPT)1 1/4	40 to 42 Nm
Rc(NPT)1 1/2	48 to 50 Nm

If the tightening torque is exceeded, the product can be broken. If the correct tightening torque is not applied, the fittings may become loose.

Avoid any sealing tape getting inside the piping.

Ensure there is no leakage from loose piping.

Caution

The product body is made of resin. The installation and piping of the product must satisfy the following requirements.

This may cause damage, breakage and/or water leakage of the product.

- No load should be directly applied to the product.



- Do not install piping to the product with a misalignment.
A permanent load will be applied to the product after piping.

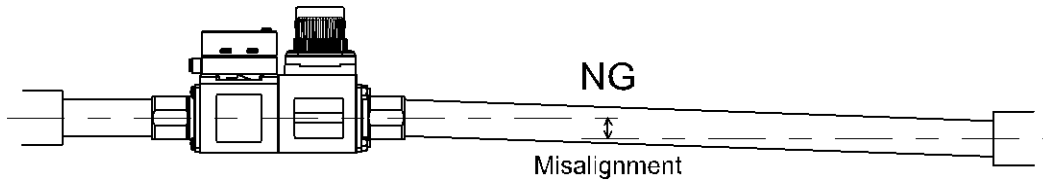

- When a flexible hose is used for the piping, the hose must be fixed with a bracket etc.
If it is not fixed, the load weight of the flexible hose and the fluid will be applied to the product.

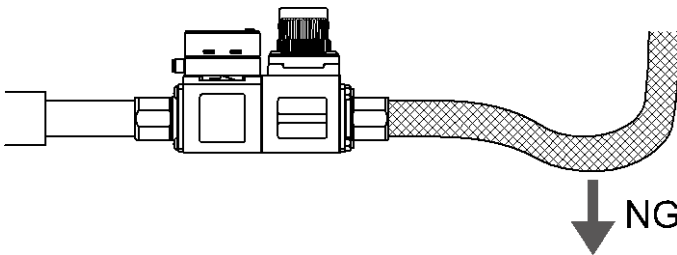

How to adjust the flow rate (when a flow adjustment valve is mounted)

- (1) Rotate the knob of the valve to adjust the flow rate to the target value.
- (2) Be sure to confirm that there is no fluid leakage generated after adjustment.
(When fluid leakage is generated, open and close the valve several times for re-adjustment, and confirm that there is no fluid leakage.)
- (3) Tighten the lock ring to fix the valve as necessary.

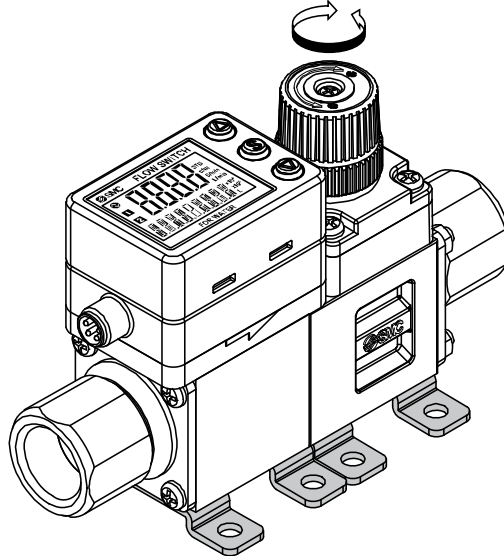

The flow adjustment valve is not designed for applications that require daily and repetitive adjustment. If the valve is adjusted frequently, fluid may leak due to wear of the internal seal.

■ Wiring

Wiring of connector

Connections should only be made with the power supply turned off.

Use separate routes for the Flow switch wiring and any power or high voltage wiring. Otherwise, malfunction may result due to noise.

Ensure that the FG terminal is connected to ground when using a commercially available switch-mode power supply. When a switch-mode power supply is connected to the product, switching noise will be superimposed and the product specification can no longer be met. This can be prevented by inserting a noise filter, such as a line noise filter and ferrite core, between the switch-mode power supply and the product, or by using a series power supply instead of a switch-mode power supply.

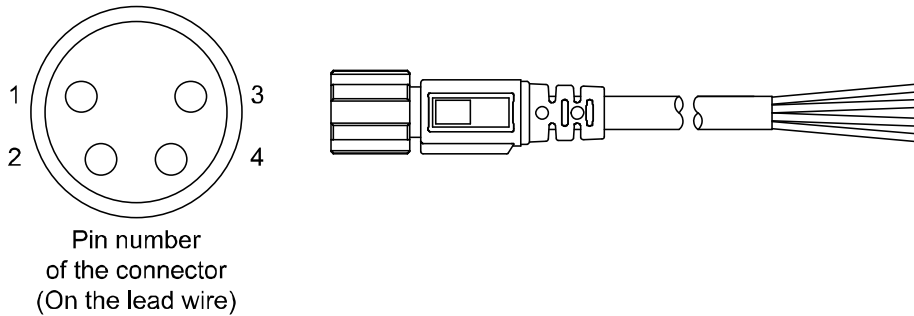

Used as switch output device

No.	Name	Lead wire colour	Function
1	DC(+)	Brown	12 to 24 VDC
2	N.C./OUT2	White	Not connected/Switch output 2 (SIO)
3	DC(-)	Blue	0 V
4	OUT1	Black	Switch output 1

Used as IO-Link device

No.	Name	Lead wire colour	Function
1	L+	Brown	18 to 30 VDC
2	N.C./OUT2	White	Not connected/Switch output 2 (SIO)
3	L-	Blue	0 V
4	C/Q	Black	Communication data (IO-Link)/Switch output 1 (SIO)

*: When using the lead wire with M8 connector included with the PF3W7 series.

Tighten the connector by hand.

Examples of Internal Circuit and Wiring

•NPN output type

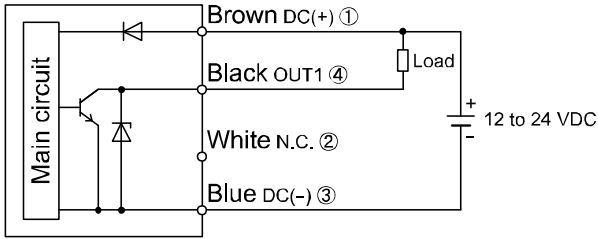

Max.28 V, 80 mA
Internal voltage drop 1.5 V or less

•PNP output type

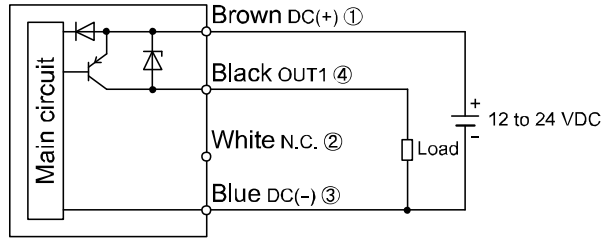

Max.80 mA
Internal voltage drop 1.5 V or less

•NPN 2 Output type

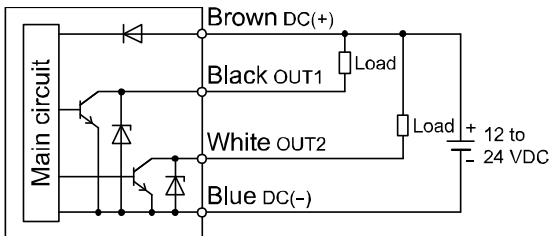

Maximum 28 V, 80 mA
Internal voltage drop 1.5 V or less

•PNP 2 Output type

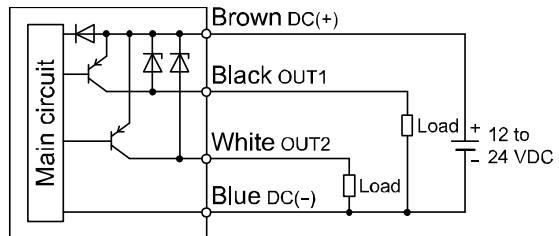

Maximum 80 mA
Internal voltage drop 1.5 V or less

•Used as IO-Link device

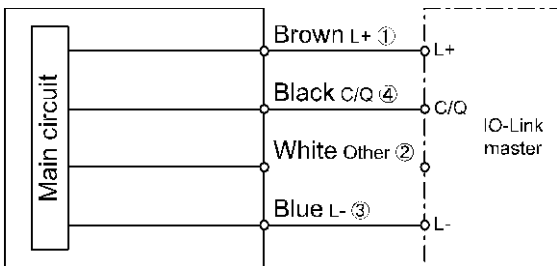

*: Numbers in the figures show the connector pin layout.

Example of wiring for accumulated pulse output

NPN output type

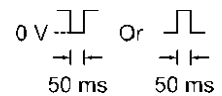
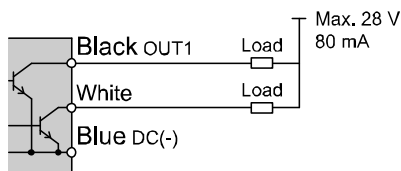

PNP output type

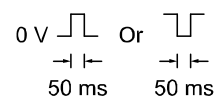
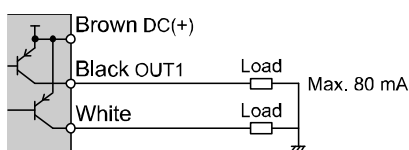

When accumulated pulse output is selected, the indicator light is turned off.
The white wire (OUT2) is used only when the 2 output type is selected.

Flow Setting

Measurement mode

The mode in which the flow is detected and displayed, and the switch function is operating. This is the basic operating mode; other modes should be selected for set-point and other function setting changes.

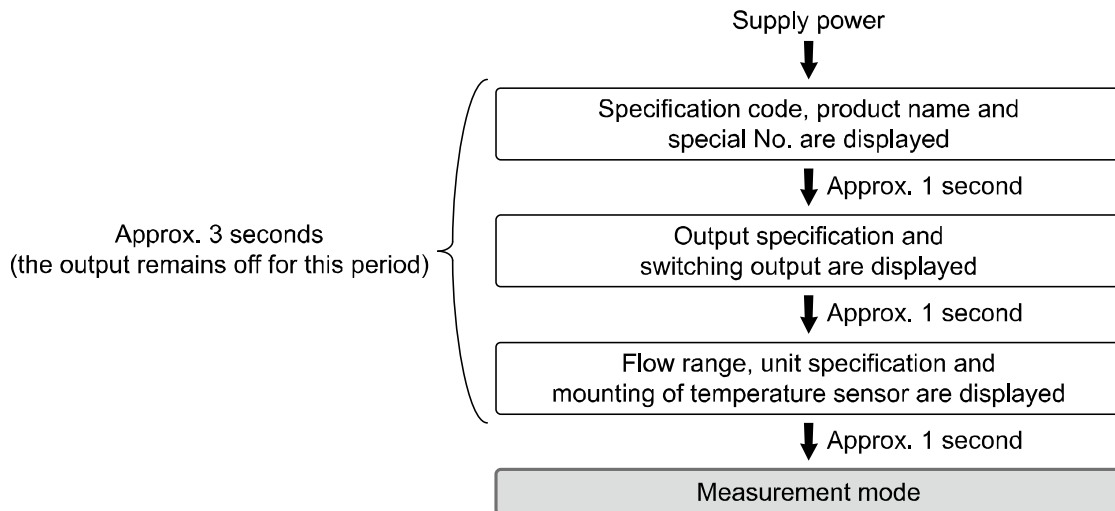

- *: The outputs will continue to operate during setting.
- *: If a button operation is not performed for 30 seconds during the setting, the display will flash (This is to prevent the setting from remaining incomplete if, for instance, an operator were to leave during setting).
- *: 3 step setting mode and Function selection mode are reflected on each other.

Display of sub screen

In measurement mode, the display of the sub screen can be temporarily changed by pressing the UP or DOWN buttons.

After 30 seconds, it will automatically reset to the display selected in [F10]. (Refer to page 50.)
(Example shown is for 16 L/min type)

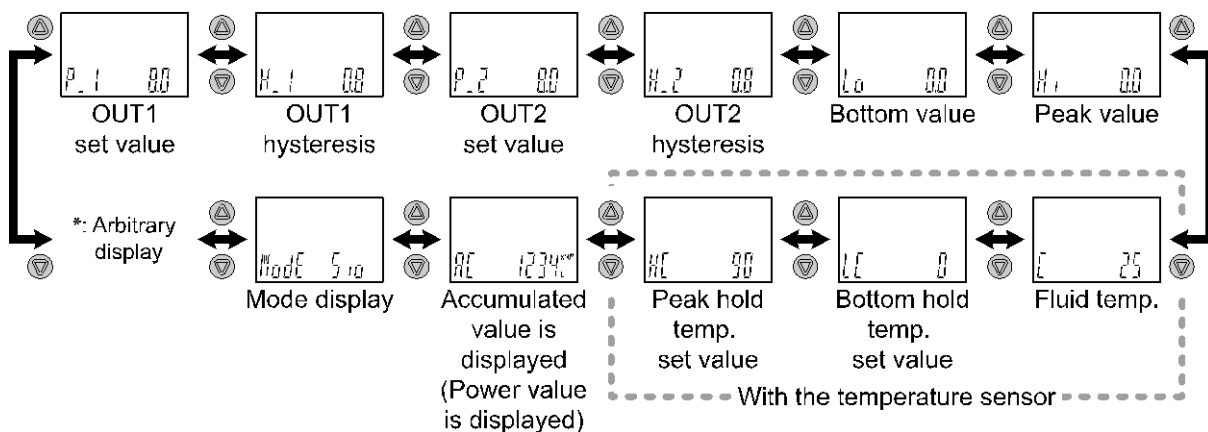

- *: An arbitrary display can be added to the sub display by setting in [F10].
If the sub display is switched during the arbitrary display, the display will return to the arbitrary display 30 seconds later.
(The default setting does not include arbitrary display).

Default settings

When the flow exceeds the set value, the switch will be turned ON.

When the flow falls below the set value by the amount of hysteresis or more, the switch will be turned OFF.

If the operation shown the below is acceptable, please keep this setting.

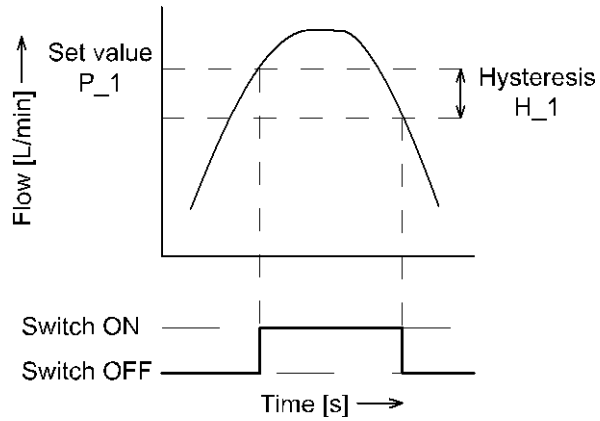

Refer to the following pages for how to change the settings.

*: For input of hysteresis, perform the settings referring to [F 1] Setting of OUT1 (page 34 to) and [F 2] Setting of OUT2 (page 42 to).

<Operation of the set value change > (3 step setting mode)

1. Press the SET button in measurement mode to display set values.
(The item to be changed is displayed on the sub display)
Set value on the right side of the sub screen flashes.

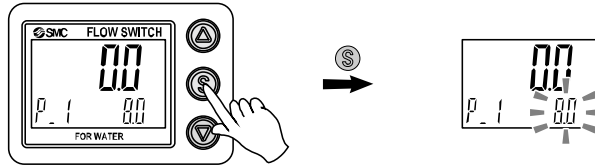

2. Press the UP or DOWN button to change the set value.
The UP button is to increase and the DOWN button is to decrease the set value.

- Press the UP button once to increase by one digit, or press and hold to continuously increase.

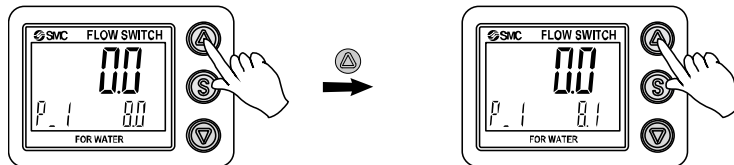

- Press the DOWN button once to decrease by one digit, or press and hold to continuously decrease.

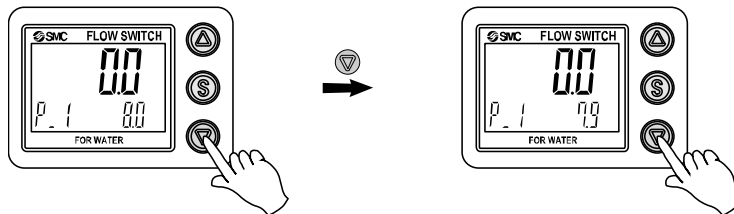

3. Press the SET button to finish the setting.

- *: For input of hysteresis, perform the settings referring to [F 1] Setting of OUT1 (page 34).
- *: When a mode other than hysteresis mode is selected, "Set value" of page 35 is displayed.
- *: Note that the set value and hysteresis are limited by each other.
- *: For more detailed settings, set each function in function selection mode (page 30).

Simple Setting Mode

<Operation>

[Simple setting mode (hysteresis mode)]

In the simple setting mode, the set value and hysteresis can be changed while checking the current flow value (main screen).

- (1) Press and hold the SET button for 1 to 3 seconds in measurement mode. [SEt] is displayed on the main screen. When the button is released while in the [SEt] display, the current flow value is displayed on the main screen, [P_1] or [n_1] is displayed on the sub screen (left side), and the set value is displayed on the sub screen (right side) (Flashing).

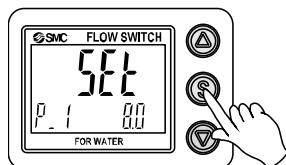

- (2) Change the set value with the UP or DOWN button, and press the SET button to set the value. Then, the setting moves to hysteresis setting. (The snap shot function can be used. (Refer to page 65))

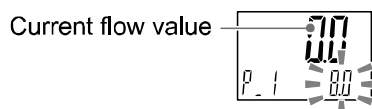

- (3) Change the set value with the UP or DOWN button, and press the SET button to set the value. Then, the setting moves to the setting of OUT2. (The snap shot function can be used. (Refer to page 65))



- (4) Press the SET button for less than 2 seconds to complete the OUT1 setting. [P_2] or [n_2] is displayed on the sub screen (left side). Continue with setting the OUT2. Press and hold the SET button for 2 seconds or longer to complete the setting. The product will return to measurement mode.

*1: Selected items (1) to (3) become valid after pressing the SET button.

*2: After enabling the setting by pressing the SET button, it is possible to return to measurement mode by pressing the SET button for 2 seconds or longer.

*3: When the output mode (refer to page 35) is set to error output or output OFF, the simple setting mode cannot be used. (The setting changes to measurement mode by releasing the button when [SEt] is displayed.)

Function Setting

Function selection mode

In measurement mode, press the SET button for 3 to 5 seconds to display [F□□] on the main screen.

Select to display the function to be change [F□□].

Press and hold the SET button for 2 seconds or longer in function selection mode to return to measurement mode.

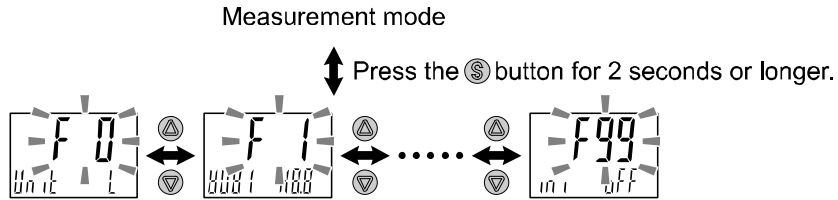

The function number is increased and decreased by the UP and DOWN buttons.
Display the required function number and press the SET button.

■Default settings

Item		Default setting	Page
[F 0]	[Unit] Display unit setting	[L] L/min, °C	Page 33
	[NorP] Switching setting of switch output NPN/PNP	[PnP] PNP output	Page 33
[F 1]	[oUt1] Output mode (OUT1)	[HYS] Hysteresis mode	Page 35
	[1ot] Switch operation (OUT1)	[1_P] Normal output	Page 35
	[P_1] Set value (OUT1)	50% of maximum rated flow [2.00] 2.00 L/min (4 L type) [8.0] 8.0 L/min (16 L type) [20.0] 20.0 L/min (40 L type) [50] 50 L/min (100 L type)	Page 35
	[H_1] Hysteresis (OUT1)	5% of maximum rated flow [0.20] 0.20 L/min (4 L type) [0.8] 0.8 L/min (16 L type) [2.0] 2.0 L/min (40 L type) [5] 5 L/min (100 L type)	Page 36
	[dtH1] Delay time setting at ON	[0.00] 0.00 s	Page 36
	[dtL1] Delay time setting at OFF	[0.00] 0.00 s	Page 36
	[CoL] Display colour (OUT1)	[1SoG] ON: Green, OFF: Red (OUT1)	Page 39

	Item	Default setting	Page
[F 2] *: When a temp. sensor is not connected	[oUt2] Output mode (OUT2)	[HYS] Hysteresis mode	Page 43
	[2ot] Switch operation (OUT2)	[2_P] Normal output	Page 43
	[P_2] Set value (OUT2)	50% of maximum rated flow [2.00] 2.00 L/min (4 L type) [8.0] 8.0 L/min (16 L type) [20.0] 20.0 L/min (40 L type) [50] 50 L/min (100 L type)	Page 43
	[H_2] Hysteresis (OUT2)	5% of maximum rated flow [0.20] 0.20 L/min (4 L type) [0.8] 0.8 L/min (16 L type) [2.0] 2.0 L/min (40 L type) [5] 5 L/min (100 L type)	Page 44
	[dtH2] Delay time setting at ON	[0.00] 0.00 s	Page 44
	[dtL2] Delay time setting at OFF	[0.00] 0.00 s	Page 47
	[CoL] Display colour (OUT2)	[1SoG] ON: Green, OFF: Red (OUT2)	Page 47
[F 2] *: When a temp. sensor is connected	[oUt2] Output mode (OUT2)	[tHYS] Temperature hysteresis	Page 43
	[2ot] Switch operation (OUT2)	[2_n] Reverse output	Page 43
	[tn_2] Set value (OUT2)	50% of maximum rated temp. [50] 50 °C (for all ranges)	Page 47
	[tH_2] Hysteresis (OUT2)	0% of maximum rated temp. [5] 5 °C (for all ranges)	Page 44
	[dtH2] Delay time setting at ON	[0.00] 0.00 s	Page 44
	[dtL2] Delay time setting at OFF	[0.00] 0.00 s	Page 44
[CoL] Display colour (OUT2)	[1SoG] ON: Green, OFF: Red (OUT2)	Page 47	
[F 3]	[FiL] Digital filter setting	[1.0] 1.0 s	Page 49
[F10]	[SUB] Sub screen display setting	[dEF] Standard (OUT1 set value displayed) *: When a temperature sensor is not connected. [dEF] Standard (fluid temp. displayed) *: When a temperature sensor is connected.	Page 50
[F30]	[SAve] Accumulated flow value storage	[oFF] Not saved	Page 56
[F80]	[diSP] Display OFF mode	[on] Normal display	Page 57
[F81]	[Pin] Security code setting	[oFF] OFF	Page 58
[F90]	[ALL] Setting of all functions	[oFF] OFF	Page 60
[F98]	[tEst] OUT1 output test mode	[n] Normal output	Page 61
[F99]	[ini] Reset to the default settings	[oFF] OFF	Page 64

■[F 0] Display units and switch output specifications

This setting is only available for models with the units selection function.

<Operation>

Press the UP or DOWN button in function selection mode to display [F 0].

Press the SET button. ↓ Move on to display unit setting.

Display unit setting

Press the UP or DOWN button to select the display unit.

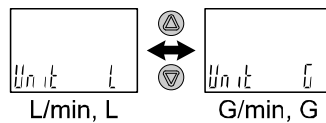
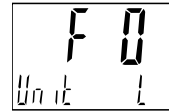

*: A product with no units selection function (fixed to SI units) does not indicate the display unit [G].

Press the SET button to set. ↓ Move on to the switch output NPN/PNP specification switching setting.

Switching setting of switch output NPN/PNP specifications

The switch output of this product can be switched to NPN or PNP output in accordance with the user device construction.

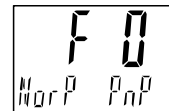

Press the UP or DOWN button to select switch output specification.

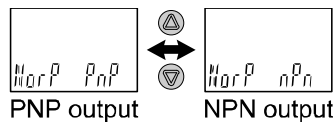

Press the SET button to set. ↓ Return to function selection mode.

[F 0] Setting of the display units and switch output specifications is completed.

■[F 1] Setting of OUT1

The output mode of OUT1 can be selected.

<Flowchart of functions>

1. Selection of output mode

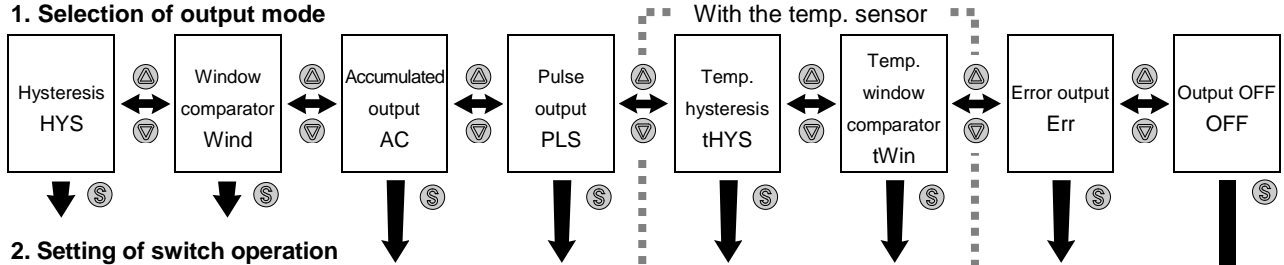

2. Setting of switch operation

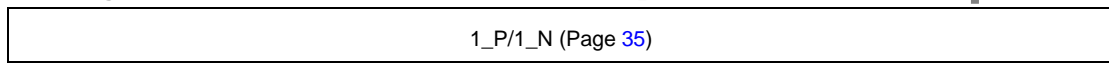

3. Input of set values

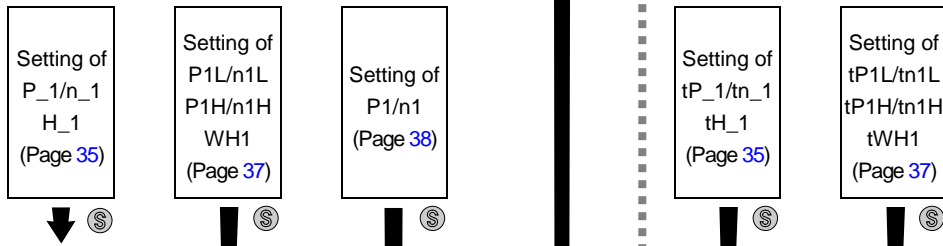

4. Delay time

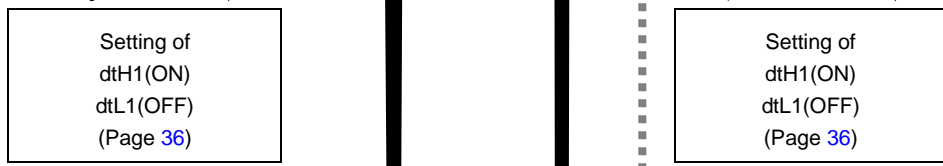

5. Selection of display colour

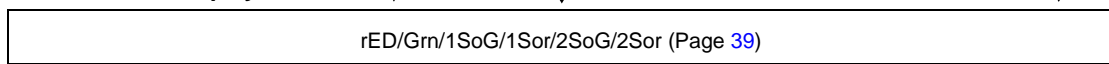

6. Completed

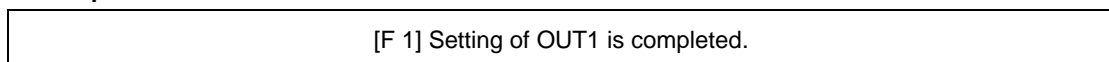

<Operation>

Press the UP or SET button in function selection mode to display [F 1].

Press the SET button. ↓ Move on to output mode setting.

Output mode setting

Press the UP or DOWN button to select the output mode.

*: When the accumulated pulse output is selected, the output display (Indicator LED) will turn off.

Press the SET button to set. ↓ Move on to the setting of switch operation.

Setting of switch operation

Press the UP or DOWN button to select the switch operation.

Normal output Reversed output

*: By switching the output, the display colour will change in relation to the setting.

Press the SET button to set. ↓ Move on to the input of set values.

Input of set values

a, (Temperature) When hysteresis output mode is selected

The sub screen (right side) displays the set value.
Change it with the UP and DOWN buttons.
(When reversed output is selected, the sub screen (left side) displays [n_1].)
(For an output related to a temperature sensor, the left side of the sub screen displays [t*_1] *: P/n)

Press the SET button to set. ↓ Move on to the setting of hysteresis.



Hysteresis setting



The sub screen (right side) displays the hysteresis value.
Change it with the UP and DOWN buttons.
(For an output related to a temperature sensor, the left side of the sub screen displays [tH_1].)

* : The set value and hysteresis range will be limited depending on the values.

Press the SET button to set. ↓ Move on to delay time setting.

Delay time setting



The sub screen (right side) displays the delay time value.
Change it with the UP and DOWN buttons.
Press the SET button to set the OFF delay time [dtL1] after setting the ON delay time [dtH1].

Press the SET button to set. ↓
Move on to display colour setting. (Page 39)

Input of set values

b. (Temperature) When window comparator output mode is selected.

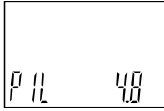

The sub screen (right side) displays the set value.
Change it with the UP and DOWN buttons.
(When reversed output is selected, the sub screen (left side) displays [n1L].)
(For an output related to a temperature sensor, the left side of the sub screen displays [t*1L] *: P/n)

Press the SET button to set. ↓ Move to the input of the [P1H] set value.

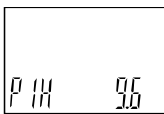

The sub screen (right side) displays the hysteresis value.
Change it with the UP and DOWN buttons.
(When reversed output is selected, the sub screen (left side) displays [n1H].)
(For an output related to a temperature sensor, the left side of the sub screen displays [t*1H] *: P/n)

Press the SET button to set. ↓ Move on to the setting of hysteresis.

Hysteresis setting

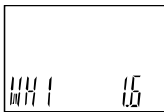

The sub screen (right side) displays the hysteresis value.
Change it with the UP and DOWN buttons.
(For an output related to a temperature sensor, the left side of the sub screen displays [tWH1].)

Press the SET button to set. ↓ Move on to delay time setting.

Delay time setting

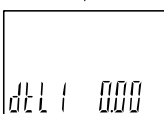
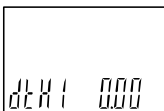

The sub screen (right side) displays the delay time value.
Change it with the UP and DOWN buttons.
Press the SET button to set the OFF delay time [dtL1] after setting the ON delay time [dtH1].

Press the SET button to set. ↓

Move on to display colour setting. (Page 39)

Input of set values

c. When accumulated output mode is selected.

Selection of accumulated increment or decrement.
Press the UP or DOWN button to select.

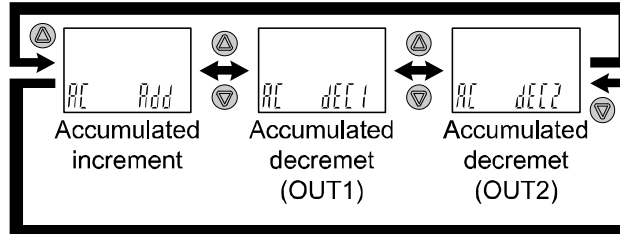
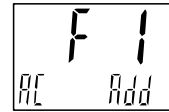

Press the SET button to set. ↓ Move on to the input of set values.



The sub screen (right side) displays the set value.
Change it with the UP and DOWN buttons.

*: When setting the accumulated flow value, the accumulated conversion factor should be the same as in [F 0].

Press the SET button to set. ↓
Move on to display colour setting. (Page 39)

●Setting range of the accumulated flow output

The accumulated output setting range is displayed by the set value of the 4 digits and the units.

Set the value by key operation in the sub display. The upper 4 digits of the value is displayed by shifting of the digit. Refer to the table below for details of the set value and display.

Accumulated minimum unit: 0.1 L

Key operation	Set accumulated value	Sub screen display	
		Value	Units indication
△	0.0	0.0	L
↓	to	to	
	1,000.0	1.000	x10 ³ L
	to	to	
	9,999.0	9.999	x10 ³ L
	to	to	
•	99,990.0	99.99	x10 ³ L
•	to	to	
•	1,000,000.0	1.000	x10 ⁶ L
	to	to	
	10,000,000.0	10.00	x10 ⁶ L
	to	to	
	99,990,000.0	99.99	x10 ⁶ L
↑	to	to	
▽	999,900,000.0	999.9	x10 ⁶ L

Accumulated minimum unit: 1 L

Key operation	Set accumulated value	Sub screen display	
		Value	Units indication
△	0	0	L
↓	to	to	
	1.000	1.000	x10 ³ L
	to	to	
	9.999	9.999	x10 ³ L
	to	to	
•	99.990	99.99	x10 ³ L
•	to	to	
•	1,000,000	1.000	x10 ⁶ L
	to	to	
	10,000,000	10.00	x10 ⁶ L
	to	to	
	99,990,000	99.99	x10 ⁶ L
↑	to	to	
▽	9,999,000,000	9999	x10 ⁶ L

*: The units on the right side of the sub screen will flash.

*: When the units are set to [G] with [F 0], the units display "L" will be turned OFF. (OFF = Units G will be displayed).

Selection of display colour

The display colour (main screen) can be selected depending on the switch output condition.

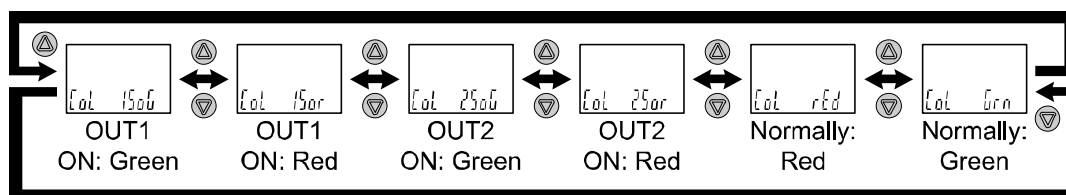
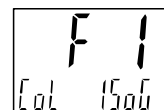

Press the SET button to set. ↓ Return to function selection mode.

[F 1] Setting of OUT1 is completed.

*1: Selected item becomes valid after pressing the SET button.

*2: After enabling the setting by pressing the SET button, it is possible to return to the measurement mode by keeping pressing the SET button for 2 seconds or longer.

oList of output modes

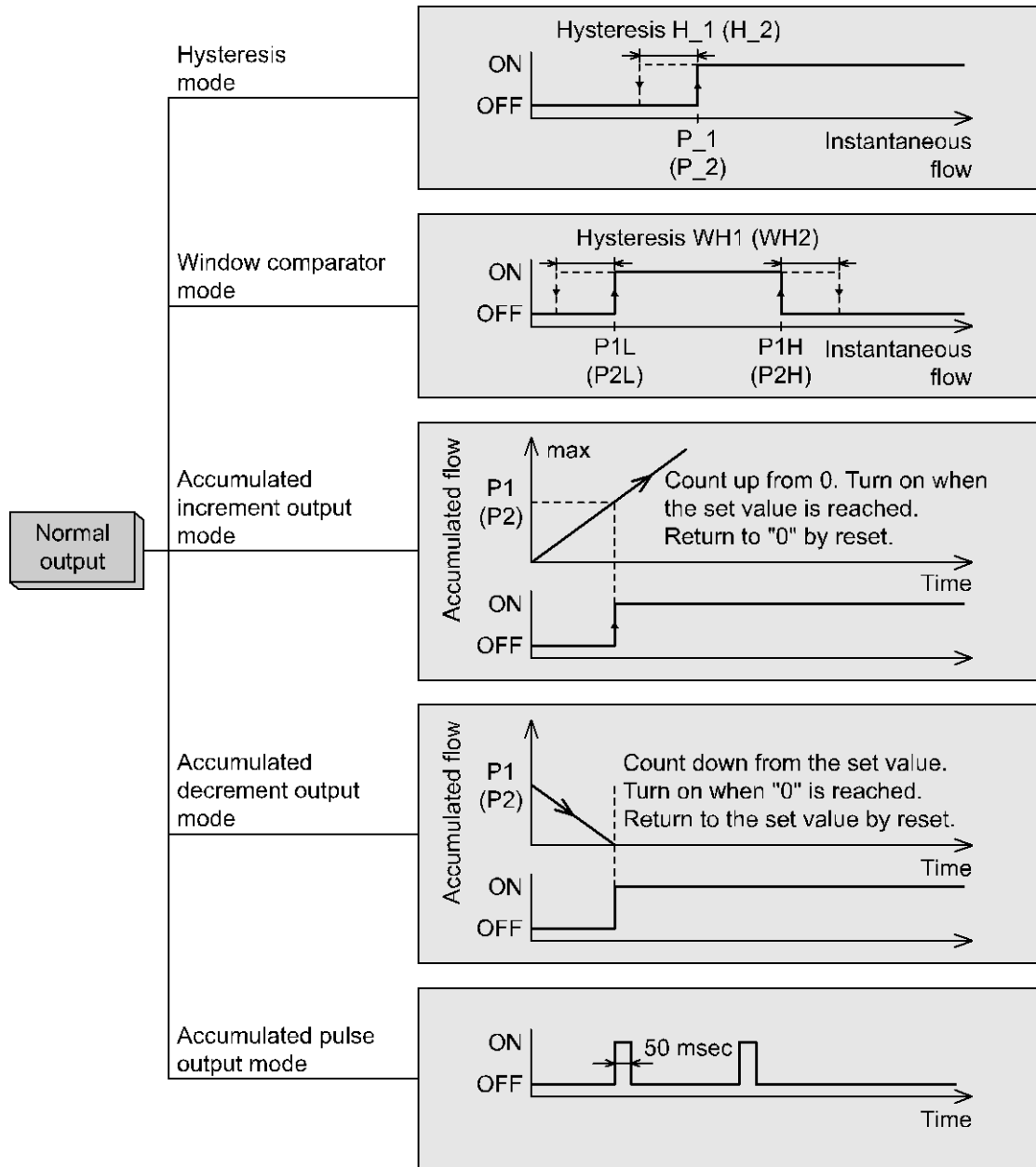

*: If hysteresis or window comparator mode is selected and there is an unstable flow condition (due to fluid pulsation, for example), unstable output operation can result.

In such situations, keep sufficient margin between the set values and confirm that the output operation stabilizes.

*: When the accumulated pulse output is selected, the output display will turn off.

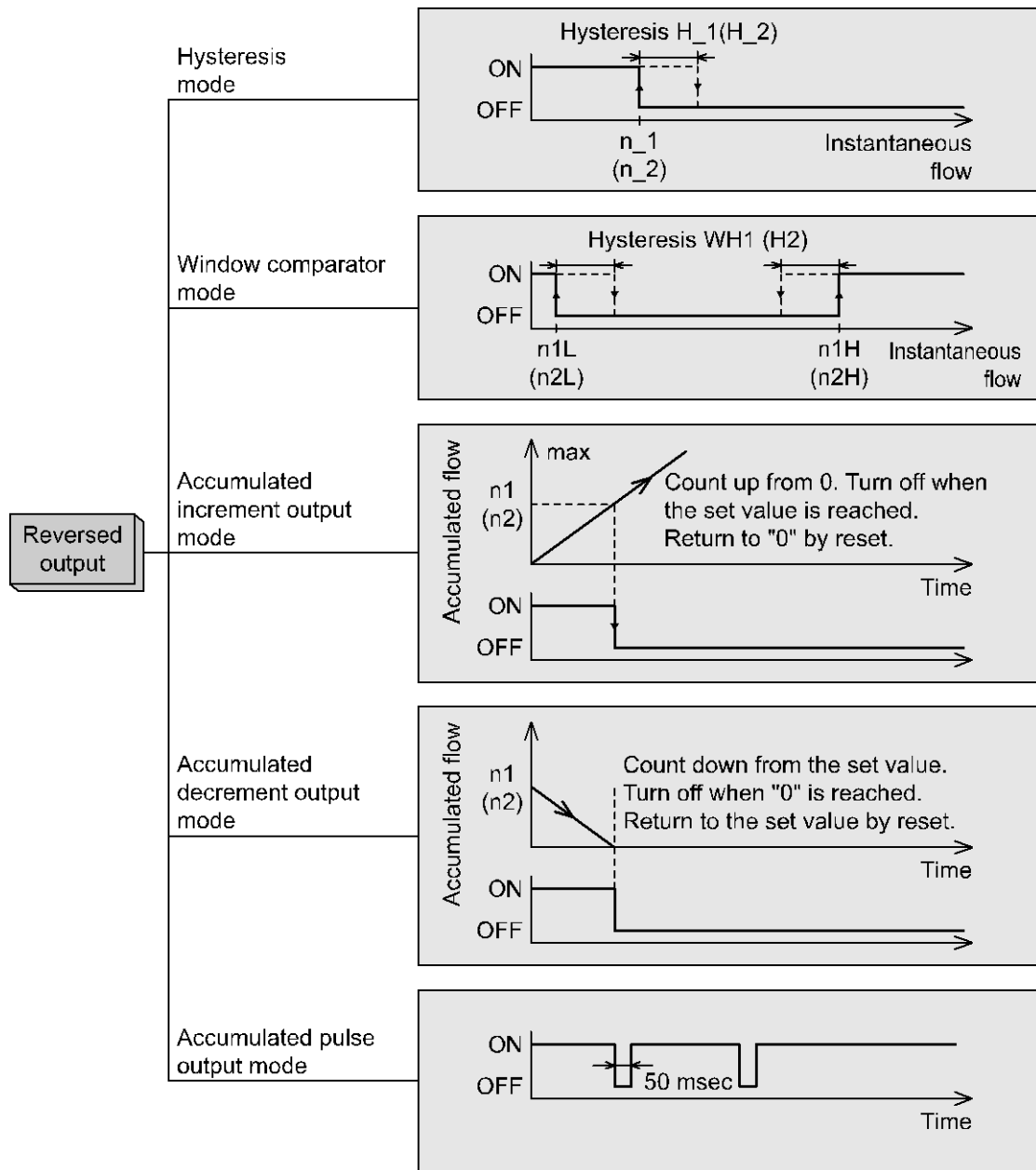

*: If hysteresis or window comparator mode is selected and there is an unstable flow condition (due to fluid pulsation, for example), unstable output operation can result.

In such situations, keep sufficient margin between the set values and confirm that the output operation stabilizes.

*: When the accumulated pulse output is selected, the output display will turn off.

■[F 2] Setting of OUT2

The output mode of OUT2 can be selected.

<Flowchart of functions>

1. Selection of output mode

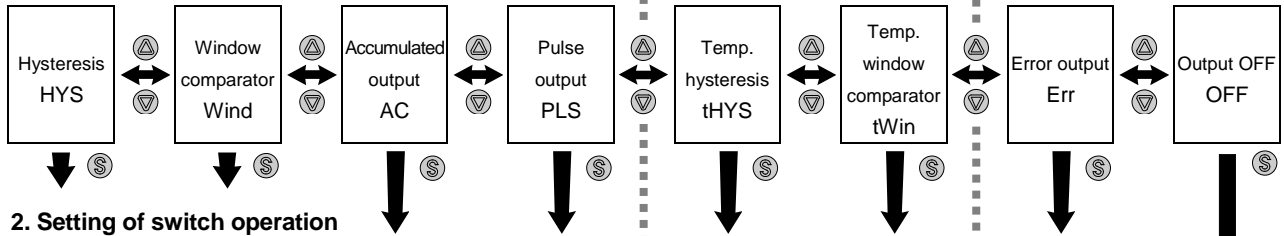

2. Setting of switch operation

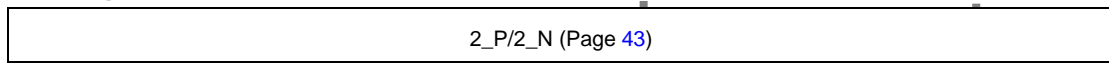

3. Input of set values

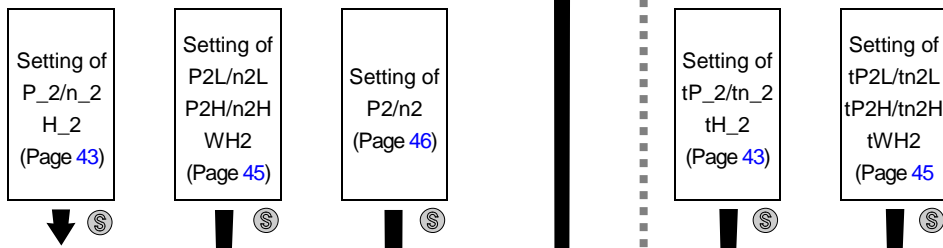

4. Delay time

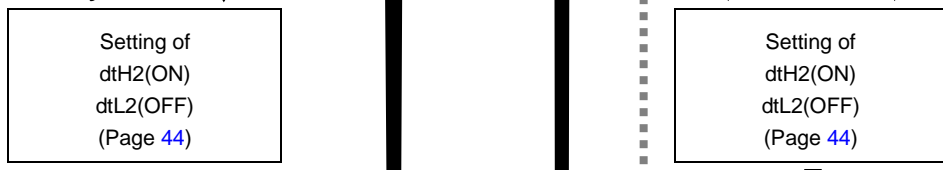

5. Selection of display colour

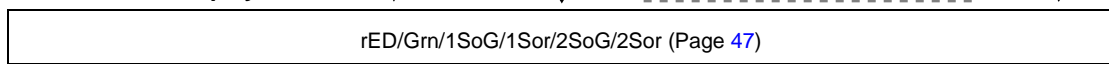

6. Completed

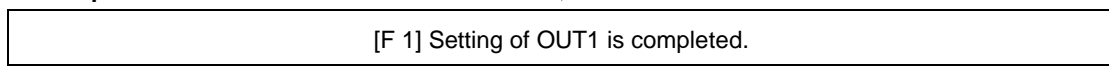

<Operation>

Press the UP or SET button in function selection mode to display [F 2].

Press the SET button. ↓ Move on to output mode setting.

Output mode setting

Press the UP or DOWN button to select the output mode.

*: When the accumulated pulse output is selected, the output display (Indicator LED) will turn off.

Press the SET button to set. ↓ Move on to the setting of switch operation.

Setting of switch operation

Press the UP or DOWN button to select the switch operation.

*: By switching the output, the display colour will change in relation to the setting.

Press the SET button to set. ↓ Move on to the input of set values.

Input of set values

a, (Temperature) When hysteresis output mode is selected

The sub screen (right side) displays the set value.
Change it with the UP and DOWN buttons.
(When reversed output is selected, the sub screen (left side) displays [n_2].)
(For an output related to a temperature sensor, the left side of the sub screen displays [t*_2] *: P/n)

Press the SET button to set. ↓ Move on to the setting of hysteresis.



Hysteresis setting



The sub screen (right side) displays the hysteresis value.
Change it with the UP and DOWN buttons.
(For an output related to a temperature sensor, the left side of the sub screen displays [tH_2].)

*: The set value and hysteresis range will be limited depending on the values.

Press the SET button to set. ↓ Move on to delay time setting.

Delay time setting

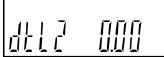
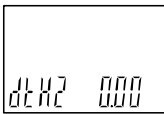

The sub screen (right side) displays the delay time value.
Change it with the UP and DOWN buttons.
Press the SET button to set the OFF delay time [dtL1] after setting the ON delay time [dtH1].

Press the SET button to set. ↓
Move on to display colour setting. (Page 47)

Input of set values

b. (Temperature) When window comparator output mode is selected.

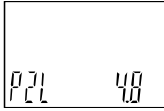

The sub screen (right side) displays the set value.
Change it with the UP and DOWN buttons.
(When reversed output is selected, the sub screen (left side) displays [n2L].)
(For an output related to a temperature sensor, the left side of the sub screen displays [t*2L] *: P/n)

Press the SET button to set. ↓ Move to the input of the [P1H] set value.

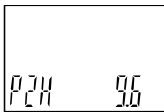

The sub screen (right side) displays the hysteresis value.
Change it with the UP and DOWN buttons.
(When reversed output is selected, the sub screen (left side) displays [n2H].)
(For an output related to a temperature sensor, the left side of the sub screen displays [t*2H] *: P/n)

Press the SET button to set. ↓ Move on to the setting of hysteresis.

Hysteresis setting

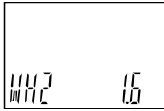

The sub screen (right side) displays the hysteresis value.
Change it with the UP and DOWN buttons.
(For an output related to a temperature sensor, the left side of the sub screen displays [tWH2])

Press the SET button to set. ↓ Move on to delay time setting.

Delay time setting

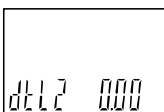
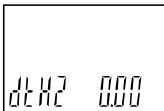

The sub screen (right side) displays the delay time value.
Change it with the UP and DOWN buttons.
Press the SET button to set the OFF delay time [dtL1] after setting the ON delay time [dtH1].

Press the SET button to set. ↓

Move on to display colour setting. (Page 47)

Input of set values

c. When accumulated output mode is selected.

Selection of accumulated increment or decrement.
Press the UP or DOWN button to select.

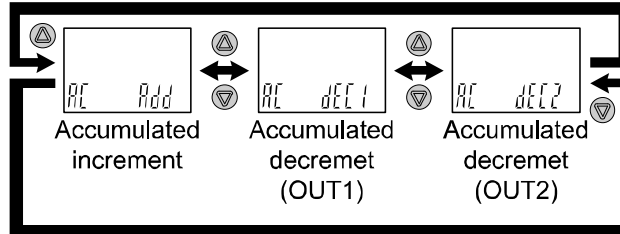
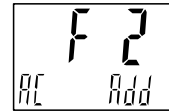

Press the SET button to set. ↓ Move on to the input of set values.

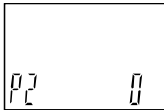

The sub screen (right side) displays the set value.
Change it with the UP and DOWN buttons.

*: When setting the accumulated flow value, the accumulated conversion factor
should be the same as in [F 0].

Press the SET button to set. ↓
Move on to display colour setting. (Page 47)

Selection of display colour

The display colour (main screen) can be selected depending on the switch output condition.

*: The display colour setting is linked to the [F 1] OUT1 setting.

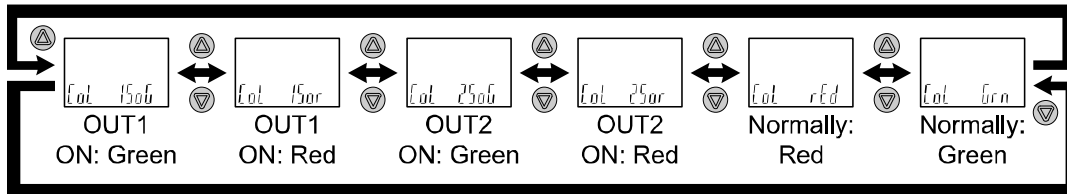

Press the SET button to set. ↓ Return to function selection mode.

[F 2] Setting of OUT1 is completed.

*1: Selected item becomes valid after pressing the SET button.

*2: After enabling the setting by pressing the SET button, it is possible to return to the measurement mode by keeping pressing the SET button for 2 seconds or longer.

oList of output modes for fluid temperature

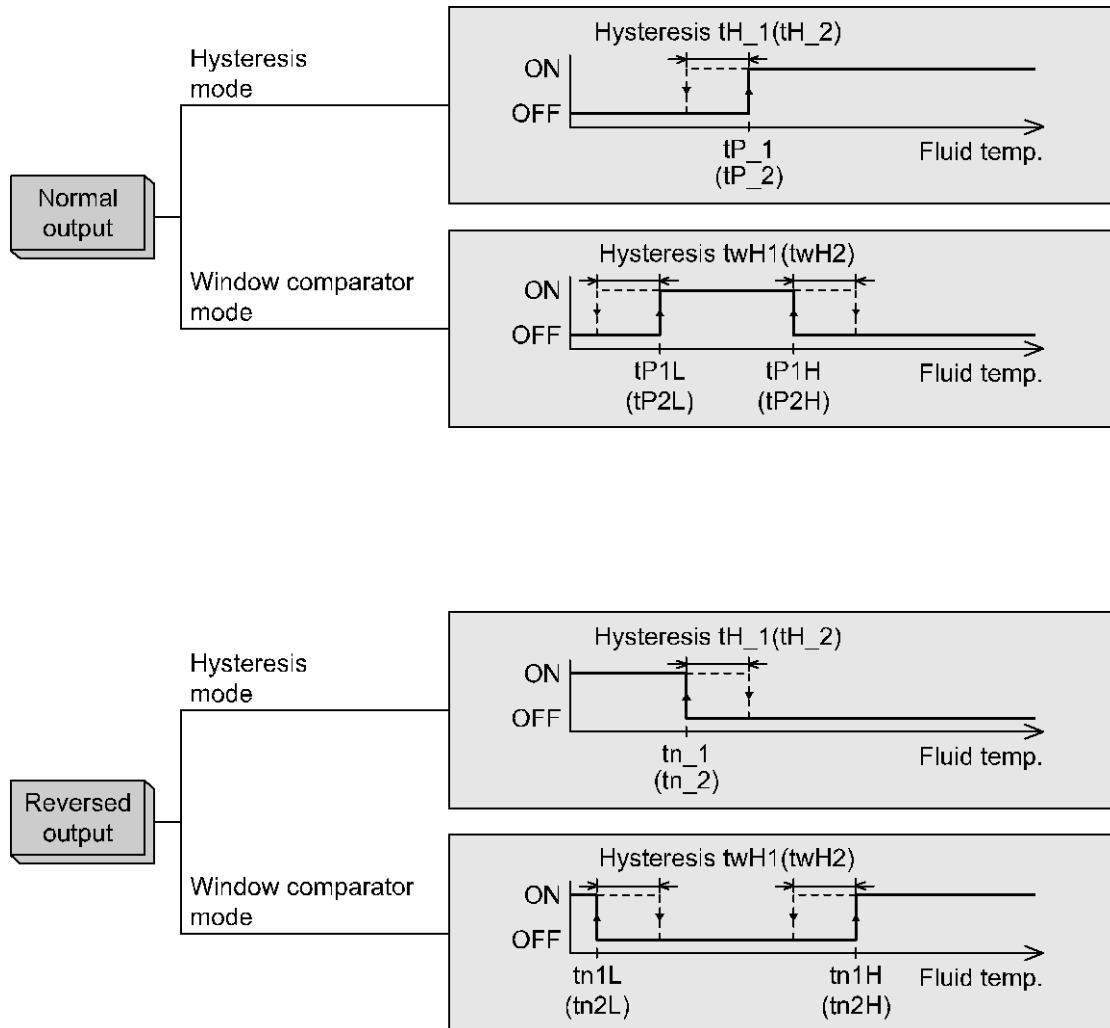

■[F 3] Digital filter setting

Set the digital filter.

Output chattering or flicker in the measurement mode display can be reduced by setting the digital filter.

<Operation>

Press the UP or DOWN button in function selection mode to display [F 3].

Press the SET button. ↓ Move on to digital filter setting.

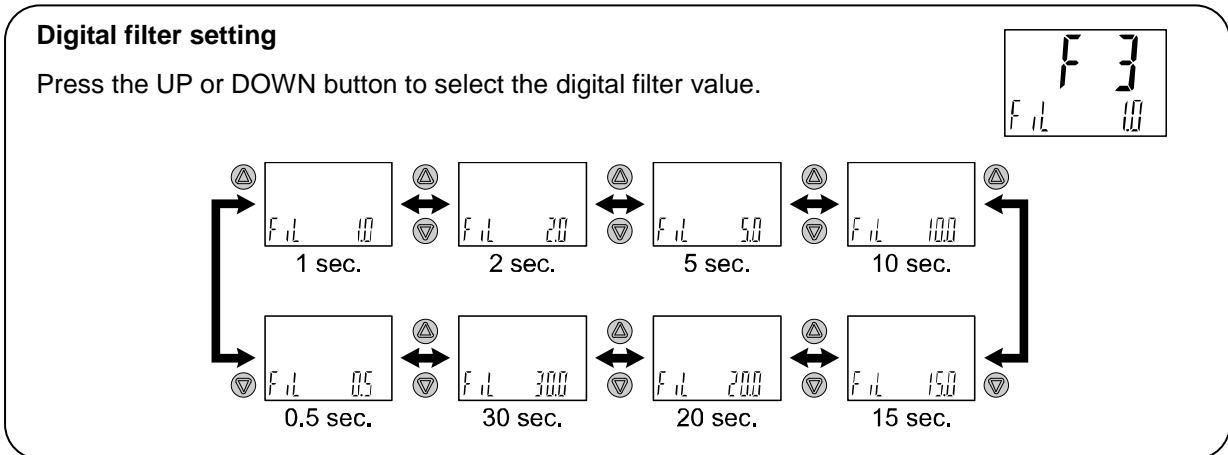

Press the SET button to set. ↓ Return to the function selection mode.

[F 3] Response time setting is completed.

*1: Each set value is a guideline for 90% response time.

*2: Both the switch output and flow display are affected. When only switch output needs to be affected, select the delay time setting. (Page 36)

*3: The response time of the temperature sensor is set about 7 seconds and no connection with this setting value.

■[F10] Sub screen setting

Set the sub screen display.

Detailed contents are shown in the pages from 51.

<Operation>

Press the UP or DOWN button in function selection mode to display [F10].

Press the SET button. ↓ Move on to sub screen setting.

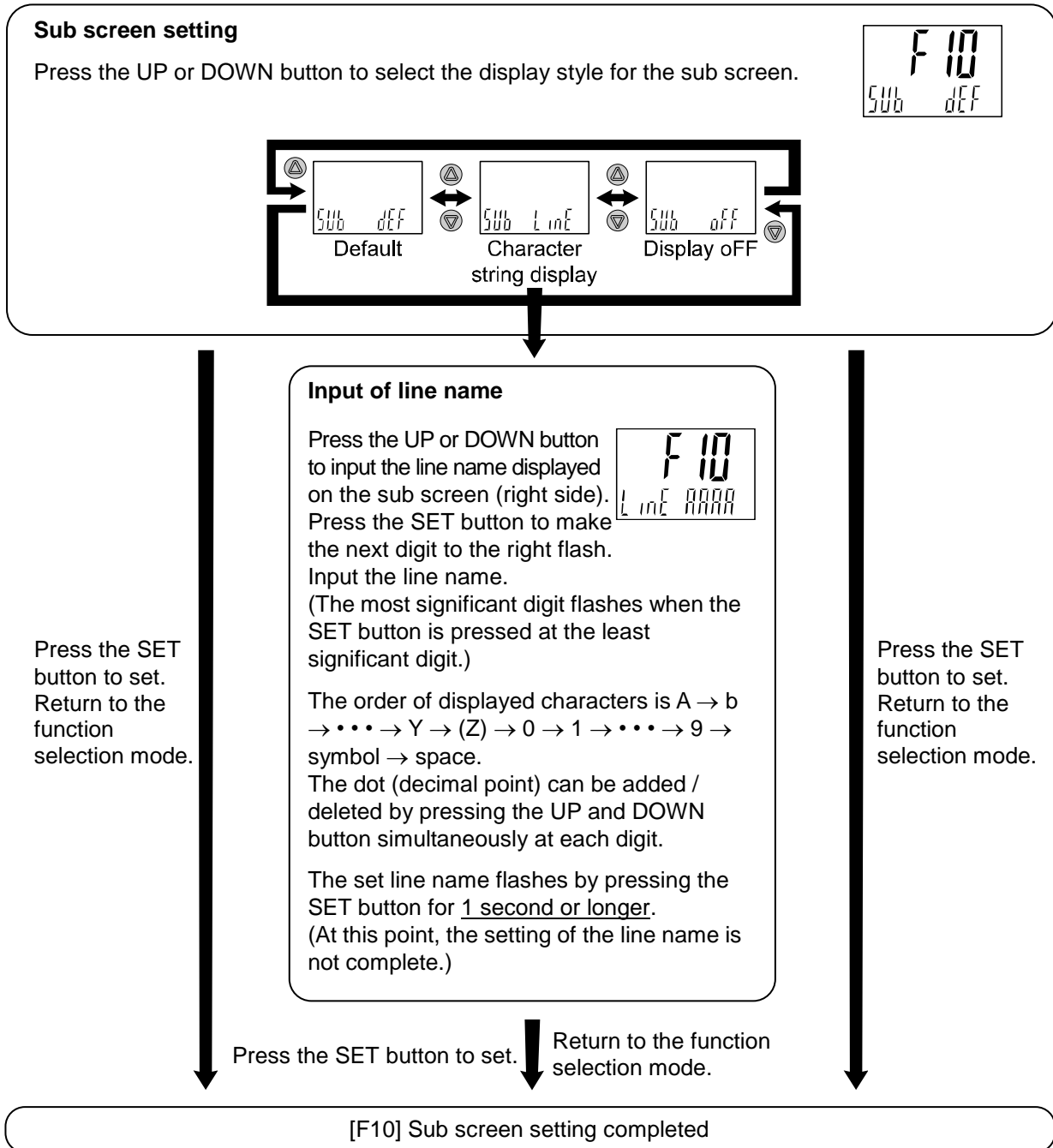

<Sub screen display>

The following display items and values can be displayed on the sub screen.

The displayed item varies depending on the setting of the output mode. Select the displayed items by pressing the UP or DOWN button in measurement mode.

*: Sub screen display (for 16 L range)

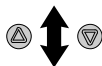
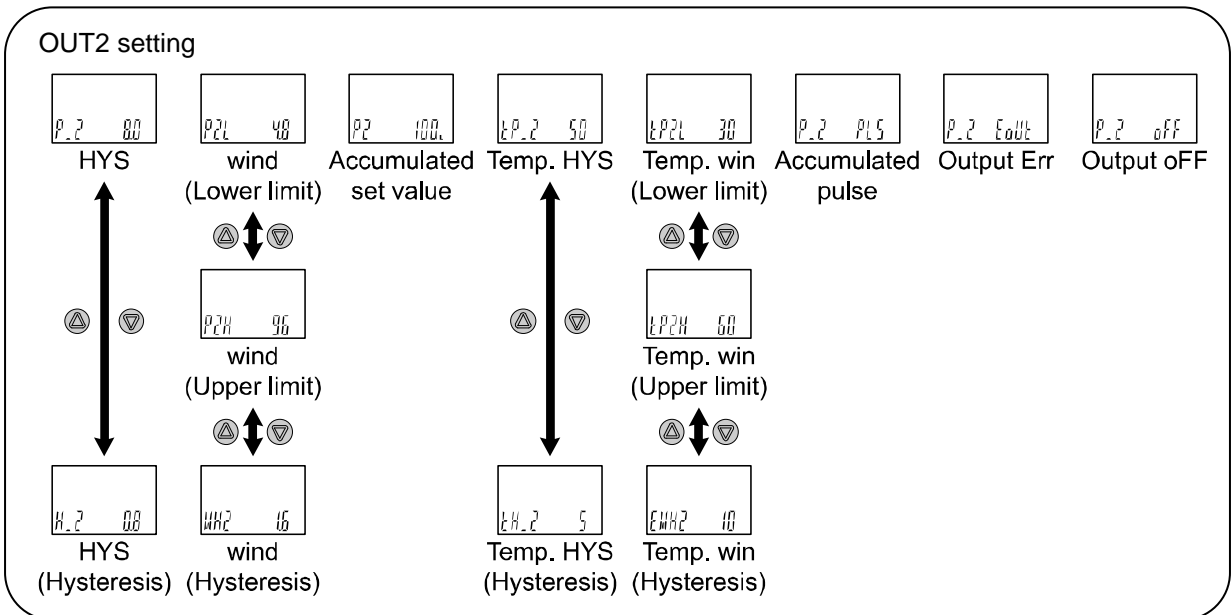
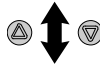
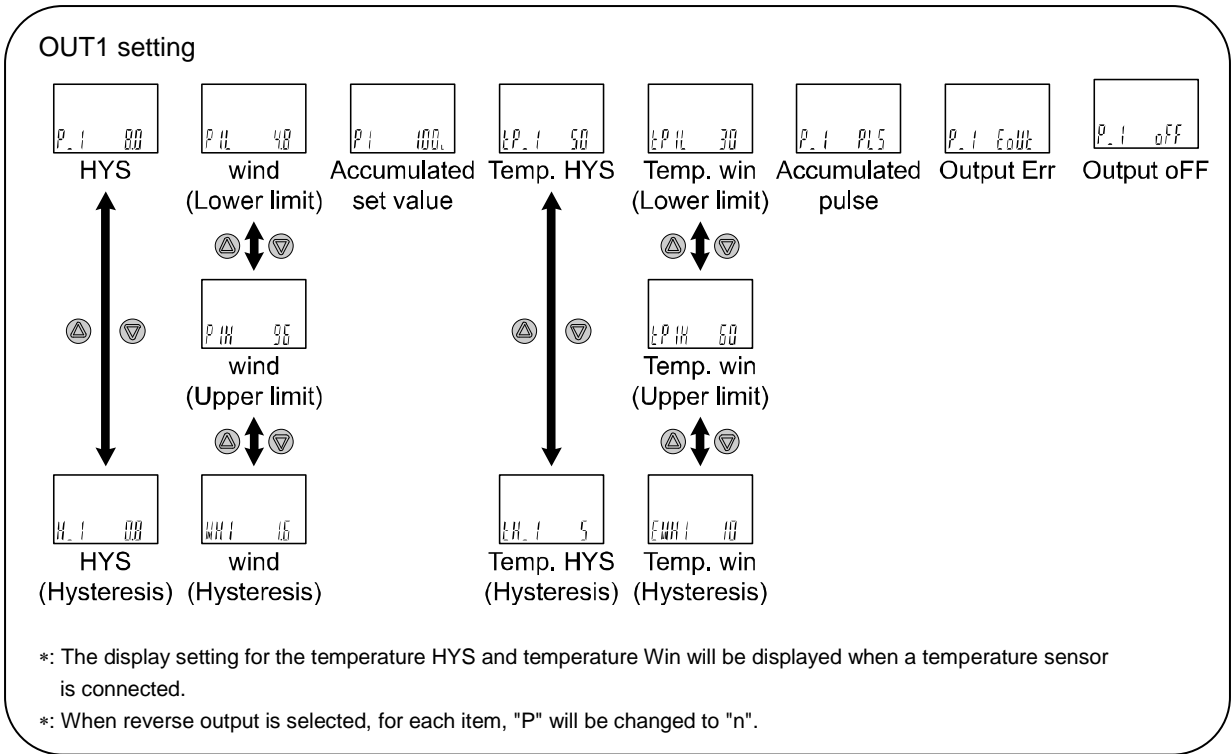

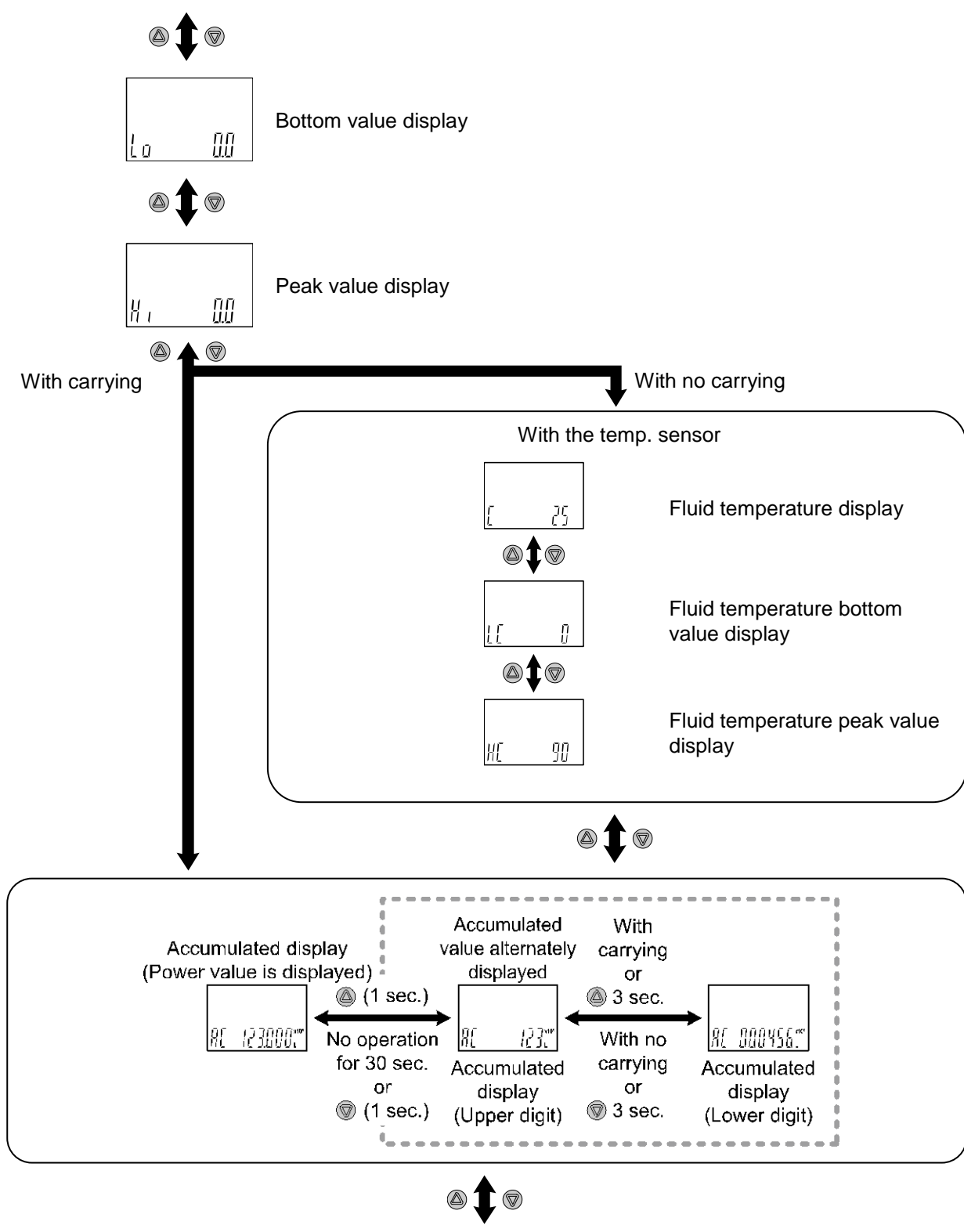

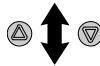

Switch output/communication mode display

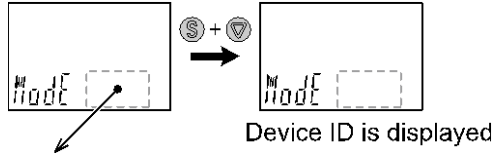

Item	Content	Condition
Sio	SIO mode	SIO mode or WakeUp
Strt	StartUp mode	StartUp
PrE	PreOperate mode	Pre Operate
oPE	Operate mode	Operate
LoC	Data storage LOC mode	Data storage LOC and SIO mode



When the setting of [F10] is other than [dEF]

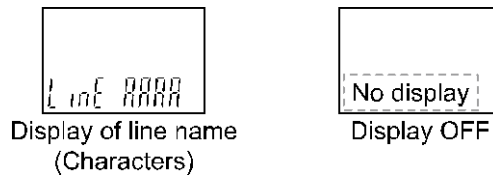

OUT1 setting

•(Temperature) Peak/Bottom value

The maximum flow/temperature (peak) and minimum flow/temperature (bottom) flow from when the power is supplied to this moment is detected and updated.

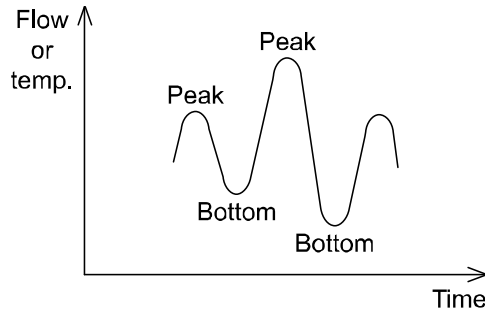

Peak and bottom values can be reset by pressing the SET and DOWN buttons simultaneously for 1 second.

•Display of line name (Character string)

The line name on which the flow switch is used can be displayed. (Max. 4 letters)

When line name is input, characters which can be displayed for each digit are as follows.

A	B	C	D	E	F	G	H	I	J	K	L	M	N	O	P	Q	R	S	T	U	V	W	X	Y	Z
À	Á	Â	Ã	Ä	Å	Æ	Ç	È	É	Ê	Ë	Ì	Í	Î	Ï	Ð	Ñ	Ò	Ó	Ô	Õ	Ö	×	Ý	ÿ
0	1	2	3	4	5	6	7	8	9	Symbol		K	M	N	R	V	W				Space		(Dot)		
0	1	2	3	4	5	6	7	8	9	_	-	!	#	¥	¤	¢	£	u	ü					.	

A dot (.) is displayed only for the first, second or third digit from the left. It is possible to add or delete the dot by pressing the UP and DOWN buttons simultaneously.

•Fluid temperature display

When a temperature sensor is connected, the fluid temperature can be displayed.

C displayed on the left side indicates centigrade (°C).

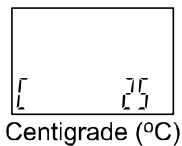

•Display OFF mode

The sub screen remains OFF.

•Display of accumulated value

The power display (Value $\times 10^{\text{Nth}}$ power) and upper digit - lower digit are displayed alternately.

The sub screen always displays power.

When the DOWN button is pressed for 1 second on the accumulated value display screen, the display will be switched alternately.

Power display: The effective upper 4 digits of the accumulated measurement value are displayed.

The dot (decimal point) and units display indicator ($\times 10^3/\times 10^6$) light up due to carrying of the digits.

Alternate display: The accumulated flow measurement value is displayed in two parts, upper digits (7th to 10th digit) and lower digits (1st to 6th digit).

The values are displayed with the lower digits until it exceeds the 6th digit.

When the value exceeds the 6th digit, "Upper digits (3 seconds) \leftrightarrow lower digits (3 seconds)" will be displayed alternately.

*: Accumulated value display example (in case of 16 L range)

Accumulated value	Power value is displayed	Alternate display	
		Upper digits	Lower digits
123.4 L		No display (only lower digits are displayed).	
123,456.7 L			
12,345,678.9 L			
999,999,999.9 L (maximum accumulated flow value exceeded)			No display (upper digits flashing display)

(1 sec.) \leftrightarrow No operation for 30 sec. or (1 sec.)

■ [F30] Accumulated flow value hold setting

Select the setting in which the accumulated flow measurement value is stored to the internal memory.

The default setting is not to store the accumulated flow when the power supply is turned off.

This function enables the accumulated flow value to be stored in permanent memory every 2 or 5 minutes.

The internal memory life varies depending on the number of times that the memory device can be accessed, so this must be taken into account before use.

If the product is operated 24 hours per day, the maximum writable limit will be as follows:

Data memorized every 5 minutes --- 5 minutes x the number of times the memory device can be accessed (3.7 million cycles) = 1850 million minutes = Approx. 35 years

Data memorized every 2 minutes --- 2 minutes x the number of times the memory device can be accessed (3.7 million cycles) = 740 million minutes = Approx. 14 years

<Operation>

Press the UP or DOWN button in function selection mode to display [F30].

Press the SET button. ↓ Move to the accumulated flow value hold setting.

Accumulated flow value hold setting

Select the accumulated flow value hold setting by pressing the UP or DOWN button.



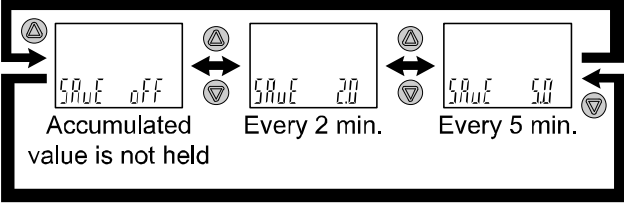

Press the SET button to set. ↓ Return to function selection mode.

[F30] Accumulated value hold setting is completed.

*: Data memorization is performed every 2 or 5 minutes (depending upon the setting chosen), this means that the accumulated flow value for up to 2 or 5 minutes before the power supply is turned off will not be added to the device memory.

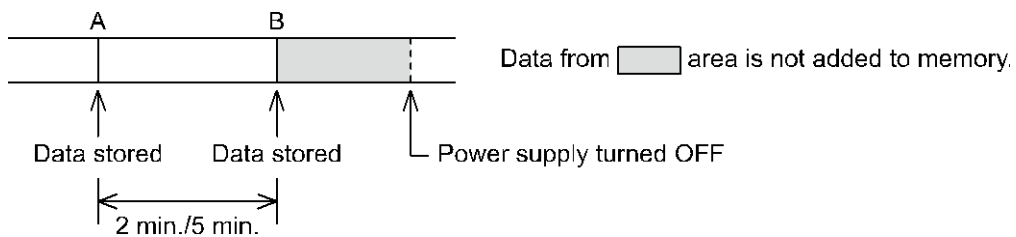

When the power supply is turned on again, the accumulated flow count will start from the value recorded at B.

■[F80] Display OFF mode setting

Select the display ON/OFF mode.

With this function, the display will change to OFF mode when no button operations are performed for 30 seconds.

During the display OFF mode operation, the under bars on the right side of the sub screen will flash for 3 digits.

In the default setting, power saving mode is OFF (normal mode).

<Operation>

Press the UP or DOWN button in function selection mode to display [F80].

Press the SET button. ↓ Move to the display OFF mode setting.

Display OFF mode setting

Select the display OFF mode setting by pressing the UP and DOWN buttons.

d 1.5P on



d 1.5P off



Press the SET button to set. ↓ Return to function selection mode.

[F30] Accumulated flow value hold setting is completed.

With the display OFF mode, when a button operation is performed, normal operation is resumed. When a button operation is not performed for 30 seconds, the display will return to the display OFF mode (only for measurement mode).

The display during the display OFF mode will be as follows.

- Main screen: OFF
- Sub screen (left side): OFF
- Sub screen (right side): Under bars (—) for 3 digits will flash.
- Unit display LED: OFF
- Indicator LED: Flashes according to the switch operation status
- Communication indicator LED: Flashes according to the communication status (IO/Link mode)



Switch ON



Switch OFF



IO-Link mode

■[F81] Setting of security code

The Security code can be changed during key lock mode.

<Operation>

Press the UP or DOWN button in function selection mode to display [F81].

Press the SET button. ↓ Move on to security code.

Security code

Press the UP or DOWN button to select the setting of security code.

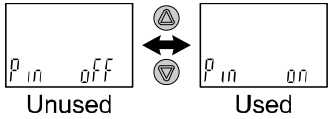

Press the SET button to set. ↓ Move on to security code checking.

[oFF] (Unused) is selected.
Press the SET button to return to function selection mode.

Security code checking

Press the UP or DOWN button to input the security code on the sub screen (right side).
(The default setting is [000].) *

For instructions on how to enter the security code, refer to "How to input and change the security code" on page 68.

If the security code entered is incorrect, [FAL] will be displayed, and the security code must be entered again.
If the wrong security code is entered 3 times, [nG] is displayed and the device returns to function selection mode.



Press the SET button for 1 second to set. ↓ Move on to security code changing.

Security code changing

Press the UP or DOWN button to input the changed security code on the main screen. *
For instructions on how to enter the security code, refer to "How to input and change the security code" on page 68.



After entry, the changed security code will flash by pressing the SET button for 1 second.
(At this point, the changing of the security code is not completed)
Return to the change of setting again by pressing the UP or DOWN button.



Press the SET button to set. ↓ Return to function selection mode.

[F81] Security code completed.

If the security code function is enabled, it is will be necessary to input a security code to release the key-lock.

*: If a key is not pressed for 30 seconds while entering the security code, function selection mode will return.

■[F90] Setting of all functions

All functions can be set one after the other, without having to select each one separately from the function selection mode.

<Operation>

Press the UP or DOWN button in function selection mode to display [F90].

Press the SET button. ↓ Move on to setting of all functions.

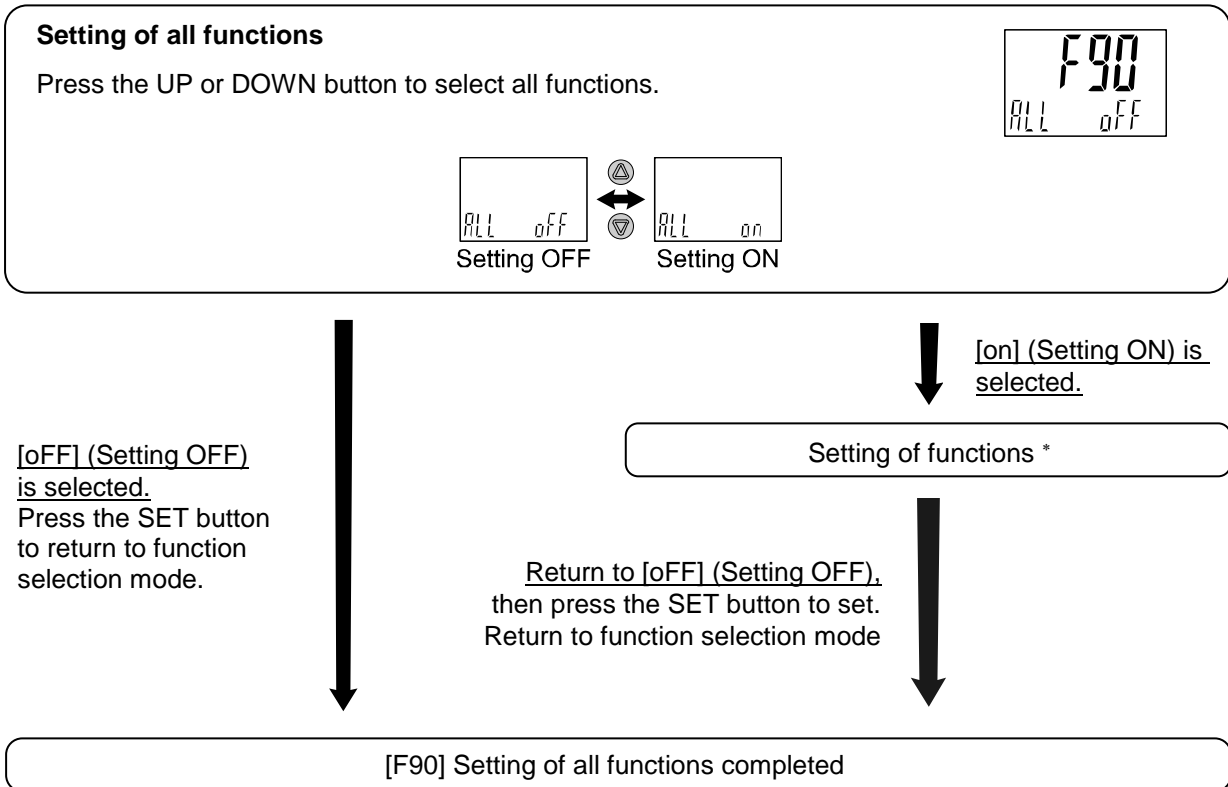

*: Setting of each function

Every time the SET button is pressed, the display moves to the next function in order of "Setting of each function" on table below. The setting method depends on the setting of each function.

*: Measurement mode can be returned from any setting items by pressing and holding the SET button for 2 seconds or longer.

*: The function setting from before returning to the measurement mode is maintained.

●Setting of each function

Order	Function	Item
1	F 0	Display unit and switch output specifications
2	F 1	Setting of OUT1
3	F 2	Setting of OUT2
4	F 3	Digital filter setting
5	F10	Sun display setting
6	F30	Accumulated flow value hold setting
7	F80	Display OFF mode setting
8	F81	Setting of security code

■[F98] Output check

The output operation can be forcibly checked.
The output can be turned ON/OFF manually.

<Operation>

Press the UP or DOWN button in function selection mode to display [F98].

Press the SET button. ↓ Move on to output check.

Output check

Press the UP or DOWN button to select output check.



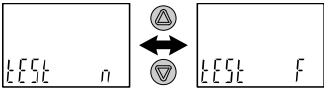

Normal output Forcibly output

↓ [F] (Forced output) is selected.
Press the SET button to set.

[n] (Normal output) is selected.
 Press the SET button to set.
 Return to function selection mode.

OUT1 output check

Press the UP or DOWN button to select OUT1 output check.

*: The output status (ON/OFF) immediately before this display will be the initial value.



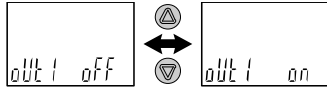

Forcibly OFF Forcibly ON

Press the SET button to set. ↓

OUT1 output check

Press the UP or DOWN button to select OUT1 output check.

*: The output status (ON/OFF) immediately before this display will be the initial value.



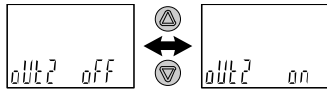

Forcibly OFF Forcibly ON

Press the SET button to set. ↓

↓

PD diagnostic bit (flow) check

Select the diagnostic bit (flow) check by pressing the UP or DOWN button.

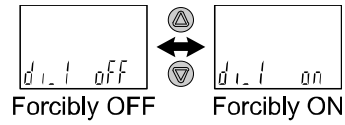

*: This function is available with IO-Link communication.

*: Refer to page 77 for details of the diagnostic information.

Press the SET button to set. ↓

PD diagnostic bit (temperature) check

Select the diagnostic bit (temperature) check by pressing the UP or DOWN button.

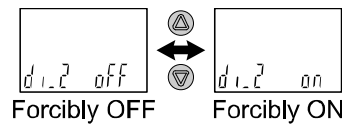

*: This function is available with IO-Link communication.

*: Refer to page 77 for details of the diagnostic information.

Press the SET button to set. ↓

PD diagnostic bit (error) check

Select the diagnostic bit (error) check by pressing the UP and DOWN button.

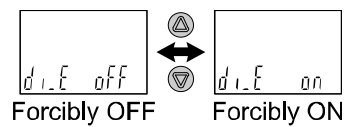
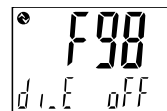

*: This function is available with IO-Link communication.

*: Refer to page 77 for details of the diagnostic information.

Press the SET button to set. ↓

↓

PD (process data) flow measurement check

The upper and lower limit flow measurement values can be output as the PD (process data) measurement value. Select the upper and lower values by pressing the UP or DOWN button.

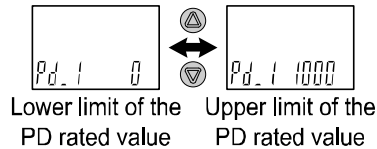

- *: This function is available with IO-Link communication.
- *: Refer to page 71 for details of the PD measurement value.

Press the SET button to set. ↓

PD (process data) temperature measurement check

The upper and lower limit temperature measurement values can be output as the PD (process data) measurement value. Select the upper and lower values by pressing the UP or DOWN button.

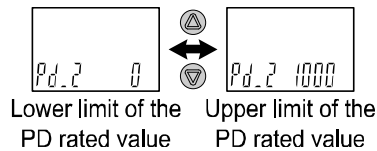
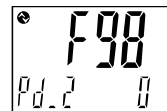

- *: This function is available with IO-Link communication.
- *: Refer to page 71 for details of the PD measurement value.

Press the SET button to return to [n] (Normal output), then press the SET button to set. Return to function selection mode.

↓

[F98] Output check completed.

*: Measurement mode can return from any setting item by pressing the SET button for 2 seconds or longer.

*: Even though the flow/temperature increases or decreases during the output check, the normal output operation will not function.

■[F99] Reset to default settings

If the product settings are uncertain, the default values can be restored.

<Operation>

Press the UP or DOWN button in function selection mode to display [F99].

Press the SET button. ↓ Move on to reset to default settings.

Reset to default settings

Press the UP or DOWN button to display [ON], then press the SET and DOWN buttons simultaneously for 5 second or longer.

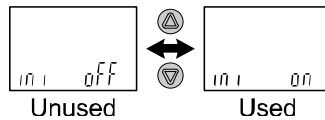

[oFF] (Unused) is selected.
Press the SET button to set.
Return to function selection mode.

All settings are returned to the default values. Return to function selection mode.

[F99] Reset to default settings completed.

Other Settings

○ Snap shot function

The current flow/temperature value can be stored to the switch output ON/OFF set point.

When the items of sub screen (left side) below are selected in 3 step setting mode, simple setting mode or function selection mode ([F 1] Setting of OUT1, [F 2] Setting of OUT2), by pressing the UP and DOWN buttons simultaneously for 1 second or longer, the value of the sub screen (right side) shows [- - -], and then values corresponding to the current flow/temperature are automatically displayed.

Output mode	Configurable items	Sub screen (left side)	Snap shot function
Hysteresis mode	Set value	$P_{-1} (n_{-1}), P_{-2} (n_{-2}),$ $\pm P_{-1} (t_{n_{-1}}), \pm P_{-2} (t_{n_{-2}})$	○
	Hysteresis	$H_{-1}, H_{-2}, \pm H_{-1}, \pm H_{-2}$	○
Window comparator mode	Set value	$P_{1L} (n_{1L}), P_{1H} (n_{1H})$ $\pm P_{1L} (t_{n_{1L}}), \pm P_{1H} (t_{n_{1H}})$ $P_{2L} (n_{2L}), P_{2H} (n_{2H})$ $\pm P_{2L} (t_{n_{2L}}), \pm P_{2H} (t_{n_{2H}})$	○
	Hysteresis	$H_{1L}, H_{1H}, \pm H_{1L}, \pm H_{1H}$ $H_{2L}, H_{2H}, \pm H_{2L}, \pm H_{2H}$	×

• Set value

The value is set to the same value as the display value (current flow/temperature value).

(There is a range which cannot be set to the current flow/temperature value depending on the hysteresis. In that case, the value is set to the closest value.)

• Hysteresis

The hysteresis is calculated from the equation below and set.

Normal output: (set value) - (current flow/temperature value)

Reverse output: (current flow/temperature value) - (set value)

If the calculation result becomes 0 or less, [Err] is displayed on the sub screen (right side) and the set value is not changed.

Afterwards, it is possible to adjust the value by pressing the UP or DOWN button.

○ Peak/bottom value indication

The maximum (minimum) flow/temperature when the power is supplied is detected and updated.

In peak/bottom indication mode, the current pressure is displayed.

Press the UP or DOWN button in measurement mode to switch the sub screen (left side) to the display shown below.

Peak/bottom values are displayed on the sub screen (right side) at the same time as the current flow/temperature value on the main screen.

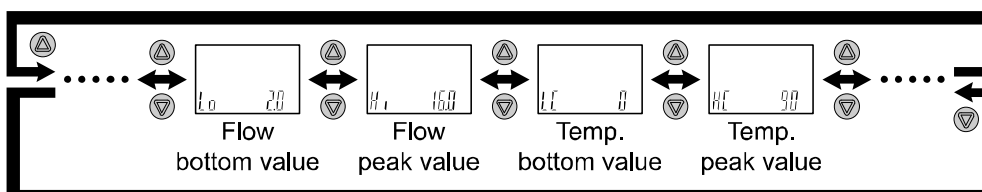

Peak/bottom values are maintained even if the power supply is cut.

When the SET and DOWN buttons are pressed for 1 second or longer simultaneously while the peak/bottom values are displayed, the sub screen (right side) displays [- - -] and the maximum (minimum) flow/temperature value are cleared.

○Key-lock function

The key-lock function is used to prevent errors occurring due to unintentional changes of the set values. If the SET button is pressed while the keys are locked, [LoC] is displayed on the sub screen (left side) for approximately 1 second.

(Each setting and peak/bottom values are displayed with UP and DOWN buttons.)

<Operation - Without security code input ->

- (1) Press the SET button for 5 seconds or longer in measurement mode. When [oPE] is displayed on the main screen, release the button.

The current setting [LoC] or [UnLoC] will be displayed on the sub screen.

(To release key-lock repeat the above operation.)

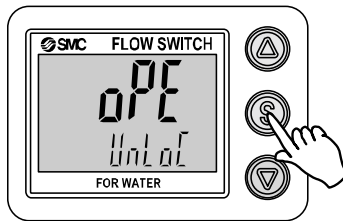

- (2) Select the key-locking/un-locking with UP or DOWN button, and press the SET button to set.

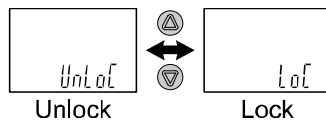

<Operation – With security code input ->

•Locking

- (1) Press the SET button for 5 seconds or longer in measurement mode. When [oPE] is displayed on the main screen, release the button.

The current setting [LoC] or [UnLoC] will be displayed on the sub screen.

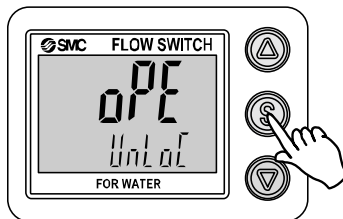

- (2) Select the key [LoC] with UP or DOWN button, and press the SET button to set.

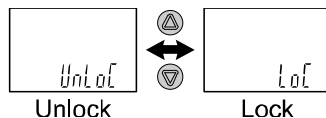

•Unlocking

- (1) Press the SET button for 5 seconds or longer in measurement mode. When [oPE] is displayed on the main screen, release the button.
The current setting [LoC] or [UnLoC] will be displayed on the sub screen.

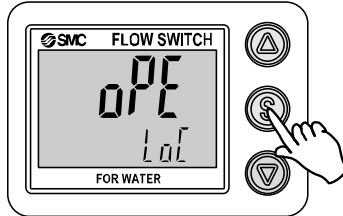

- (2) Select the un-locking [UnLoC] with UP or DOWN button. Setting is recognized by pressing the SET button, then security code is required.

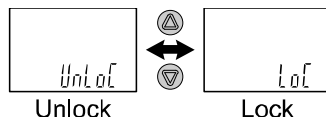

- (3) For instructions on how to enter the security code, refer to "How to input and change the security code" on page 68.

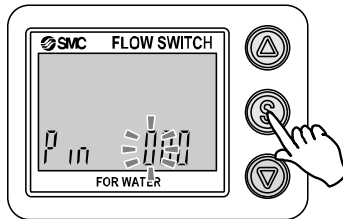

- (4) If inputted security code is correct, the indication of the main screen changes to [UnLoC], and pressing the one of UP, SET or DOWN button releases key-lock and the measurement mode returns.
If the security code entered is incorrect, [FAL] will be displayed, and the security code must be entered again. If the wrong security code is entered 3 times, [LoC] is displayed and the device returns to measurement mode.

● **How to input and change the security code**

The left most digit starts flashing.
Press the UP or DOWN button to select a value.
Press the SET button to make the next digit to the right flash.
(If the SET button is pressed at the last digit, the first digit will start flashing.)

After the setting is complete, Press and hold the SET button for 1 second or longer.
(If an operation is not performed for 30 seconds during input or change of the security code, it will return to measurement mode.)

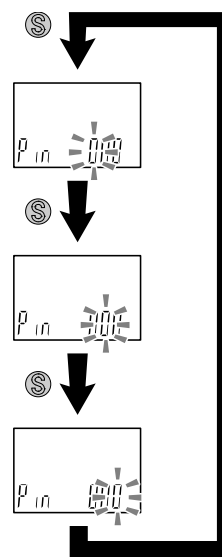

Maintenance

How to reset the product after a power cut or when the power has been unexpectedly removed

The settings of the product are retained from before the power cut or de-energizing.

The output condition also recovers to that before the power cut or de-energizing, but may change depending on the operating environment.

Therefore, check the safety of the whole system before operating the product.

IO-Link Specifications

■ Outline of IO-Link functions

○ Communication function

This product can check the flow/temperature measurement value, diagnostic information and switch output status using cyclic data communication via the IO-Link system.

○ Product status monitoring function

This function monitors the product status via the IO-Link.

- Several errors (e.g. internal hardware errors) can be monitored.
- Several warnings (e.g. temperature sensor error, flow measurement error) can be detected.

○ Data storage function

The Data storage function stores the IO-Link device parameter settings to the IO-Link master.

With the IO-Link data storage function, the IO-Link device can be replaced easily without re-setting the equipment construction or setting parameters

When the device parameter is set and downloaded to the device using the IO-Link setting tool, the parameter will be uploaded to the data storage in the master by the system command after download (backup instruction by the communication command).

When the device is replaced with the same type of IO-Link device due to failure, the parameter settings stored in the master are downloaded automatically, device can be operated with the parameter settings of the previous device.

Device parameter setting is applicable to 3 types of back-up levels of the master setting ("Inactive", "back-up/Restore", "Restore").

"Back-up" implies the activation of upload and "restore" implies download.

■ Communication specifications

IO-Link type	Device
IO-Link version	V1.1
Communication speed	COM2 (38.4 kbps)
Min. cycle time	3.5 ms
Process data length	Input Data: 6 byte, Output Data: 0 byte
On request data communication	Available
Data storage function	Available
Event function	Available

■ Process data

Process data is the data which is exchanged periodically between the master and device.

This product process data consists of switch output status, error diagnostics, flow measurement value and temperature measurement value.

(Refer to the table below.)

Bit offset	Item	Notes
0	OUT1 output	0: OFF 1: ON
1	OUT2 output	0: OFF 1: ON
8	Diagnosis (flow)	0: OFF 1: ON HHH, Set with the index 0x03EB.
9	Diagnosis (temperature)	0: OFF 1: ON tHHH/tLLL, Set with the index 0x03EB.
15	Diagnosis (error)	0: OFF 1: ON Err, Set with the index 0x03EB.
16 to 31	Temperature measurement value	With sign: 16 bit
32 to 47	Flow measurement value	With sign: 16 bit

Bit offset	47	46	45	44	43	43	41	40	39	38	37	36	35	34	33	32
Item	Flow measurement value (PD)															

Bit offset	31	30	29	28	27	26	25	24	23	22	21	20	19	18	17	16
Item	Temperature measurement value (PD)															
	*: The area is not used when the product without temperature sensor is selected.															

Bit offset	15	14	13	12	11	10	9	8	7	6	5	4	3	2	1	0
Item	Erroe	Reservation					Temp.	Flow	Reservation					OUT2	OUT1	
	Diagnosis						Diagnosis							Switch output		

- The process data of this product is Big-Endian type.

When the transmission method of the upper communication is Little-Endian, the byte order will be changed.

Refer to the table below for the Endian type of the major upper communication.

Endian type	Upper communication protocol
Big-Endian type	Such as PROFIBUS and PROFINET
Little-Endian type	Such as EtherNET/IP, EtherCAT and CC-Link IE Field.

○Unit specification and flow/temperature measurement value (PD)

Series	Unit	Flow range	Flow value		PD value					
			Rated flow range		Display/settable range		Rated flow range		Display/settable range	
			Min.	Max.	Min.	Max.	A	to B	C	to D
PF3W7	L/min	4 L	0.50	to 4.00	0.35	to 5.50	125	to 1000	0	to 1375
		16 L	2.0	to 16.0	1.7	to 22.0	125	to 1000	0	to 1375
		40 L	5.0	to 40.0	3.5	to 55.0	125	to 1000	0	to 1375
		100 L	10	to 100	7	to 140	100	to 1000	0	to 1400
	G/min	4 L	0.13	to 1.06	0.09	to 1.54	125	to 1000	0	to 1372
		16 L	0.53	to 4.23	0.45	to 5.81	125	to 1000	0	to 1374
		40 L	1.33	to 1060	0.92	to 14.50	125	to 1000	0	to 1372
		100 L	2.6	to 26.4	1.9	to 37.0	100	to 1000	0	to 1400

Series	Unit	Flow range	Temperature value		PD value					
			Rated temperature range		Display/settable range		Rated temperature range		Display/settable range	
			Min.	Max.	Min.	Max.	a	to b	c	to d
PF3W7	°C	Common	0	to 100	-10	to 110	0	to 1000	-100	to 1100

*: The flow ranges and relationship between the fluid and PD are shown in the figures below.

●Relationship between flow rate and PD

Flow measurement value (PD)

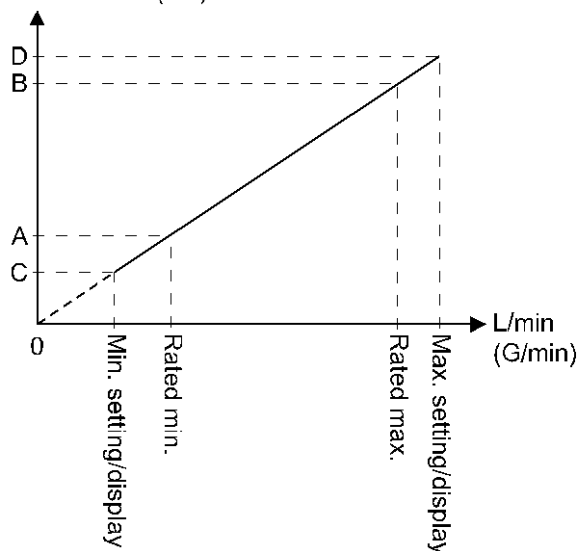

●Relationship between temperature and PD

Temp. measurement value (PD)

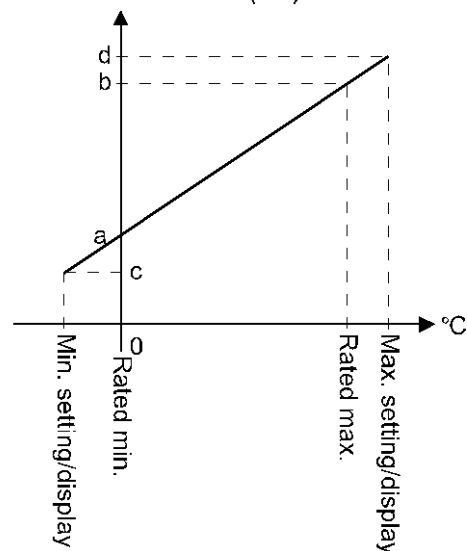

○ Conversion formula of the process data and flow/temperature measurement value

(1) Conversion formula from the process data to the flow/temperature measurement value:

$$Pr = a \times (PD) + b$$

(2) Conversion formula from the flow/temperature gauge measurement value to the process data:

$$(PD) = (Pr - b) / a$$

Pr: Flow/temperature measurement value and pressure set value

PD: Flow/temperature measurement value (process data)

a: Inclination

b: Intercept

[Inclination and intercept to the unit specification]

Series	Unit	Flow range	Inclination a	Intercept b
PF3W7	L/min	4 L	0.004	0
		16 L	0.016	0
		40 L	0.04	0
		100 L	0.1	0
	G/min	4 L	0.001057	0
		16 L	0.004227	0
		40 L	0.01057	0
		100 L	0.02642	0

Series	Unit	Flow range	Inclination a	Intercept b
PF3W7	°C	Common	0.1	0

[Calculation example]

- (1) Conversion from the process data to the flow measurement value
(For PF3W7 series, unit L/min, flow range 16 L and PD = 750)**

$$\begin{aligned}Pr &= a \times (PD) + b \\ &= 0.016 \times 750 + 0 \\ &= 12.0 \text{ [L/min]}\end{aligned}$$

- (2) Conversion from the flow measurement value to the process data
(For PF3W7 series, unit L/min, flow range 16 L and Pr = 0.8 [L/min])**

$$\begin{aligned}(PD) &= (Pr - b) / a \\ &= [0.8 - 0] / 0.016 \\ &= 50\end{aligned}$$

- (1) Conversion from the process data to the temperature measurement value
(For PF3W7 series, unit °C, common flow range and PD = 50)**

$$\begin{aligned}Pr &= a \times (PD) + b \\ &= 0.1 \times 50 + 0 \\ &= 5 \text{ [°C]}\end{aligned}$$

- (2) Conversion from the temperature measurement value to the process data
(For PF3W7 series, unit °C, common flow range and Pr = 45 [°C])**

$$\begin{aligned}PD &= (Pr - b) / a \\ &= [45 - 0] / 0.1 \\ &= 450\end{aligned}$$

■IO-Link parameter setting

○IODD file

IODD (I/O Device Description) is a definition file which provides all properties and parameters required for establishing functions and communication of the device.

IODD includes the main IODD file and a set of image files such as vendor logo, device picture and device icon.

The IODD file is shown below.

Product No.	IODD file *
PF3W7*-*-L* (T)	SMC-PF3W7*-*-L* (T)- * * *-yyymmdd-IODD1.1

: "" indicates the product No., and the product No. applicable to each IODD file input.

*: "yyymmdd" indicates the file preparation date. yyyy is the year, mm is the month and dd is the date.

The IODD file can be downloaded from the SMC Web site (<https://www.smcworld.com>).

○Service data

The tables below indicates the parameters which can be read or written by simple access parameter (direct parameters page) and ISDU parameters which are applicable to various parameters and commands.

●Direct parameters page 1

DPP1 address	Access	Parameter name	Initial value (dec)	Content
0x07	R	Vendor ID	0x0083 (131)	"SMC Corporation"
0x08				
0x09	R	Device ID	0X0160 (352)	PF3W704*-*-L**-*
0x0A			0X0161 (353)	PF3W720*-*-L**-*
			0X0162 (354)	PF3W740*-*-L**-*
			0X0163 (355)	PF3W711*-*-L**-*
			0X0164 (356)	PF3W721*-*-L**-*
			0X0165 (357)	PF3W704*-*-L*T**
0x0B			0X0166 (358)	PF3W720*-*-L*T**
	0X0167 (359)	PF3W740*-*-L*T**		
		0X0168 (360)	PF3W711*-*-L*T**	
		0X0169 (361)	PF3W721*-*-L*T**	

●ISDU parameters

Index (dec)	Sub index	Access *1	Parameters	Initial value	Remarks
0x0002 (2)	0	W	System command	-	Refer to "System command" on page 75.
0x000C (12)	0	R/W	Device access lock	0x0000	Refer to "Device access lock parameter" on page 76.
0x0010 (16)	0	R	Vendor name	SMC Corporation	
0x0011 (17)	0	R	Vendor text	www.smcworld.com	
0x0012 (18)	0	R	Product name	Example: PF3W720-04-LTQ-M-X445	
0x0013 (19)	0	R	Product ID	Example: PF3W720-04-LTQ-M-X445	
0x0014 (20)	0	R	Product text	Flow sensor	
0x0015 (21)	0	R	Serial number	Example: "xxxxxxxx"	•Initial value is indicated as 8-digit. •16 octets fixed character string
0x0016 (22)	0	R	Hardware version	HW-Vx.y	x: Large revision number y: Small revision number
0x0017 (23)	0	R	Software version	FW-Vx.y	x: Large revision number y: Small revision number
0x0024 (36)	0	R	Device status parameter	-	Refer to "Device state parameters" on page 76.
0x0025 (37)	0	R	Device detailed state parameter	-	Refer to "Device detailed state parameter" on page 77.
0x0028 (40)	0	R	Process data input	-	The latest value of process data can be read.

*1: R: Read, W: Write

●System command (index 2)

In the ISDU index 0x002 SystemCommand (system command), the command shown in the table below will be issued.

The button of each system command is displayed on the IO-Link setting tool (excluding "ParamDownloadStore").

Click the button to send the system command to the product.

Writable commands are shown below.

Data type: 8 bit UInteger

Value	Function definition	Description
128	Device Reset	Restarts the device
129	Application Reset	Reset of the peak/bottom value (flow/temperature) Reset of the accumulated flow value
130	Restore Factory Reset	Initialize the set value to the default value.
170	Flow peak bottom Reset	Reset of peak / bottom value (flow rate)
180	Temperature peak bottom Reset	Reset of peak / bottom value (temperature)
190	Integrated flow Reset	Reset of the accumulated flow value

- Device access lock parameter (index 12)

The contents are as follows.

Data type: 16 bit Record

Value	Contents
0	Key lock release, DS unlock (Initial value)
2	Key lock release, DS lock
8	Key lock, DS unlock
10	Key lock, DS lock

[Key lock]

This function prevents the user from physically changing the setting of the flow switch (button operation is not accepted).

Even when key lock function is activated, settings can be changed by IO-Link communication.

Restoration by data storage (overwriting parameter data) can be performed.

[Lock data storage (DS lock)]

Locking "Data storage" will invalidate the data storage function of the flow switch.

In this case, access will be denied for backup and restoration of data storage.

- Device state parameters (index 36)

Readable device states are as follows.

Data type: 8 bit UInteger

Value	State definition	Description
0	Normal operation	-
1	Maintenance inspection required	Not available
2	Outside specification range	Outside the flow measurement range Outside the temperature measurement range Below the temperature measurement range
3	Function check	Not available
4	Failure	Internal failure of digital flow switch

- Device detail status parameters (index 37)

Detailed event contents of readable device status are as follows.

Array	Event content	Event classification		Event code
		Definition	Value	
1	Internal failure of digital flow switch	Error	0xF4	0x8D01
2	Internal failure of digital flow switch	Error	0xF4	0x8D07
3	Internal failure of digital flow switch	Error	0xF4	0x8D02
4	Internal failure of digital flow switch	Error	0xF4	0x8D03
5	Internal failure of digital flow switch	Error	0xF4	0x8D04
6	Internal failure of digital flow switch	Error	0xF4	0x8D05
7	Internal failure of digital flow switch	Error	0xF4	0x8D06
8	Reserved			
9	Temperature sensor error	Error	0xF4	0x8CC0
10	Outside the fluid temperature range	warning	0xE4	0x8CC1
11	Below the fluid temperature range	warning	0xE4	0x8CC2
12	Outside the accumulated flow measurement	warning	0xE4	0x8CC3
13	Outside the instantaneous flow measurement	warning	0xE4	0x8C10
14	-	-	0x00	0x0000
15	-	-	0x00	0x0000
16	Data storage upload request	notification	0x54	0xFF91

●Product individual parameters

Index		Sub index	Access *1	Parameter	Data type *2	Initial value	Data storage *3	Set value	Remarks
dec	hex								
1000	0x03E8	0	R/W	Unit (Selection of display unit)	U8	0	Y	0: L 1: G	When the unit selection function is not included, a read/write to an un-selectable item is rejected.
1001	0x03E9	0	R/W	NorP (Selection of switch output PNP/NPN)	U8	1	Y	0: NPN 1: PNP	Setting of switch output specification
1002	0x03EA	0	R/W	CoL (Selection of display colour)	U8	2	Y	0: rEd (Constantly red) 1: Grn (Constantly green) 2: 1SoG (OUT1 turns green at ON) 3: 1Sor (OUT1 turns red at ON) 4: 2SoG (OUT2 turns green at ON) 5: 2Sor (OUT2 turns green at ON)	Setting of display colour
1003	0x03EB	0	R/W	diAG (Selection of diagnostic information)	U8	1	Y	1: oFF 2: on	Sets the diagnostic information bit of the input process data. OFF: Not used ON: Turns on in case of the following: Product internal failure OUT2 over current error Temp. sensor error Outside of temp. range Below the temp. range Outside of instantaneous flow range
1010	0x03F2	0	R/W	oUt1 (Selection output mode)	U8	0	Y	0: HYS (Hysteresis) 1: Wind (window comparator) 2: AC (Accumulated output) 3: PLS (Accumulated pulse) 4: tHYS (Temp. hysteresis) 5: tWIN (Temp. window) 6: Err (Error output) 7: oFF (Output OFF)	Setting of OUT1 output mode With no temp. sensor connected, the following items cannot be selected: 4: tHYS 5: tWIN
1011	0x03F3	0	R/W	1ot (Selection of output type)	U8	0	Y	0: 1_P (Normal output) 1: 1_n (Reverse output)	Setting of OUT1 output normal and reserved output.
1012	0x03F4	0	R/W	P_1(n_1) (Selection of output set value)	S16	500	Y	Setting range Refer to "Settable range list". (Page 82)	Setting of OUT1 output set value (Hysteresis)
1013	0x03F5	0	R/W	H_1 (Setting of OUT1 hysteresis)	U16	50	Y	Setting range Refer to "Settable range list". (Page 82)	Setting of OUT1 hysteresis (Hysteresis)
1014	0x03F6	0	R/W	P1L(n1L) (Lower limit of window comparator)	S16	300	Y	Setting range Refer to "Settable range list". (Page 82)	Setting of OUT1 output set value (Lower limit of window comparator)
1015	0x03F7	0	R/W	P1H(n1H) (Upper limit of window comparator)	S16	600	Y	Setting range Refer to "Settable range list". (Page 82)	Setting of OUT1 output set value (Upper limit of window comparator)
1016	0x03F8	0	R/W	WH1 (Window comparator hysteresis)	U16	100	Y	Setting range Refer to "Settable range list". (Page 82)	Setting of OUT1 hysteresis (Window comparator)
1017	0x03F9	0	R/W	dtH1 (Delay time at ON)	U16	0	Y	Settable values 0x0000 to 0x1770	Setting of OUT1 delay time at ON 10 ms increment
1018	0x03FA	0	R/W	dtL1 (Delay time at OFF)	U16	0	Y	(0 to 6000)	Setting of OUT1 delay time at OFF 10 ms increment

●Product individual parameters (continued)

Index		Sub index	Access *1	Parameter	Data type *2	Initial value	Data storage *3	Set value	Remarks
dec	hex								
1020	0x03FC	0	R/W	oUt2 (Selectino output mode)	U8	Without temp. sensor: 0 With temp. sensor: 4	Y	0: HYS (Hysteresis) 1: Wind (Window comparator) 2: AC (Accumulated output) 3: PLS (Accumulated pulse) 4: tHYS (Temp. hysteresis) 5: tWIn (Temp. window) 6: Err (Error output) 7: oFF (Output OFF)	Setting of OUT2 output mode With no temp. sensor connected, the following items cannot be selected: 4: tHYS 5: tWIn
1021	0x03FD	0	R/W	2ot (Selection of output type)	U8	Without temp. sensor: 0 With temp. sensor: 1	Y	0: 2_P (Normal output) 1: 2_n (Reverse output)	Setting of OUT2 normal and reversed output
1022	0x03FE	0	R/W	P_2(n_2) (Selection of output set value)	S16	500	Y	Setting range Refer to "Settable range list". (Page 82)	Setting of OUT2 output set value (Hysteresis)
1023	0x03FF	0	R/W	H_2 (Setting of OUT2 hysteresis)	U16	50	Y	Setting range Refer to "Settable range list". (Page 82)	Setting of OUT2 hysteresis (Hysteresis)
1024	0x0400	0	R/W	P2L(n2L) (Lower limit of window comparator)	S16	300	Y	Setting range Refer to "Settable range list". (Page 82)	Setting of OUT2 output set value (Lower limit of window comparator)
1025	0x0401	0	R/W	P2H(n2H) (Upper limit of window comparator)	S16	600	Y	Setting range Refer to "Settable range list". (Page 82)	Setting of OUT2 output set value (Upper limit of window comparator)
1026	0x0402	0	R/W	WH2 (Window comparator hysteresis)	U16	100	Y	Setting range Refer to "Settable range list". (Page 82)	Setting of OUT2 hysteresis (Window comparator)
1027	0x0403	0	R/W	dtH2 (Delay time at ON)	U16	0	Y	Settable values 0x0000 to 0x1770 (0 to 6000)	Setting of OUT2 delay time at ON 10 ms increment
1028	0x0404	0	R/W	dtL2 (Delay time at OFF)	U16	0	Y		Setting of OUT2 delay time at OFF 10 ms increment
1030	0x0406	0	R/W	FiL (Digital filter)	U8	0	Y	0: 0.5 sec 1: 1.0 sec 2: 2.0 sec 3: 5.0 sec 4: 10.0 sec 5: 15.0 sec 6: 20.0 sec 7: 30.0 sec	Setting of digital filter
1040	0x0410	0	R/W	tP_1(tn_1) (Selection of temp. output set value)	S16	500	Y	Setting range 0xFF9C to 0x044C (-100 to 1100)	Setting of OUT1 output set value (Temp. hysteresis)
1041	0x0411	0	R/W	tH_1 (Temp. hysteresis)	U16	50	Y	Setting range 0x0000 to 0x04B0 (0 to 1200)	Setting of OUT1 hysteresis (Temp. hysteresis)
1042	0x0412	0	R/W	tP1L(tn1L) (Lower limit of temp. window comparator)	S16	300	Y	Setting range 0xFF9C to 0x044C (-100 to 1100)	Setting of OUT1 output set value (Lower limit of temp. window comparator)
1043	0x0413	0	R/W	tP1H(tn1H) (Upper limit of temp. window comparator)	S16	600	Y	Setting range 0xFF9C to 0x044C (-100 to 1100)	Setting of OUT1 output set value (Upper limit of temp. window comparator)
1044	0x0414	0	R/W	tWH1 (Temp. window comparator hysteresis)	U16	100	Y	Setting range 0x0000 to 0x0258 (0 to 600)	Setting of OUT1 hysteresis (Temp. window comparator)

●Product individual parameters (continued)

Index		Sub index	Access *1	Parameter	Data type *2	Initial value	Data storage *3	Set value	Remarks	
dec	hex									
1045	0x0415	0	R/W	OUT1 setting (temperature)	tP_2(tn_2) (Selection of temp. output set value)	S16	500	Y	Setting range 0xFF9C to 0x044C (-100 to 1100)	Setting of OUT2 output set value (Temp. hysteresis)
1046	0x0416	0	R/W		tH_2 (Temp. hysteresis)	U16	50	Y	Setting range 0x0000 to 0x04B0 (0 to 1200)	Setting of OUT2 hysteresis (Temp. hysteresis)
1047	0x0417	0	R/W		tP2L(tn2L) (Lower limit of temp. window comparator)	S16	300	Y	Setting range 0xFF9C to 0x044C (-100 to 1100)	Setting of OUT2 output set value (Lower limit of temp. window comparator)
1048	0x0418	0	R/W		tP2H(tn2H) (Upper limit of temp. window comparator)	S16	600	Y	Setting range 0xFF9C to 0x044C (-100 to 1100)	Setting of OUT2 output set value (Upper limit of temp. window comparator)
1049	0x0419	0	R/W		tWH2 (Temp. window comparator hysteresis)	U16	100	Y	Setting range 0x0000 to 0x0258 (0 to 600)	Setting of OUT2 hysteresis (Temp. window comparator)
1070	0x042E	0	R/W	Accumulated value setting	AC (Setting of the accumulated flow output direction)	U8	0	Y	0: Add (Addition) 1: dEC1 (Subtraction OUT1) 2: dEC2 (Subtraction OUT2)	Setting of the accumulated flow output direction
1073	0x0431	1	R/W		AC1_L (OUT1 set value (L))	U16	0	Y	Setting range 0x0000 to 0x270F (0 to 9999)	Setting of the OUT1 set value Unit specification (Unit): When "L" is selected.
		2	R/W		AC1_L (OUT1 index (G))	S16	0		Setting range 0xFFFE to 0x0006 (-2 to 6)	Setting of OUT1 index Unit specification (Unit): When "L" is selected.
1074	0x0432	1	R/W		AC1_G (OUT1 set value (G))	U16	0	Y	Setting range 0x0000 to 0x270F (0 to 9999)	Setting of the OUT1 set value Unit specification (Unit): When "G" is selected.
		2	R/W		AC1_G (OUT1 index (G))	S16	0		Setting range 0xFFFE to 0x0006 (-2 to 6)	Setting of OUT1 index Unit specification (Unit): When "G" is selected.
1075	0x0433	1	R/W		AC2_L (OUT2 set value (L))	U16	0	Y	Setting range 0x0000 to 0x270F (0 to 9999)	Setting of the OUT2 set value Unit specification (Unit): When "L" is selected.
		2	R/W		AC2_L (OUT2 index (G))	S16	0		Setting range 0xFFFE to 0x0006 (-2 to 6)	Setting of OUT2 index Unit specification (Unit): When "L" is selected.
1076	0x0434	1	R/W		AC2_G (OUT2 set value (G))	U16	0	Y	Setting range 0x0000 to 0x270F (0 to 9999)	Setting of the OUT2 set value Unit specification (Unit): When "G" is selected.
		2	R/W		AC2_G (OUT2 index (G))	S16	0		Setting range 0xFFFE to 0x0006 (-2 to 6)	Setting of OUT2 index Unit specification (Unit): When "G" is selected.

●Product individual parameters (continued)

Index		Sub index	Access *1	Parameter	Data type *2	Initial value	Data storage *3	Set value	Remarks	
dec	hex									
1100	0x044C	0	R/W	Upper level screen	Sub (Setting of lower level screen)	U8	0	Y	0: dEF (Default) 1: LinE (Line name) 2: oFF (Display OFF)	
1101	0x044D	0	R/W		dEF (During dEF setting Selection of display item)	U8	Without temp. sensor: 0 With temp. sensor: 30	Y	Refer to "Selection of display items" when dEF is set. (Page 83)	
1300	0x0514	0	R/W		SAVE (Accumulated flow value hold setting)	U8	0	Y	0: oFF (Not held) 1: 2.0 min 2: 5.0 min	
1800	0x0708	0	R/W		diSP (Display OFF setting)	U8	0	Y	0: on 1: oFF	
1810	0x0712	0	R/W	Security code	Pin (Security code Used/Not used)	U8	0	Y	0 :unused 1: use	
1811	0x0713	0	R/W		PinCode (Security code setting)	U16	0	Y	Setting range 0x0000 to 0x03E7 (0 to 999)	
1820	0x071C	0	R/W	Lower level screen	Line name 1st letter	U8	0	Y	Refer to "[Line name: communication data". (Page 84)	
1821	0x071D	0	R/W		Line name 2nd letter	U8	0	Y		
1822	0x071E	0	R/W		Line name 3rd letter	U8	0	Y		
1823	0x071F	0	R/W		Line name 4th letter	U8	0	Y		
1824	0x0720	0	R/W		Line name Left side bot	U8	0	Y	0: oFF (dot OFF) 1: on (dot ON)	
1825	0x0721	0	R/W		Line name Centre bot	U8	0	Y		
1826	0x0722	0	R/W		Line name Right side bot	U8	0	Y		
2000	0x07D0	0	R	Measurement related	Inclination of flow rate PD a	F32	-	N	Refer to "Inclination and intercept". (Page 72)	
2001	0x07D1	0	R		Flow rate PD intercept b	F32	-	N	Refer to "Inclination and intercept". (Page 72)	
2002	0x07D2	0	R		Flow peak value	S16	0	N	PF3W704/720/740	
2003	0x07D3	0	R		Flow bottom value	S16	0	N	0x0000 to 0x055F	
2010	0x07DA	0	R		Temp. PD inclination a	F32	-	N	Refer to "Inclination and intercept to the unit specification" (Page 72)	Only when a temp. sensor is connected.
2011	0x07DB	0	R		Temp. PD intercept b	F32	-	N	Refer to "Inclination and intercept". (Page 72)	Only when a temperature sensor is connected.
2012	0x07DC	0	R		Temp. peak value	S16	0	N	0xFF9C to 0x044C (-100 to 1100)	Can be displayed only when a temperature sensor is connected.
2013	0x07DD	0	R		Temp. bottom value	S16	0	N		
2021	0x07E5	0	R		Accumulated PD	U16	0	N	0x0000 to 0x270F (0 to 9999)	Accumulated PD×Accumulated value conversion factor = Current accumulated flow value

*1: "R" means Read and "W" means Write.

*2: Refer to the table below for the symbol.

Symbol	Data type (IO-Link standard)	Data length Bit [byte]	Description
U8	UIntegerT	8[1]	Unsigned integer
U16		16[2]	
S16	IntegerT	16[2]	Signed integer
F32	Float32T	32[4]	Floating point number

*3: "Y" indicates that the parameter setting data is saved to the master, and "N" indicates that the parameter is not saved.

*4: Read/write to un-selectable items will be rejected depending on the product No.

[Set range list]

Item	Setting range (PD)			
	4 L	16 L	40 L	100 L
P_1/P_2 (n_1/n_2)	0x0057 to 0x055F (87 to 1375)	0x006A to 0x055F (106 to 1375)	0x0057 to 0x055F (87 to 1375)	0x0046 to 0x0578 (70 to 1400)
H_1/H_2	0x0000 to 0x0508 (0 to 1288)	0x0000 to 0x04F5 (0 to 1269)	0x0000 to 0x0508 (0 to 1288)	0x0000 to 0x0532 (0 to 1330)
P1L/P2L (n1L/n2L)	0x0057 to 0x055F (87 to 1375)	0x006A to 0x055F (106 to 1375)	0x0057 to 0x055F (87 to 1375)	0x0046 to 0x0578 (70 to 1400)
P1H/P2H (n1H/n2H)	0x0057 to 0x055F (87 to 1375)	0x006A to 0x055F (106 to 1375)	0x0057 to 0x055F (87 to 1375)	0x0046 to 0x0578 (70 to 1400)
H1/WH2	0x0000 to 0x0284 (0 to 644)	0x0000 to 0x027A (0 to 634)	0x0000 to 0x0284 (0 to 644)	0x0000 to 0x0299 (0 to 665)

[dEF Selection of display items during standard setting]

Value	Setting content	Supplemental information
0	HYS mode set value	When the value which does not match the OUT* output mode setting is written, acknowledgment is sent
1	HYS mode hysteresis	
2	Wind mode lower side set value	
3	Wind mode upper side set value	
4	Wind mode hysteresis	
5	Accumulated output mode	
6	Accumulated pluse output mode	
7	tHYS mode set value	
8	tHYS mode hysteresis	
9	tWind mode lower side set value	
10	tWind mode upper side set value	
11	tWind mode hysteresis	
12	Err mode	
13	oFF mode	
14	HYS mode set value	
15	HYS mode hysteresis	
16	Wind mode lower side set value	
17	Wind mode upper side set value	
18	Wind mode hysteresis	
19	Accumulated output mode	
20	Accumulated pluse output mode	
21	tHYS mode set value	
22	tHYS mode hysteresis	
23	tWind mode lower side set value	
24	tWind mode upper side set value	
25	tWind mode hysteresis	
26	Err mode	
27	oFF mode	
28	Flow peak value	
29	Flow bottom value	
30	Fluid temperature display	
31	Flow temp. peak value	
32	Flow temp. bottom value	
33	Accumulated flow value	
34	Switch output mode/communication mode display	

	Default															
16 hex number	00	01	02	03	04	05	06	07	08	09	0A	0B	0C	0D	0E	0F
Display letter	0	1	2	3	4	5	6	7	8	9	A	B	C	D	E	F
16 hex number	10	11	12	13	14	15	16	17	18	19	1A	1B	1C	1D	1E	1F
Display letter	0	1	2	3	4	5	6	7	8	9	A	B	C	D	E	F
16 hex number	20	21	22	23	24	25	26	27	28	29	2A	2B	2C	2D	2E	2F
Display letter	0	1	2	3	4	5	6	7	8	9	A	B	C	D	E	F

Line name: Communication data (11 seg)

Troubleshooting

Troubleshooting

Applicable Flow switch: PF3W7 series

If an operation failure occurs with the product, use the chart below to find out the cause of problem.

If a cause applicable to the failure cannot be identified and normal operation can be recovered by replacement with a new product, this indicates that the product itself was faulty. The damage to the product may have been caused by operating environment (network construction, etc.). Consult with SMC separately to obtain countermeasures.

Cross-reference for troubleshooting

Fault	Detail	Possible cause	Item to check	Recommended action
Incorrect display	No display	Incorrect wiring	Check if the brown wire DC(+) and blue wire DC(-) are connected correctly.	Correct the wiring.
		Loose connector	Check that the connector is connected.	Connect the connector.
	The display is unstable.	Foreign matter has entered or got stuck inside the flow passage of the sensor.	Confirm whether foreign matter may enter.	We recommend a filter with filtration of approx. 40 mesh.
		Piping is connected in the wrong direction.	Confirm whether the mounting direction of the product corresponds to the flow direction.	Make the mounting direction correspond to the flow direction.
		Insufficient water supply	Confirm whether the fluid path is full.	Fill up the fluid path.
		Pulsation in the flow.	Confirm whether the supply pressure fluctuates, or whether pulsation is generated due to the characteristics of the compressor or pump used as the pressure source.	Change to a pump that has less pulsation. Install a tank to reduce the pressure fluctuation. Change the piping to elastic piping such as rubber hose.
	Incorrect display	Foreign matter has entered or got stuck inside the flow passage of the sensor.	(1) Confirm whether foreign matter may enter. (2) Confirm whether any foreign matter has got stuck inside.	We recommend a filter with filtration of approx. 40 mesh. Remove foreign matter.
		Piping is connected in the wrong direction.	Confirm whether the mounting direction of the product corresponds to the flow direction.	Make the mounting direction correspond to the flow direction.
		Insufficient water supply	Confirm whether the fluid path is full.	Fill up the fluid path.
		Liquid leakage	Check for liquid leaks due to insufficient tightening of the screw at the piping and/or improper sealing.	Tighten to the specified torque when piping and/or apply the seal tape once again.
	Flow does not start.	The flow adjustment valve is closed.	Check the condition of the flow adjustment valve.	Open the flow adjustment valve to get appropriate flow.

Fault	Detail	Possible cause	Item to check	Recommended action	
Incorrect display	Even though the flow rate is zero, it is displayed.	Operation of pump while the flow adjustment valve is closed.	Check the condition of the flow adjustment valve and pump.	Open the flow adjustment valve slightly, and let the pulsation (pressure) from the pump escape.	
Incorrect output	No output	Incorrect wiring	Check if the brown wire DC(+), blue wire DC(-), black wire(OUT1) and white wire(OUT2) are connected correctly.	Correct the wiring.	
		Loose connector	Check that the connector is connected.	Connect the connector.	
		The flow adjustment valve is closed.	Check the condition of the flow adjustment valve.	Open the flow adjustment valve to get appropriate flow.	
	Output is unstable.	Foreign matter has entered or got stuck inside the flow passage of the sensor.	(1) Confirm whether foreign matter may enter. (2) Confirm whether any foreign matter has got stuck inside.		We recommend a filter with filtration of approx. 40 mesh. Remove foreign matter.
		Piping is connected in the wrong direction.	Confirm whether the mounting direction of the product corresponds to the flow direction.		Make the mounting direction correspond to the flow direction.
		Insufficient water supply	Confirm whether the fluid path is full.		Fill up the fluid path.
		Pulsation in the flow.	Confirm whether the supply pressure fluctuates, or whether pulsation is generated due to the characteristics of the compressor or pump used as the pressure source.		Change to a pump that has less pulsation. Install a tank to reduce the pressure fluctuation. Change the piping to elastic piping such as rubber hose.
		Liquid leakage	Check for liquid leaks due to insufficient tightening of the screw at the piping and/or improper sealing.		Tighten to the specified torque when piping and/or apply the seal tape once again.
		Noise	Confirm that there is no power line or high voltage line that can be a noise source in the wiring route.		Do not route wires and cables together with power or high voltage cables.
		Hysteresis value too low.	Confirm to what level the hysteresis is set.		Increase the hysteresis set value.
Push buttons not operating.	No reaction when the buttons are pressed.	Key-lock mode is activated.	Check if "LoC" displayed when the button is pressed.	Cancel the key-lock function. (Refer to page 66)	

Fault	Detail	Possible cause	Item to check	Recommended action
Improper operation of the external input.	No reaction to the external Input.	Incorrect wiring	Check if the brown wire DC(+), blue wire DC(-), black wire(OUT1) and white wire(OUT2) are connected correctly.	Correct the wiring.
		The input duration is too short.	Confirm whether the input line is connected to GND for a minimum of 30 msec.	When the external input is applied, the input line must be connected to GND for a minimum of 30 msec.
Incorrect temp. sensor displays.	The temp. is not displayed.	Setting condition of the sub screen	Check the content of the sub screen.	Set the sub screen to the temperature display.
		Connector loose	Check that the connector is connected.	Connect the connector.
	Incorrect display	Insufficient water supply	Confirm whether the fluid path is full.	Fill up the fluid path.
		Foreign matter	Check if foreign matter is stuck to the sensor.	Remove foreign matter.
Incorrect temp. sensor output.	Output is unstable.	Insufficient water supply	Confirm whether the fluid path is full.	Fill up the fluid path.
		Foreign matter	Check if foreign matter is stuck to the sensor.	Remove foreign matter.
Improper operation of the flow adjustment valve.	It is not possible to adjust with flow adjustment valve.	Lock the flow adjustment valve	Check the condition of the flow adjustment valve and its lock ring.	Loose the lock ring and adjust flow rate. (Refer to page 23)
		Insufficient supply pressure	Check flow rate characteristics of the supply pressure and flow rate adjustment valve.	Increase supply pressure.





○ Troubleshooting list (IO-Link communication)

Problem	Description	Problem possible causes	Investigation method	Countermeasures
IO-Link indicator light ☐: OFF	-	incorrect wiring	Check the connection of the connector.	Correct the cable wiring.
		Power supply error from the IO-Link master	Check the power supply voltage from the IO-Link master.	Supply 18 to 30 VDC to the IO-Link master.
IO-Link indicator light ⊖: Flashing	Mode ***	Communication is not established. IO-Link wiring failure	Check the connection and cable condition of the IO-Link cable.	Additionally tighten the IO-Link cable. (Replace the cable if it is broken.)
IO-Link indicator light ⊖: Flashing	Er 15 V1.0	IO-Link master and product version are not matched.	Check the IO-Link version of the master and device.	Align the master IO-Link version to the device. *1
	Mode Start	Communication mode is not transferred to the Operation mode.	Check the setting of the data storage access lock and data storage backup level of the master.	Release the data storage access lock. Or deactivate the setting of the data storage backup level of the master port.
	Mode Lock	Backup and restore required during data storage lock	Check the data storage lock.	Release the data storage lock.
Data is swapped by byte.	-	Program data assignment is incorrect.	Check that the Endian type on the master upper level communication transmission format is Big Endian type or Little Endian type.	Assign the program data based on the Endian type of the transmission format of the master upper level communication. Or set to the master byte swap setting. (Refer to page 70 for the Endian type of the upper level communication)

*1: When the product is connected to the master with version "V1.0", error Er15 is generated.

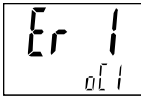
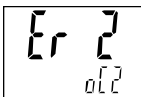
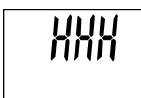
○Error indication function

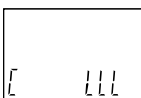
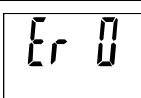
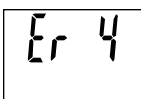
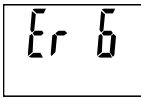
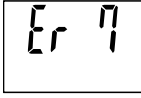
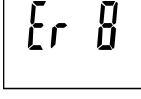
This function is to display error location and content when a problem or error has occurred.

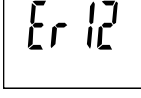
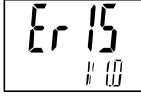
Error	Error displayed	Description	Measures
OUT1 over current error		A load current applied to the switch output has exceeded the max. value (OUT1).	Turn the power off and remove the cause of the over current. Then turn the power on again.
OUT2 over current error		A load current applied to the switch output has exceeded the max. value (OUT2).	
Excessive instantaneous flow		The applied flow rate is above approx. 140% of maximum rated flow.	Reset applied flow to a level within the display range.
Excessive accumulated flow		The accumulated flow range is exceeded. (The decimal point position changes depending on the flow range.)	Reset the accumulated flow once. (Press the SET and DOWN button for 1 second or longer.)
Temperature upper limit exceeded		The fluid temperature is above 110 °C.	Reduce the fluid temperature.
Temperature lower limit under		The fluid temperature is below -10 °C.	Rise the fluid temperature.
System error	     	Displayed if an internal data error has occurred.	Turn the power off and turn it on again. If the failure cannot be solved, contact SMC for repair.
Temperature sensor failure		The temperature sensor is damaged.	
Version does not match		Version of master and IO-Link does not match. Mismatch because master version is 1.0.	Align the master IO-Link version to the device.

If the error cannot be reset after the above measures are taken, or errors other than above are displayed, please contact SMC.

Specifications

Body specification (Flow unit: L)

Model	PF3W704	PF3W720	PF3W740	PF3W711	PF3W721
Applicable fluid	Water and ethylene glycol solution with a viscosity of 3mPa·s (3 cP) or less *1				
Detection method	Karman vortex				
Rated flow range	0.5 to 4 L/min	2 to 16 L/min	5 to 40 L/min	10 to 100 L/min	50 to 250 L/min
Display flow range	0.35 to 5.50 L/min (Flow under 0.35 L/min is displayed as "0.00".)	1.7 to 22.0 L/min (Flow under 1.7 L/min is displayed as "0.0".)	3.5 to 55.0 L/min (Flow under 3.5 L/min is displayed as "0.0".)	7 to 140 L/min (Flow under 7 L/min is displayed as "0".)	20 to 350 L/min (Flow under 20 L/min is displayed as "0".)
Switch point range	0.35 to 5.50 L/min	1.7 to 22.0 L/min	3.5 to 55.0 L/min	7 to 140 L/min	20 to 350 L/min
Min. setting unit	0.01 L/min	0.1 L/min		1 L/min	
Conversion of accumulated pulse (Pulse width = 50 ms)	0.05 L/pulse	0.1 L/pulse	0.5 L/pulse	1 L/pulse	
Fluid temperature	0 to 90 °C (No freezing and condensation)				0 to 70 °C (No freezing and condensation)
Display unit	L/min for real-time flow and L for accumulated flow				
Accuracy	±3%F.S.				
Repeatability	±2%F.S. *2				
Temperature characteristics	±5%F.S. max. (25 °C reference)				
Operating pressure range *3	Refer to graph of operating pressure and proof pressure				
Proof pressure *3	Refer to graph of operating pressure and proof pressure				
Pressure loss	Refer to graph of pressure loss				
Accumulated flow range *4	999,999,999.9 L		9,999,999,999 L		
	By 0.1 L		By 1 L		
Switch output	Select from NPN or PNP open collector output				
Max. load current	80 mA				
Max. applied voltage	30 V (during NPN output)				
Internal voltage drop	1.5 V or less (Load current 80 mA)				
Delay time *5	3.5 ms or less Variable at 0 to 60 s/0.01 step				
Hysteresis	Hysteresis mode	Variable from 0			
	Window comparator mode				
Output protection	Short circuit protection				
Output mode	Flow	Selects one of the output (hysteresis or window comparator mode), the output for the accumulated flow, the accumulated pulse output, error output and switch OFF.			
	Temp.	Selects the output for fluid temperature (hysteresis mode or window comparator mode).			

Model	PF3W704	PF3W720	PF3W740	PF3W711	PF3W721	
Display method	2-screen display (main screen, sub screen) Main screen: 4-digit, 7-segment, 2-colour; red/green Sub screen: 9-digit, 11-segment (5 th digit is 7-segment only), White Display updating frequency 5 times/sec.					
Indicator light	Output 1 and 2: Orange					
Power supply voltage	Used as switch output device	12 to 24 VDC, including ripple (p-p) 10%				
	Used as IO-Link device	18 to 30 VDC, including ripple (p-p) 10%				
Current consumption	50 mA max.					
Digital filter *6	Select from 0.5 s/1.0 s/2.0 s/5.0 s/10.0 s/15.0 s/20.0 s/30.0 s					
Environment	Enclosure	IP65				
	Operating temperature range	0 to 50 °C (No freezing and condensation)				
	Operating humidity range	Operation, Storage: 35 to 85%R.H. (No condensation)				
	Withstand voltage *7	1000 VAC, for 1 minute between the terminals and housing				
	Insulation resistance	50 MΩ min. (with 500 VDC) between the terminals and housing				
Standards and regulations	CE marked (EMC directive, RoHS directive)					
Material of fluid contact parts	PPS, SUS304, FKM, SCS13				PPS, SUS304, FKM	
	Grease free					
Piping port size *8	3/8	3/8、1/2	1/2、3/4	3/4、1	1 1/4、1 1/2	
Weight	Flow switch only	153 g	171 g	228 g	720 g	890 g
	With temperature sensor	166 g	184 g	248 g	748 g	1075 g
	With flow adjustment valve	241 g	259 g	429 g	—	—
	With temperature sensor and flow adjustment valve	254 g	272 g	449 g	—	—
	With lead wire	+85 g				
	With conversion cable for M12-M8	+19 g				
Communication spec. (During IO-Link mode)	IO-Link type	Device				
	IO-Link version	V1.1				
	Communication speed	COM2 (38.4 kbps)				
	Min. cycle time	3.5 ms				
	Process data length	Input Data: 6 byte, Output Data: 0 byte				
	On request data communication	Available				
	Data storage function	Available				
	Event function	Available				
	Vendor ID	131 (0x0083)				
Device ID *9	Refer to direct parameters page 1 (page 74)					

- *1: Please refer to the chart of measurement range of ethylene glycol aqueous solution on page 94. Measurement is possible as long as the fluid does not corrode the wetted parts, and viscosity is 3mPa•s (3 cP) or less. Be aware that water leakage may happen due to internal seal shrinkage or swelling depending on kinds of fluid.
- *2: When 0.5 s is selected in the digital filter setting, the repeatability will be $\pm 3\%$ F.S.
- *3: The operating pressure range and proof pressure vary depending on the fluid temperature. Refer to the chart on page 96.
- *4: The accumulated value will be cleared by turning off the power supply. It is possible to select the function to memorize it. (Every 2 or 5 minutes.)
When 5 minutes interval is selected, take into consideration the maximum number of times it is possible to write to the memory device (electronic part), which is 3.7 million times (In case of 24-hour communication, 5 minutes \times access cycle (3.7 million cycles) = 18.50 million = approx. 35 years). Calculate the life in your operating conditions before using the memorizing function and use within this range.
- *5: Digital filter value is not included.
- *6: The response time is when the set value is 90% in relation to the step input. (The value will be 7 s for the temperature sensor output.)
- *7: When the temperature sensor is used, it will be 250 VAC.
- *8: If a reduced piping diameter or the piping layout cause a restriction, it may not satisfy the specifications.
- *9: •The form of the G thread (including the major and minor diameter and pitch of the internal thread) is based on JIS B0202 (ISO228-1).
•Products indicated as ISO1179-1 (G thread for hydraulics) or ISO16030 (G thread for pneumatics) are based on JIS B0202 (ISO228-1) for effective depth of thread, seat surface area, surface roughness and squareness.
•For ISO1179-1 (G thread for hydraulics), the withstand pressure is specified for each product. SMC do not guarantee the withstand pressure specified in ISO1179-1, ISO1179-2, ISO1179-3, or ISO1179-4.
•For ISO16030 (G thread for pneumatics), the withstand pressure is specified for each product. SMC do not guarantee the withstand pressure specified in ISO16030.
- *9: The Device ID varies depending on the product No.

Specifications of temperature sensor

Items	Specifications
Rated temperature range	0 to 100 °C *1
Setting/display temperature range	-10 to 110 °C
Min. setting/display unit	1 °C
Display unit	°C
Display accuracy	± 2 °C
Response	7 s *2
Ambient temperature characteristics	$\pm 5\%$ F.S.

- *1: The rated temperature range is only for the temperature sensor. As a whole product, the fluid temperature range is specified as 0 to 90 °C.
- *2: The response time is only for the temperature sensor.

Body specification (Flow unit: G)

Model	PF3W704	PF3W720	PF3W740	PF3W711	PF3W721
Rated flow range	0.13 to 1.06 gal/min	0.53 to 4.23 gal/min	1.3 to 10.6 gal/min	2.6 to 26.4 gal/min	13 to 66 gal/min
Display flow range	0.09 to 1.45 gal/min (Flow under 0.09 L/min is displayed as "0.00".)	0.45 to 5.81 gal/min (Flow under 0.45 L/min is displayed as "0.00".)	0.9 to 14.5 gal/min (Flow under 0.9 L/min is displayed as "0.0".)	1.8 to 37.0 gal/min (Flow under 1.8 L/min is displayed as "0.0".)	5 to 92 gal/min (Flow under 5 L/min is displayed as "0".)
Setting flow range	0.09 to 1.06 gal/min	0.45 to 5.81 gal/min	0.9 to 14.5 gal/min	1.8 to 37.0 gal/min	5 to 92 gal/min
Min. setting unit	0.01 L/min		0.1 L/min		1 L/min
Accumulated flow range	99,999,999.99 gal	999,999,999.9 gal		9,999,999,999 gal	
	By 0.01 gal	By 0.1 gal		By 1 gal	
Conversion of accumulated pulse	0.01 gal/pulse	0.05 gal/pulse	0.1 gal/pulse	0.5 gal/pulse	1 gal/pulse

Specifications: lead wire with M8 connector (ZS-40-A)

Items		Specifications
Conductor	Nominal cross section area	AWG23
	Outside diameter	Approx. 0.72 mm
Insulator	Outside diameter	Approx. 1.14 mm
	Colours	Brown, White, Black, Blue
Sheath	Outer diameter	φ3.4 mm

■ Characteristics graph

Measurable range of ethylene glycol aqueous solution (Reference value)

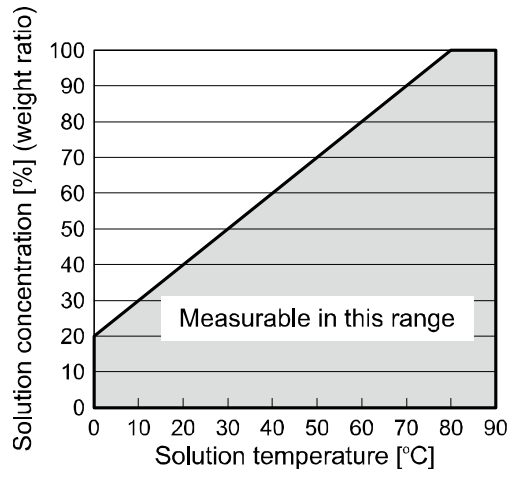

Flow characteristics (pressure loss: without flow adjustment valve)

PF3W704

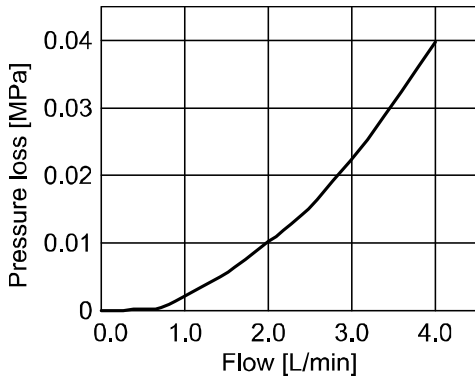

PF3W720

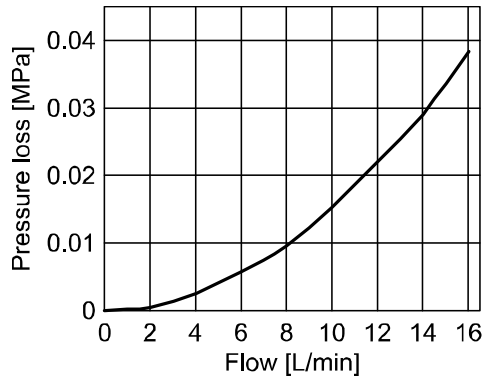

PF3W740

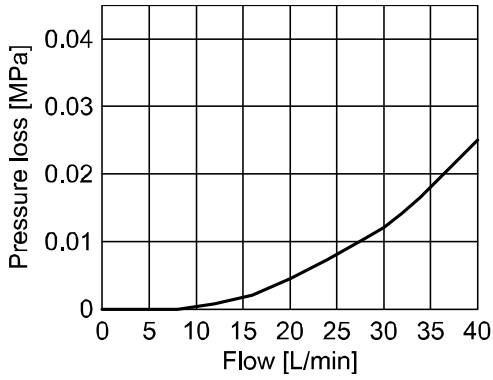

PF3W711

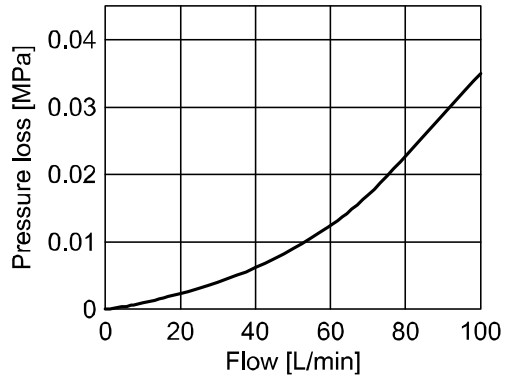

PF3W721

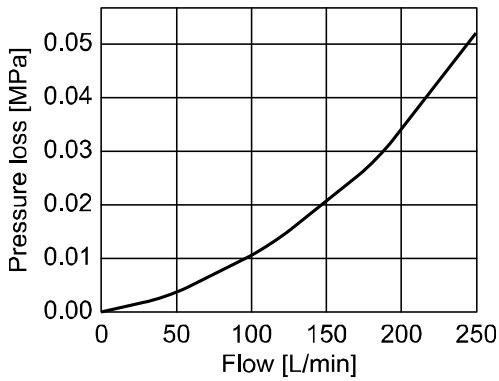

Operating pressure and proof pressure

PF3W704/720/740

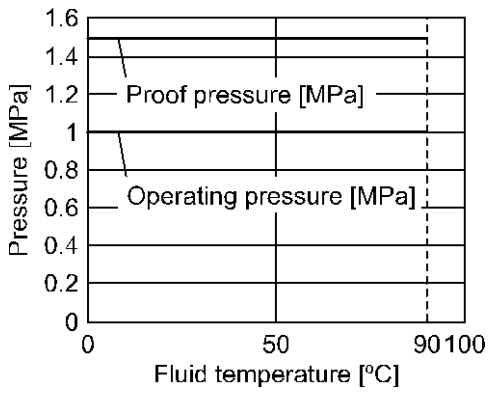

PF3W704S/720S/740S

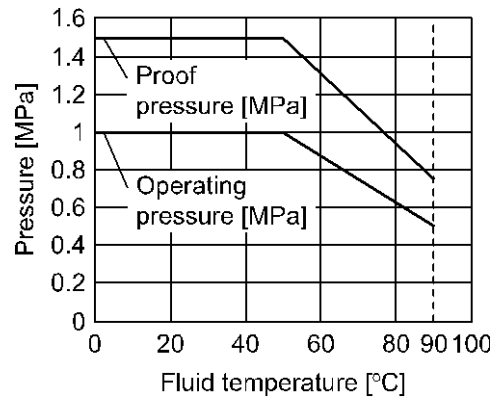

PF3W711

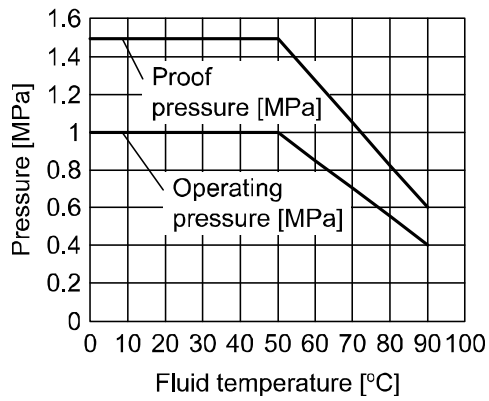

PF3W721

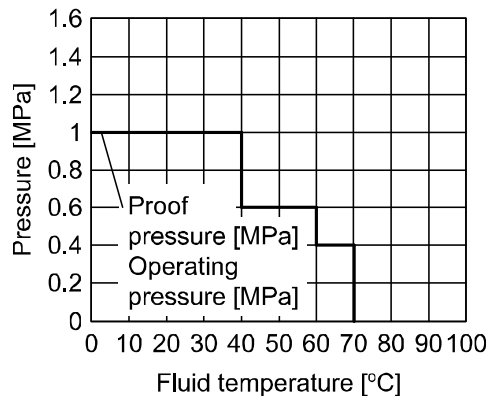

Straight inlet pipe length and accuracy (reference value)

- The smaller the piping size, the more the product is affected by the straight piping length.
- Fluid pressure has almost no effect.
- The smaller the flow rate, the less the product is affected by the straight piping length.
- The straight piping length shall be 8 cm or longer in order to maintain $\pm 3\%$ F.S. of the specification.
(For the 100 L/min types, the piping length should be 11 cm or longer.)

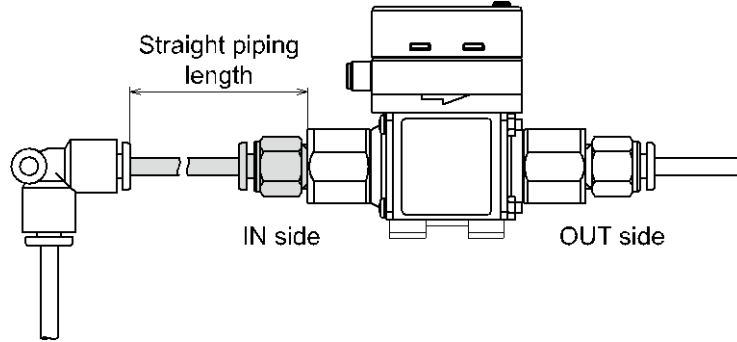

PF3W704

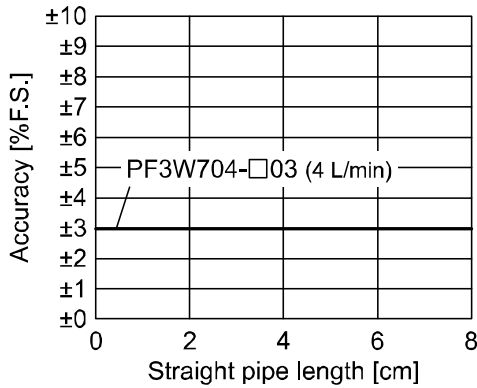

PF3W720

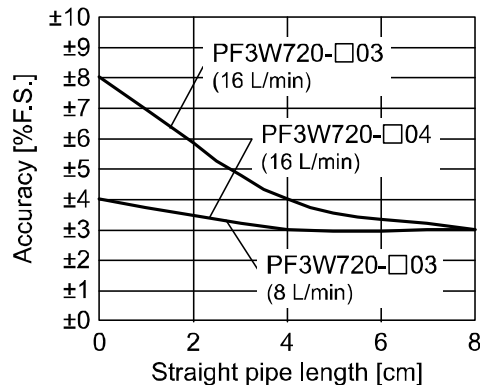

PF3W740

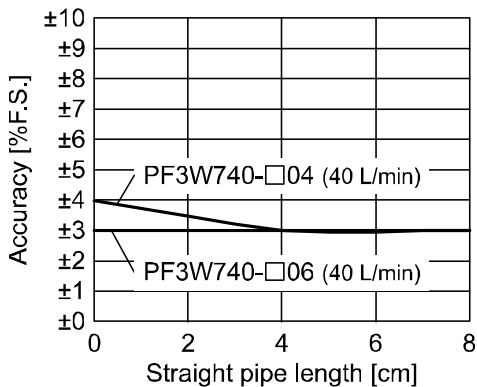

PF3W711

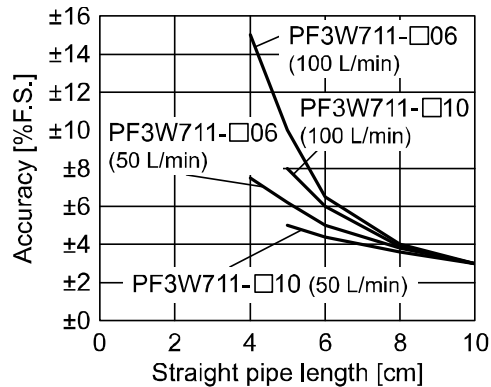

PF3W721

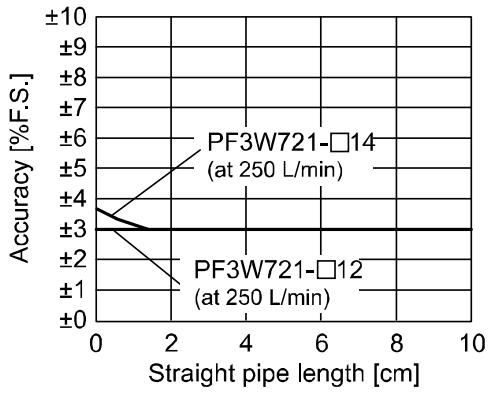

Flow characteristics of the flow rate adjustment valve

PF3W704S

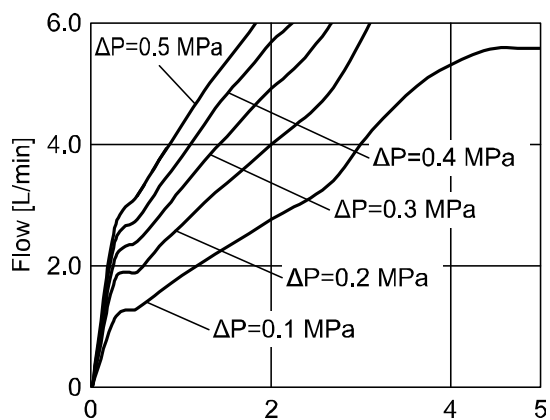

Number of rotations [turns]
 ΔP : Differential pressure between
 before and after the product

PF3W720S

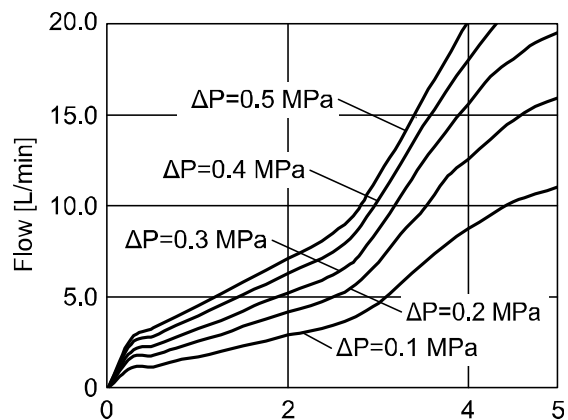

Number of rotations [turns]
 ΔP : Differential pressure between
 before and after the product

PF3W740S

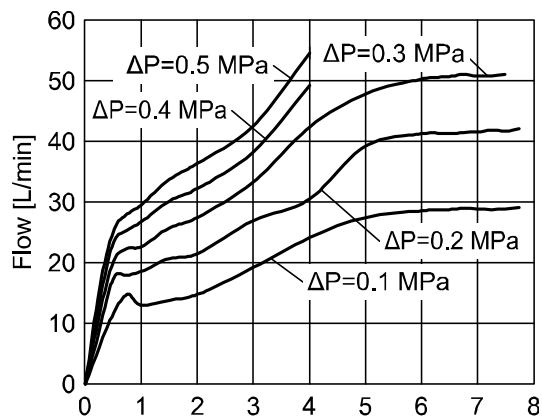

Number of rotations [turns]
 ΔP : Differential pressure between
 before and after the product

■Dimensions

PF3W704/720/740/711

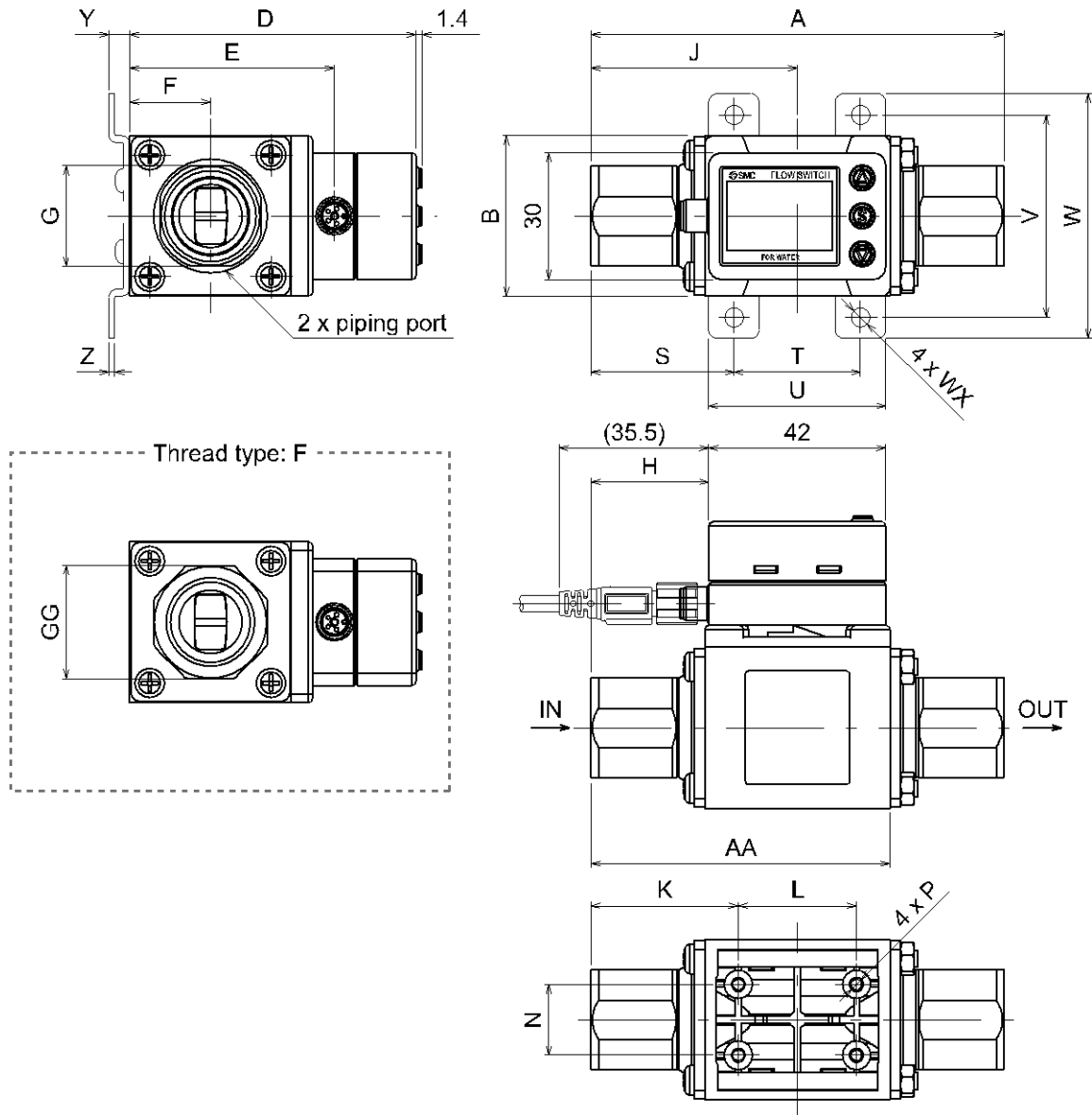

Basic type

Symbol Model	Piping port size	A	AA	B	D	E	F	H	J	K	L	N	P
PF3W704	3/8	70	50	30	66	40.6	15.2	14	35	26	18	13.6	φ2.7 depth 14
PF3W720	3/8, 1/2	78	54	30	66	40.6	15.2	18	39	30	18	13.6	φ2.7 depth 12
PF3W740	1/2, 3/4	98	71	38	68	48.6	19.2	28	49	35	28	16.8	φ2.7 depth 12
PF3W711	3/4, 1	124	92	46	77	57.6	23	42	63	48	28	18	φ3.5 depth 14

Symbol Model	Bracket dimensions							
	S	T	U	V	W	WX	Y	Z
PF3W704	24	22	32	40	50	4.5	5	1.5
PF3W720	28	22	32	40	50	4.5	5	1.5
PF3W740	34	30	42	48	58	4.5	5	1.5
PF3W711	44	36	48	58	70	5.5	7	2

Symbol Model	Piping port size	G	
		G	GG
PF3W704	3/8	20.9	23.9
PF3W720	3/8, 1/2	20.9, 23.9	23.9, 26.9
PF3W740	1/2, 3/4	23.9, 29.9	26.9, 31.9
PF3W711	3/4, 1	41	

PF3W721

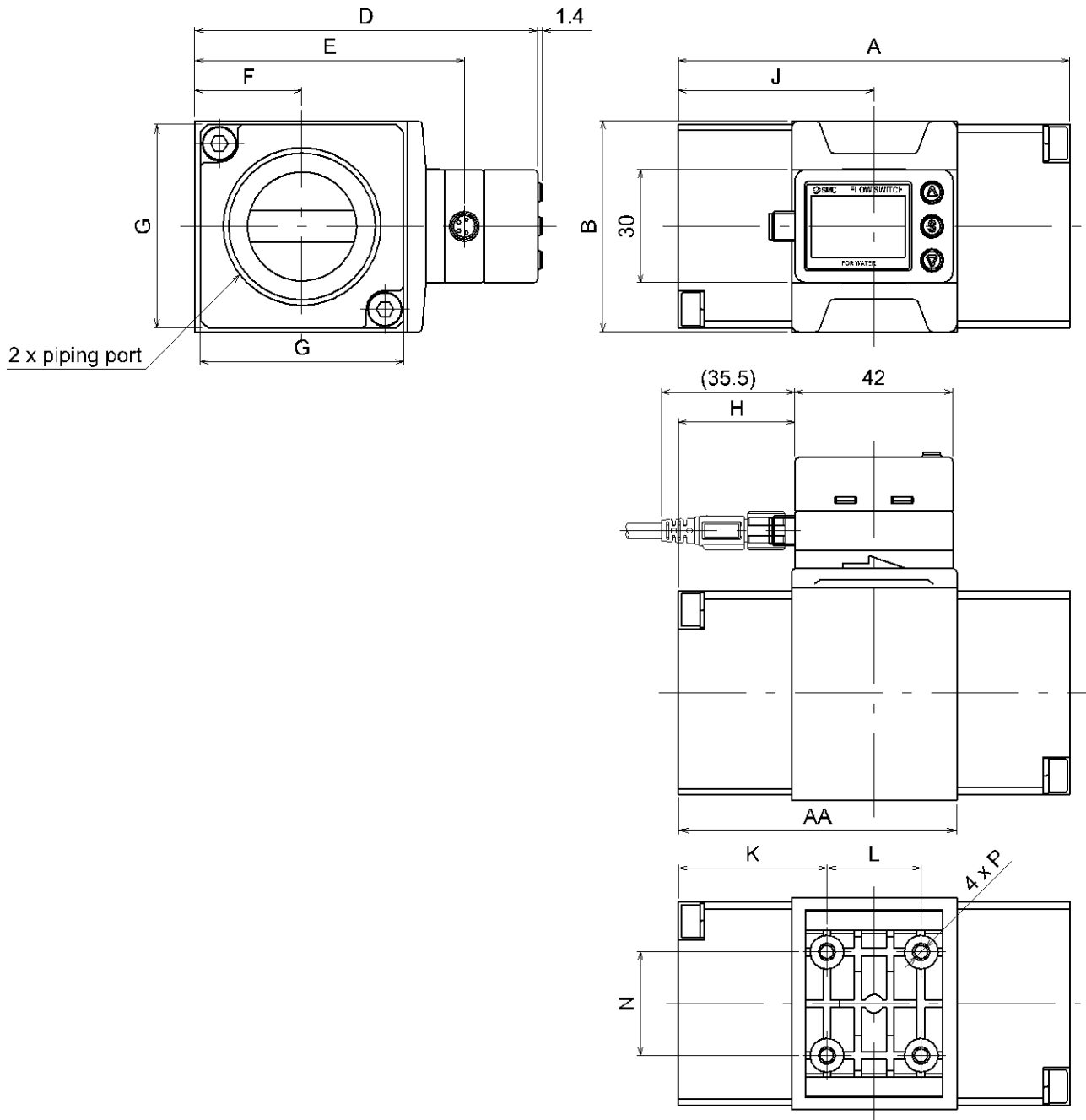

Basic type

Symbol Model	Piping port size	A	AA	B	D	E	F	G	H	J	K	L	N	P
PF3W721	1 1/4, 1 1/2	104	74	56	91	71.6	28.5	54	31	52	39.5	25	27.5	φ3.5 depth 14
	G 1 1/4	108	76						33	54	41.5			
	G 1 1/2	112	78						35	56	43.5			

PF3W704/720/740/711 (With temperature sensor)

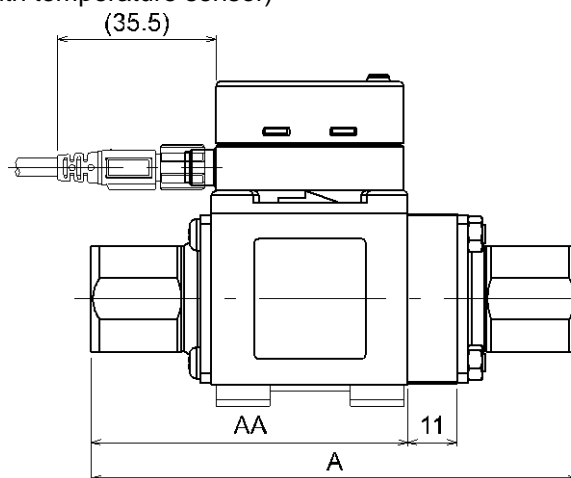

Temperature sensor

Model \ Symbol	A	AA
PF3W704-#-#T	81	50
PF3W720-#-#T	89	54
PF3W740-#-#T	109	71
PF3W711-#-#T	135	92
PF3W704-#-#T	115	74
PF3W721-F12-#T	119	76
PF3W721-F14-#T	123	78

PF3W704/720/740 (With flow adjustment valve)

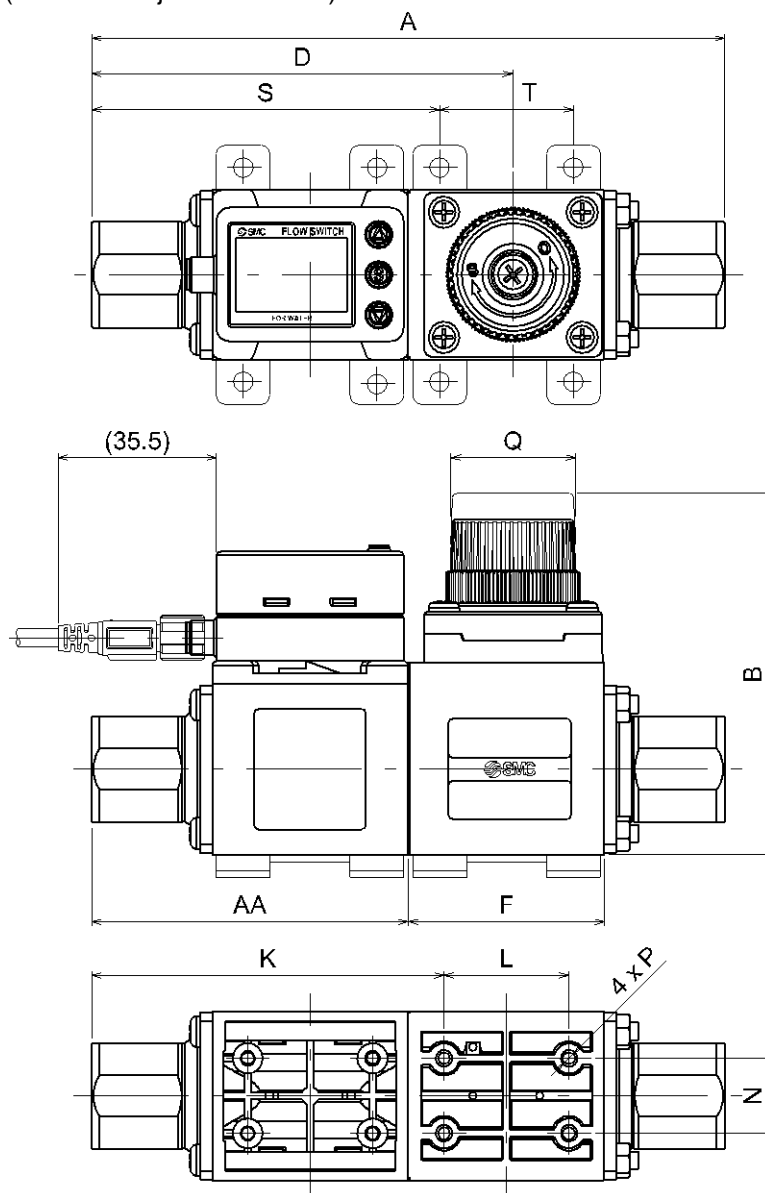

Basic type and flow adjustment valve

Symbol Model	A	AA	B	D	F	K	L	N	P	Q	Q: Number of rotations
PF3W704S	104	50	63.6 (Max. 68.6)	70.2	34	58.5	18	13.6	φ2.7 depth 10	φ19	6 turns
PF3W720S	112	54	63.6 (Max. 68.6)	74.2	34	62.5	18	13.6	φ2.7 depth 10	φ19	6 turns
PF3W740S	142	71	75.25 (Max. 81)	94.5	44	79	28	16.8	φ2.7 depth 10	φ28	7 turns

Symbol Model	Bracket dimensions	
	S	T
PF3W704S	56.5	22
PF3W720S	60.5	22
PF3W740S	78	30

PF3W704/720/740 (With temperature sensor and flow adjustment valve)

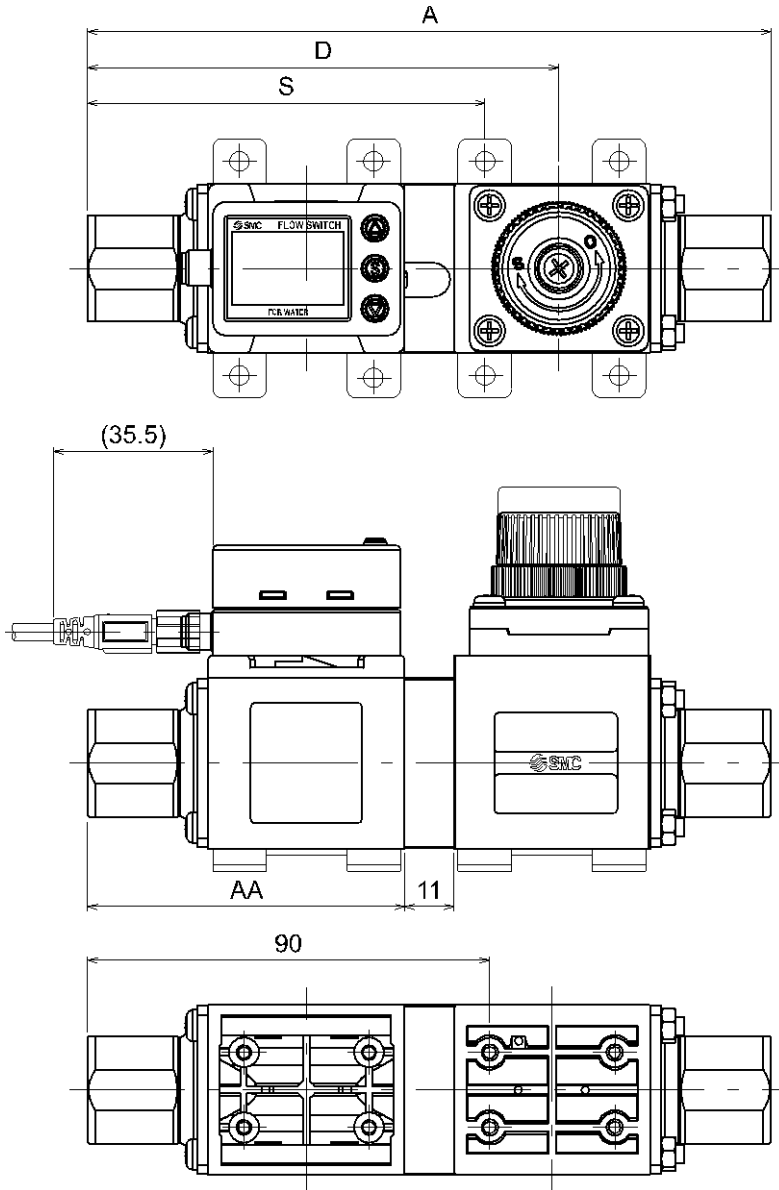

Basic type and flow adjustment valve and temperature sensor

Symbol	A	AA	D	K	S
Model					
PF3W704S-#-#T	115	50	81.2	69.5	67.5
PF3W720S-#-#T	123	54	85.2	73.5	71.5
PF3W740S-#-#T	153	71	105.5	90	89

Dimensions of rotating part of display

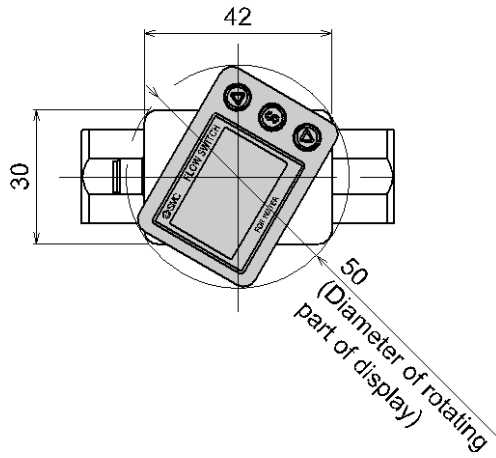

Dimensions of lead wire with M8 connector (ZS-40-A)

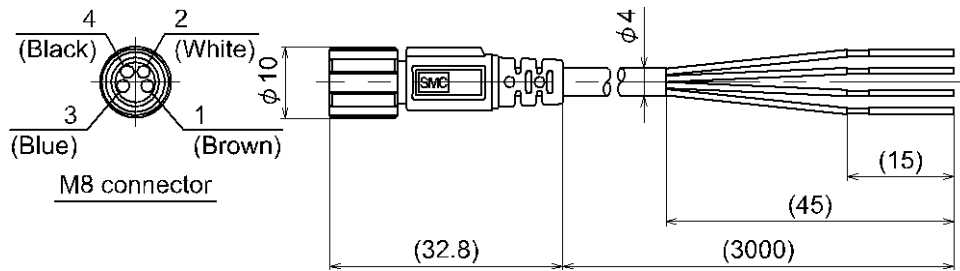

Dimensions of lead wire with M12-M8 connector (ZS-40-M12M8-A)

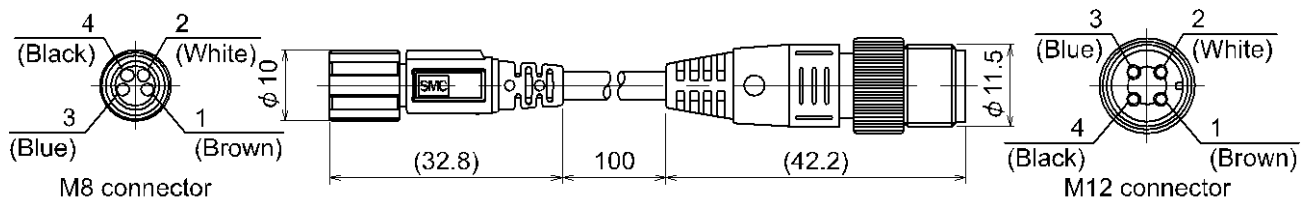

Revision history

A: Contents revised in several places
[September 2019]

SMC Corporation

4-14-1, Sotokanda, Chiyoda-ku, Tokyo 101-0021 JAPAN

Tel: + 81 3 5207 8249 Fax: +81 3 5298 5362

URL <https://www.smcworld.com>

Note: Specifications are subject to change without prior notice and any obligation on the part of the manufacturer.
© 2019 SMC Corporation All Rights Reserved

