



# Operation Manual

## PRODUCT NAME

4-channel Flow Monitor  
(Remote type monitor unit)

## MODEL / Series / Product Number

*PF2A20#*  
*PF2W20#*  
*PF2D20#*

**SMC Corporation**

## Table of Contents

Safety Instructions	2
Model Indication and How to Order	9
Summary of Product parts	12
Definition and terminology	13
Mounting and Installation	15
Installation	15
Wiring	16
Outline of setting	19
List of outputs	20
Initialize mode	21
Default settings	21
Setting procedure of Initialize mode	22
Function selection mode	26
Default settings	26
F_1 Input procedure of the Set value of instantaneous output	27
F_2 Input procedure of the Set value of accumulated output	28
F_3 Copy function	30
Other functions	31
Channel scan function	31
Peak/Bottom value display	31
Key-lock function	32
Maintenance	33
Troubleshooting	34
Cross-reference for troubleshooting	34
Error indication	36
Specification	37
Specifications	37
Dimensions	41



# Safety Instructions

These safety instructions are intended to prevent hazardous situations and/or equipment damage. These instructions indicate the level of potential hazard with the labels of "Caution", "Warning" or "Danger".

They are all important notes for safety and must be followed in addition to International Standards (ISO/IEC)\*1), and other safety regulations.

\*1) ISO 4414: Pneumatic fluid power -- General rules relating to systems.

ISO 4413: Hydraulic fluid power -- General rules relating to systems.

IEC 60204-1: Safety of machinery -- Electrical equipment of machines. (Part 1: General requirements)

ISO 10218: Manipulating industrial robots -Safety.

etc.



## Caution

**Caution** indicates a hazard with a low level of risk which, if not avoided, could result in minor or moderate injury.



## Warning

**Warning** indicates a hazard with a medium level of risk which, if not avoided, could result in death or serious injury.



## Danger

**Danger** indicates a hazard with a high level of risk which, if not avoided, will result in death or serious injury.

## Warning

### 1. The compatibility of the product is the responsibility of the person who designs the equipment or decides its specifications.

Since the product specified here is used under various operating conditions, its compatibility with specific equipment must be decided by the person who designs the equipment or decides its specifications based on necessary analysis and test results.

The expected performance and safety assurance of the equipment will be the responsibility of the person who has determined its compatibility with the product.

This person should also continuously review all specifications of the product referring to its latest catalog information, with a view to giving due consideration to any possibility of equipment failure when configuring the equipment.

### 2. Only personnel with appropriate training should operate machinery and equipment.

The product specified here may become unsafe if handled incorrectly.

The assembly, operation and maintenance of machines or equipment including our products must be performed by an operator who is appropriately trained and experienced.

### 3. Do not service or attempt to remove product and machinery/equipment until safety is confirmed.

1. The inspection and maintenance of machinery/equipment should only be performed after measures to prevent falling or runaway of the driven objects have been confirmed.

2. When the product is to be removed, confirm that the safety measures as mentioned above are implemented and the power from any appropriate source is cut, and read and understand the specific product precautions of all relevant products carefully.

3. Before machinery/equipment is restarted, take measures to prevent unexpected operation and malfunction.

### 4. Contact SMC beforehand and take special consideration of safety measures if the product is to be used in any of the following conditions.

1. Conditions and environments outside of the given specifications, or use outdoors or in a place exposed to direct sunlight.

2. Installation on equipment in conjunction with atomic energy, railways, air navigation, space, shipping, vehicles, military, medical treatment, combustion and recreation, or equipment in contact with food and beverages, emergency stop circuits, clutch and brake circuits in press applications, safety equipment or other applications unsuitable for the standard specifications described in the product catalog.

3. An application which could have negative effects on people, property, or animals requiring special safety analysis.

4. Use in an interlock circuit, which requires the provision of double interlock for possible failure by using a mechanical protective function, and periodical checks to confirm proper operation.



# Safety Instructions

## Caution

### **1. The product is provided for use in manufacturing industries.**

The product herein described is basically provided for peaceful use in manufacturing industries. If considering using the product in other industries, consult SMC beforehand and exchange specifications or a contract if necessary.  
If anything is unclear, contact your nearest sales branch.

## **Limited warranty and Disclaimer/Compliance Requirements**

The product used is subject to the following "Limited warranty and Disclaimer" and "Compliance Requirements".

Read and accept them before using the product.

### **Limited warranty and Disclaimer**

#### **1. The warranty period of the product is 1 year in service or 1.5 years after the product is delivered, whichever is first.\*2)**

Also, the product may have specified durability, running distance or replacement parts. Please consult your nearest sales branch.

#### **2. For any failure or damage reported within the warranty period which is clearly our responsibility, a replacement product or necessary parts will be provided.**

This limited warranty applies only to our product independently, and not to any other damage incurred due to the failure of the product.

#### **3. Prior to using SMC products, please read and understand the warranty terms and disclaimers noted in the specified catalog for the particular products.**

**\*2) Vacuum pads are excluded from this 1 year warranty.**

A vacuum pad is a consumable part, so it is warranted for a year after it is delivered. Also, even within the warranty period, the wear of a product due to the use of the vacuum pad or failure due to the deterioration of rubber material are not covered by the limited warranty.

### **Compliance Requirements**

#### **1. The use of SMC products with production equipment for the manufacture of weapons of mass destruction (WMD) or any other weapon is strictly prohibited.**

#### **2. The exports of SMC products or technology from one country to another are governed by the relevant security laws and regulation of the countries involved in the transaction. Prior to the shipment of a SMC product to another country, assure that all local rules governing that export are known and followed.**

## Caution

### **SMC products are not intended for use as instruments for legal metrology.**

Products that SMC manufactures or sells are not measurement instruments that are qualified by pattern approval tests relating to the measurement laws of each country. Therefore, SMC products cannot be used for business or certification ordained by the measurement laws of each country.

## Operator

- ◆ This operation manual is intended for those who have knowledge of machinery using pneumatic equipment, and have sufficient knowledge of assembly, operation and maintenance of such equipment. Only those persons are allowed to perform assembly, operation and maintenance.
- ◆ Read and understand this operation manual carefully before assembling, operating or providing maintenance to the product.

### ■ Safety Instructions

#### **Warning**

- Do not disassemble, modify (including changing the printed circuit board) or repair.  
An injury or failure can result.
- Do not operate the product outside of the specifications.  
Do not use for flammable or harmful fluids.  
Fire, malfunction, or damage to the product can result.  
Verify the specifications before use.
- Do not operate in an atmosphere containing flammable, explosive or corrosive gas.  
Fire, explosion or corrosion can result.  
This product is not designed to be explosion proof.
- Do not use the product in a place where static electricity is a problem.  
Otherwise it can cause failure or malfunction of the system.
- If using the product in an interlocking circuit:
  - Provide a double interlocking system, for example a mechanical system
  - Check the product regularly for proper operationOtherwise malfunction can result, causing an accident.
- The following instructions must be followed during maintenance:
  - Turn off the power supply
  - Ensure the flow is shut off before performing maintenanceOtherwise an injury can result.

## **Caution**

- Do not touch the terminals and connectors while the power is on.  
Otherwise electric shock, malfunction or damage to the product can result.
- Do not touch the piping or its connected parts when the fluid is at high temperature.  
It may lead to burnt.  
Ensure the piping cools sufficiently before touching.
- After maintenance is complete, perform appropriate functional inspections and leak tests.  
Stop operation if the equipment does not function properly or there is a leakage of fluid.  
When leakage occurs from parts other than the piping, the product might be faulty.  
Disconnect the power supply and stop the fluid supply.  
Do not apply fluid under leaking conditions.  
Safety cannot be assured in the case of unexpected malfunction.

### ■ NOTE

- Follow the instructions given below when designing, selecting and handling the product.
  - The instructions on design and selection (installation, wiring, environment, adjustment, operation, maintenance, etc.) described below must also be followed.
    - \*Product specifications
      - Use the specified voltage.  
Otherwise failure or malfunction can result.  
Insufficient supply voltage may not drive a load due to a voltage drop inside the product.  
Verify the operating voltage of the load before use.
      - Do not exceed the specified maximum allowable load.  
Otherwise it can cause damage or shorten the lifetime of the product.
      - Data stored by the product is not deleted, even if the power supply is cut off.  
(writing time: 1000000 cycles)
      - Reserve a space for maintenance.  
Allow sufficient space for maintenance when designing the system.

## ●Product handling

### \*Installation

- Do not apply excessive stress to the product when it is panel mounted.  
Otherwise damage to the product and disconnection from the panel mount can result.
- Ensure that the FG terminal is connected to ground when using a commercially available switch-mode power supply.
- Do not drop, hit or apply excessive shock to the product.  
Otherwise damage to the internal parts can result, causing malfunction.
- Do not pull the lead wire forcefully, not lift the product by pulling the lead wire. (Tensile force 49 N or less)  
Hold the product body when handling, to prevent damage, failure or malfunction.
- Limit of the power and output cable tensile force is 50 N, and limit of the sensor lead wire tensile force is 25 N.
- Never mount the product in a location that will be used as a foothold.  
The product may be damaged if excessive force is applied by stepping or climbing onto it.

### \*Wiring

- Do not pull the lead wires.  
In particular, never lift a product equipped with fitting and piping by holding the lead wires.  
Otherwise damage to the internal parts can result, causing malfunction or disconnection of the connector.
- Avoid repeatedly bending or stretching the lead wire, or placing heavy load on it.  
Repeated bending stress or tensile stress can cause damage to the sheath, or breakage of the wires.  
If the lead wire can move, fix it near the body of the product.  
The recommended bend radius of the lead wire is 6 times the outside diameter of the sheath, or 33 times the outside diameter of the wire insulation material, whichever is larger.  
Replace any damaged lead wire with a new one.
- Wire correctly.  
Incorrect wiring can damage the product.
- Do not perform wiring while the power is on.  
Otherwise damage to the internal parts can result, causing malfunction.
- Do not route wires and cables together with power or high voltage cables.  
Otherwise the product can malfunction due to interference or noise and surge voltage from power and high voltage cables.
- Confirm proper insulation of wiring.  
Poor insulation (interference from another circuit, poor insulation between terminals, etc.) can lead to excess voltage or current being applied to the product, causing damage.
- Keep wiring as short as possible to prevent interference from electromagnetic noise and surge voltage.  
Do not use a cable longer than 30 m.  
Wire the DC(-) line (blue) as close as possible to the power supply.
- When analogue output is used, install a noise filter (line noise filter, ferrite element, etc.) between the switch-mode power supply and this product.

#### \*Environment

- Do not use the product in an environment that is constantly exposed to the splash of water.  
Otherwise failure or malfunction can result. Take measures such as using a cover.
- Do not use the product in an environment where corrosive gases or fluids could be splashed.  
Otherwise damage to the product and malfunction can result.
- Do not use in a place where the product could be splashed by oil or chemicals.  
If the product is to be used in an environment containing oils or chemicals such as coolant or cleaning solvent, even for a short time, it may be adversely affected (damage, malfunction, or hardening of the lead wires).
- Do not use in an area where electrical surges are generated.  
If there is equipment generates a large electrical surge (solenoid type lifter, high frequency induction furnace, motor, etc.) close to the product, damage or failure of the internal circuit may occur. Take measures against the surge sources, and prevent the wires from coming into close contact.
- Do not use a load which generates surge voltage.  
When a surge-generating load such as a relay or solenoid is driven directly, use a product with a built-in surge absorbing element.
- The product is CE marked, but not immune to lightning strikes. Take measures against lightning strikes in the system.
- Do not use the product in areas that are exposed to vibration or impact.  
Otherwise failure or malfunction can result.
- Do not use the product in the presence of a magnetic field.  
This may lead to the malfunction of the product.
- Prevent foreign matter such as remnant of wires from entering the product.  
Otherwise failure or malfunction can result.
- Do not use the product in areas subject to large temperature cycle.  
Heating/cooling cycles other than ordinary changes in temperature can adversely affect the internal structure of the product
- Do not expose the product to direct sunlight.  
If using in a location directly exposed to sunlight, use a suitable protective cover.  
Otherwise failure or malfunction can result.
- Keep within the operating temperatures range.  
The operating temperature range is 0 to 50 °C.  
Operation below the minimum temperature limit may cause damage or operation failure due to frozen moisture in the fluid or air.  
Avoid sudden temperature changes even within the specified temperature range.
- Do not operate close to a heat source, or in a location exposed to radiant heat.  
Otherwise malfunction can result.



#### \*Adjustment and Operation

- Connect load before turning on the power.

- Do not short-circuit the load.

Although an error is displayed when the product load is short circuited, excess current may cause damage to the product.

- Do not press the setting buttons with a sharp pointed object.

This may damage the setting buttons.

- Supply the power when there is no flow.

- Check regulators and flow adjustment valves before introducing the fluid.

If pressure or flow rate beyond the specified range are applied to the sensor, the sensor unit may be damaged.

- Do not attempt to insert or pull the flow rate sensor or its connector when the power is on.

- The output is off for 3 seconds after power is supplied.

- Use settings suitable for the operating conditions.

Incorrect settings can cause operational failure.

(Refer to page 19 "Outline of setting")

- During the initial setting and any subsequent flow rate setting, the product will switch the output according to the existing settings until the changes are complete.

Confirm the output has no adverse effect on machinery and equipment before setting.

Stop the control system before setting if necessary.

- Do not touch the LCD during operation.

The display can vary due to static electricity.

#### \*Maintenance

- Perform regular maintenance and inspections.

There is a risk of unexpected malfunction of components due to the malfunction of equipment and machinery.

- Turn off the power supply, stop the fluid and check the safety before performing any maintenance.

There is a risk of unexpected malfunction.

- Do not use solvents such as benzene, thinner etc. to clean the product.

They could damage the surface of the body and erase the markings on the body.

Use a soft cloth to remove stains.

For heavy stains, use a cloth lightly dampened with diluted neutral detergent, then wipe up any residue with a dry cloth.

# Model indication and How to Order

**PF2A20**  -

For air

Remote type 4-channel monitor

Output specification

Symbol	Content
0	NPN (4 outputs)
1	PNP (4 outputs)

Option 2  
(Refer to page 10.)

Option 1  
(Refer to page 10.)

Unit specification

Symbol	Content
Nil	Unit selection function *1
M	SI unit only *2

\*1: Since the unit for Japan is fixed to SI due to new measurement law, this option is for overseas.  
\*2: Fixed unit Instantaneous flow: L/min  
Accumulated flow: L

**PF2W20**  -

For water

Remote type 4-channel monitor

Output specification

Symbol	Content
0	NPN (4 outputs)
1	PNP (4 outputs)

Option 2  
(Refer to page 10.)

Option 1  
(Refer to page 10.)

Unit specification

Symbol	Content
Nil	Unit selection function *1
M	SI unit only *2

\*1: Since the unit for Japan is fixed to SI due to new measurement law, this option is for overseas.  
\*2: Fixed unit Instantaneous flow: L/min  
Accumulated flow: L

**PF2D20**  -

For deionized water and chemicals

Remote type 4-channel monitor

Output specification

Symbol	Content
0	NPN (4 outputs)
1	PNP (4 outputs)

Option 2  
(Refer to page 10.)

Option 1  
(Refer to page 10.)

Unit specification

Symbol	Content
Nil	Unit selection function *1
M	SI unit only *2

\*1: Since the unit for Japan is fixed to SI due to new measurement law, this option is for overseas.  
\*2: Fixed unit Instantaneous flow: L/min  
Accumulated flow: L

### Option 1

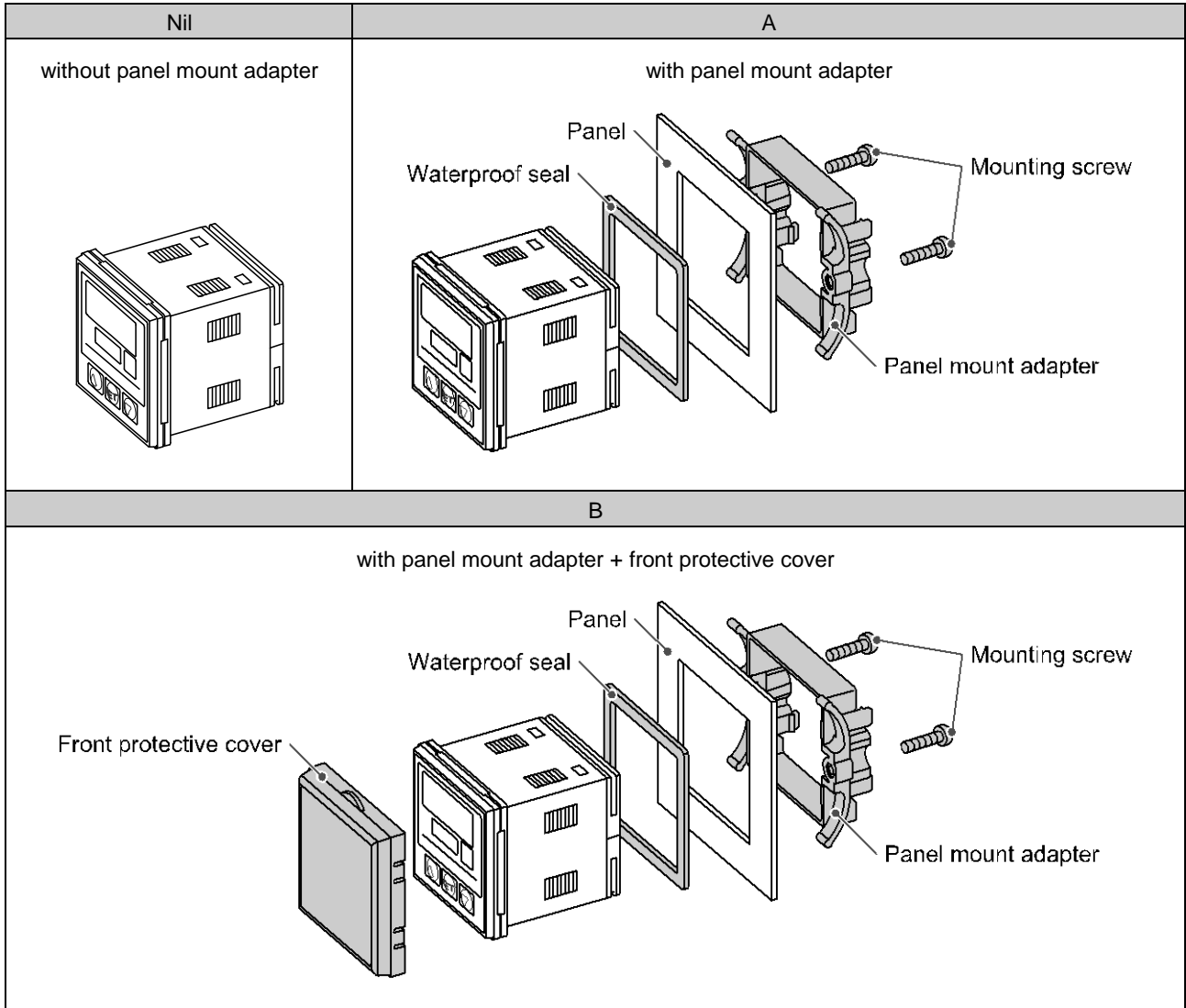

\*: Each accessory is not assembled with the product, but shipped together.

### Option 2

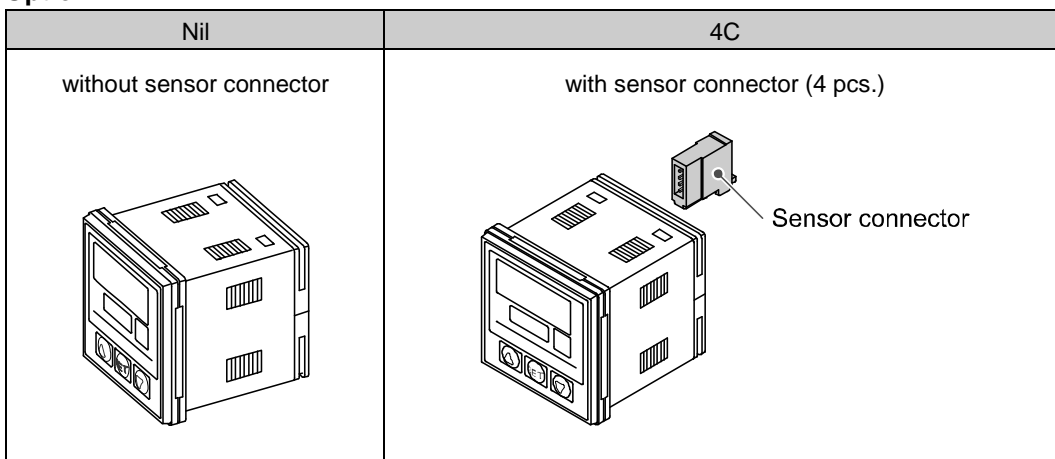

\*: Each accessory is not assembled with the product, but shipped together.

### Accessories/Part number

If an accessory is required separately, order using the following part numbers.

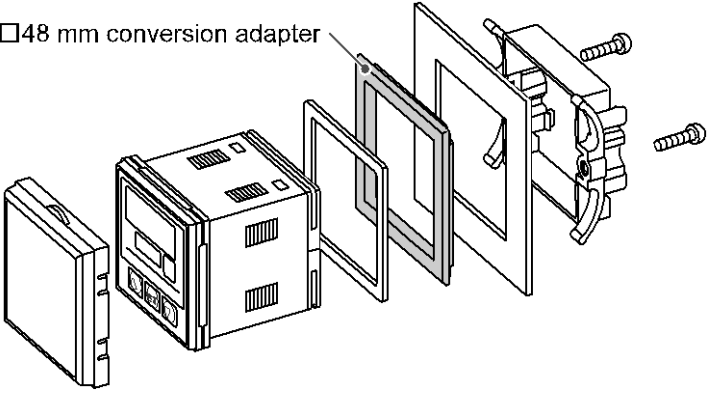
Part number	Description	Remarks	Weight
ZS-26-A	Power and output cable	Length: 2 m	65 g
ZS-26-B	Panel mount adapter	with waterproof seal, with Mounting screw (3.0 x 8 L) 2 pcs.	10 g
ZS-26-C	Panel mount adapter + front protective cover	with waterproof seal, with Mounting screw (3.0 x 8 L) 2 pcs.	15 g
ZS-26-01	Front protective cover only		5 g
ZS-26-D	□48 mm conversion adapter	<p>□48 mm conversion adapter</p>  <p>The panel which hold is □48 can be mounted to □36 by using the adapter.</p>	5 g
ZS-28-CA-4	Sensor connector for PF2A5□□, PF2W5□□, PF3W5□□ (e-con)	1 pc, Finished O.D.: φ1.15 to φ1.35, Cover colour: Blue	2 g
ZS-28-CA-2	Sensor connector for PF2D5□□ (e-con)	1 pc, Finished O.D.: φ0.9 to φ1.0, Cover colour: Red	2 g

# Summary of Product parts

## Front

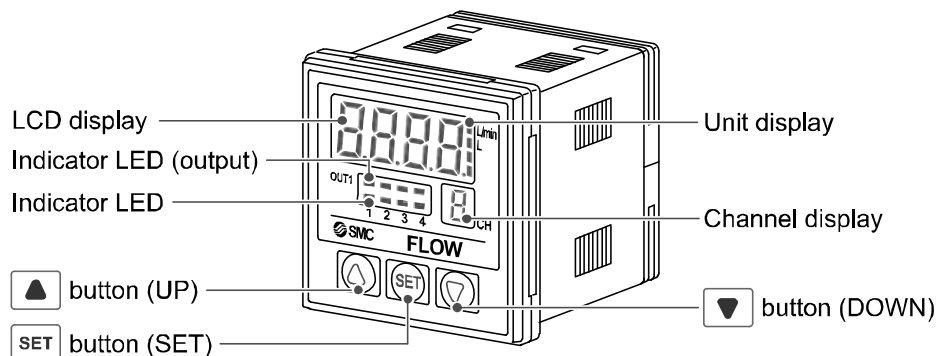

Item	Description
Unit display	Indicates the unit currently selected, and automatically displays instantaneous flow or accumulated flow units according to the display mode.
LCD display	Displays the flow value, setting mode, and error indication.
Indicator LED (output)	Indicates the switch output status. LED is ON when the output is ON.
Indicator LED *	Indicates the reference condition selected. LED is ON (Red) when normal condition is selected. (Only the PF2A□□)
Channel display	Indicates the channel selected (CH1 to CH4).
▲ button (UP)	Selects the mode or increases the ON/OFF Set value.
SET button (SET)	Press this button to change the mode and to set a value.
▼ button (DOWN)	Selects the mode or decreases the ON/OFF Set value.

\*: Operate only the PF2A2□□ series.

## Back

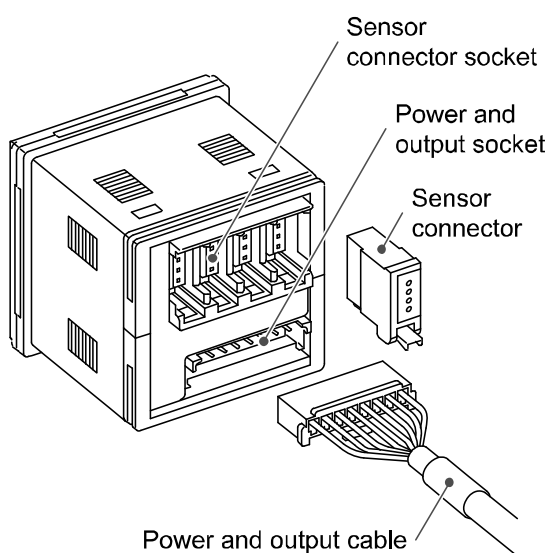

### Sensor connector pin numbers (on the product)

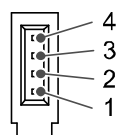

1	DC(+)	Brown
2	N.C.	
3	DC(-)	Blue
4	Sensor input (1 to 5 V)	White (PF2□5□□)
		Black (PF3W5□□)

### Power and output connector pin numbers (on the product)

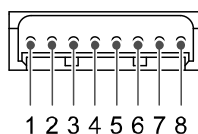

1	DC(+)
2	DC(-)
3	CH1_OUT1
4	N.C.
5	CH2_OUT1
6	CH3_OUT1
7	CH4_OUT1
8	N.C.

Item	Description
Sensor connector socket	Socket for the sensor connection.
Power and output socket	Socket for the power and output connection.
Sensor connector	Connector for attaching (crimping) to the sensor lead wire.
Power and output cable	Cable to supply power to the product and transmit outputs.

## ■ Definition and terminology

	Terms	Meaning
A	Accumulated flow	The total amount of fluid that has passed through the device. If an instantaneous flow of 10 L/min continues for 5 minutes, the accumulated flow will be $5 \times 10 = 50$ L.
	Accumulated pulse output	A type of output where a pulse is generated every time a predefined accumulated flow passes. It is possible to calculate the total accumulated flow by counting the pulses.
	Analogue output	Outputs a value proportional to the flow rate. When the analogue output is in the range 1 to 5 V, it will vary between 1 to 5 V according to the rate of flow. The same for analogue output of 4 to 20 mA.
C	Chattering	The problem of the switch output turning ON and OFF repeatedly around the Set value at high frequency due to the effect of pulsation.
D	Digit	Minimum unit for setting/display is 1 digit. When the minimum unit for setting/display is 5 L/min, 3 digits will be $3 \times 5 = 15$ L/min
	Display flow range	The range that which can be displayed by the product with a digital display.
F	F.S. (Full span, Full scale)	Stands for "full span" or "full scale", and indicates varied analogue output range at rated value. For example, when analogue output is 1 to 5 V, F.S. = $5[V] - 1[V] = 4[V]$ , (ref. $1\%F.S. = 4[V] \times 1\% = 0.04[V]$ )
H	Hysteresis	The difference between ON and OFF points used to prevent chattering. Hysteresis can be effective in avoiding the effects of pulsation.
	Hysteresis mode	Mode where the switch output will turn ON when the flow is greater than the Set value, and will turn OFF when the flow falls below the Set value – hysteresis value.
I	Instantaneous flow	The flow passing per unit of time. If it is 10 L/min, there is a flow of 10 L passing through the device in 1 minute.
	Internal voltage drop	The voltage drop across the product (and therefore not applied to the load), when the switch output is ON. The voltage drop will vary with load current, and ideally should be 0 V.
M	Minimum setting/display unit	The resolution of set and display values. If the minimum setting unit is 1 L/min, the display will change in 1 L/min steps, e.g. 10.....11.....12 L/min.
O	Operating humidity range	The ambient humidity range within which the product will meet all published specifications.
	Operating temperature range	The ambient temperature range within which the product will meet all published specifications.
R	Rated flow range	The flow range within which the product will meet all published specifications.
	Rated pressure range	The pressure range within which the product will meet all published specifications.
	Repeatability	Reproducibility of the display or analogue output value, when the measured quantity is repeatedly increased and decreased.
	Response time	Time from when the target flow is applied until the flow reaches 90% of the Set value.

	Terms	Meaning
S	Setting flow range	The range of ON/OFF threshold values that can be set for those products with a switch output.
	Switch output	Output type that has only 2 conditions, ON or OFF. In the ON condition, an indicator light (output) will show, and any connected load will be powered. In the OFF condition, there will be no indicator (output) and no power supplied to the load.
T	Temperature characteristics	The amount of variation in the analogue output or display value when ambient temperature is changed.
U	Unit selection function	A function to select display units other than the international unit (SI unit) specified in the new Japanese measurement law. Flow can only be displayed by SI units in Japan.
W	Window comparator mode	An operating mode in which the switch output is turned on and off depending on whether the flow is inside or outside the range of two Set values.

# Mounting and Installation

## ■ Installation

- Never mount the product in a location that will be used as a foothold.

## ● Installing

### Mounting with the panel mount adapter

- Install the product as shown below. The □48 mm conversion adapter is available if required.
- The panel mount adapter and the front cover can be rotated 90° for mounting.
- Fix the panel mount adapter to the product with the mounting screws (nominal size: 3 x 8 L, 2 pcs.) supplied.
- The front protective cover for panel mounting satisfies IP65 (when □48 mm conversion adapter is used, it satisfies IP40). However, if the panel mount adapter is not fixed securely or the instrument is not seated correctly, water might enter. After the product makes contact with the panel, the screws should be further tightened 1/4 to 1/2 turn.
- The self tapping screws cannot be re-used.
- The product can be mounted on a panel with a thickness of 0.5 to 8 mm.
- Refer to the dimension drawing (page 42) for panel cut-out dimensions.

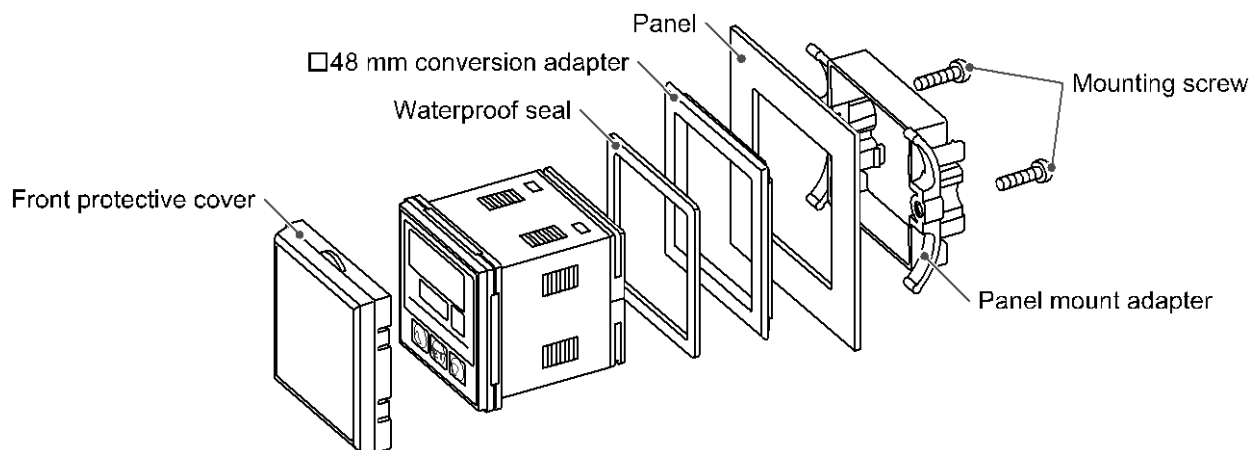

### Removing the panel mount adapter

- The product with panel mount adapter can be removed from the installation by removing 2 screws and releasing the hooks at the sides. The hooks can be released by inserting a suitable thin card.
- Pull the panel mount adapter to the front, and remove the product.
- If the panel mount adapter is pulled with the hook engaged, the product or the panel mount adapter will be damaged.

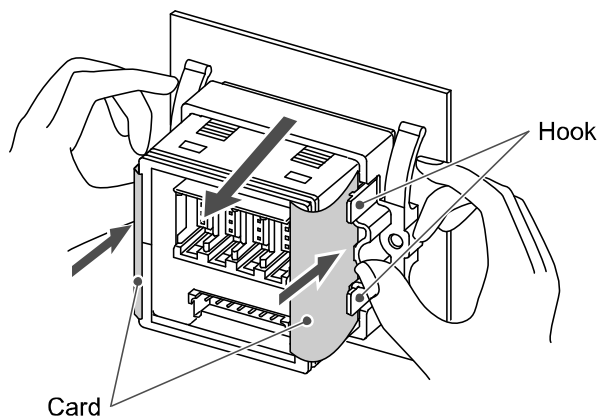



## ■Wiring

- Connections should only be made with the power supply turned off.
- Use separate routes for the product wiring and any power or high voltage wiring. Otherwise, malfunction may result due to noise.
- Ensure that the FG terminal is connected to ground when using a commercially available switch-mode power supply. When a switch-mode power supply is connected to the product, switching noise will be superimposed and the product specification can no longer be met. This can be prevented by inserting a noise filter, such as a line noise filter and ferrite core, between the switch-mode power supply and the product, or by using a series power supply instead of a switch-mode power supply.

### ●Connecting the wiring

#### Attaching the sensor connector to the sensor wire

- Strip the sensor wire as shown. Do not cut the insulator.

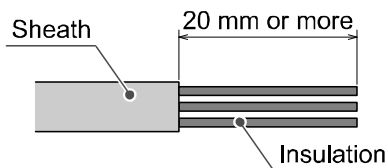

- Insert the corresponding wire colour shown in the table into the pin number printed on the sensor connector, to the bottom.

Pin number on connector	Wire colour (PF2□5□□)	Wire colour (PF3W5□□)
1	Brown	Brown
2	(N.C.)	(N.C.)
3	Blue	Blue
4	White	Black

- Check that the above preparation has been performed correctly, then part A shown should be pressed in by hand to make temporary connection.

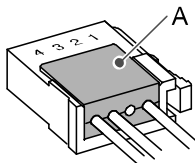

- Part A should then be pressed in using a suitable tool, such as pliers.

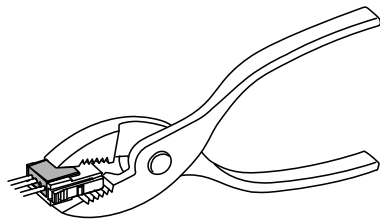

- The sensor connector cannot be re-used once it has been fully crimped. In cases of connection failure such as incorrect order of wires or incomplete insertion, please use the new connector.
- If the sensor is not connected correctly, [---] will be displayed.

## Connecting/Disconnecting

- When connecting, insert the connectors straight into the body until it clicks.
- When removing the connector, press down the lever to release the hook from the housing and pull the connector straight out.

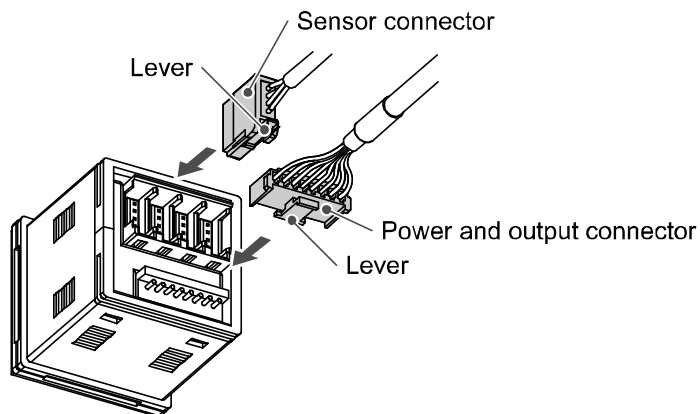

### Power and output connector pin numbers (on the cable)

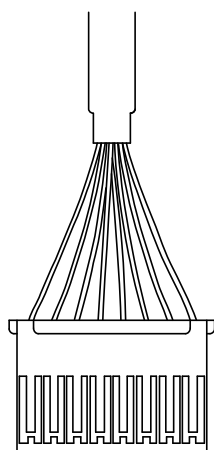

Pin no.	Description	Wire cable
1	DC(+)	Brown
2	DC(-)	Blue
3	CH1_OUT1	Black
4	N.C.	White
5	CH2_OUT1	Grey
6	CH3_OUT1	Red
7	CH4_OUT1	Green
8	N.C.	Yellow

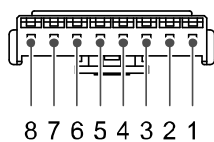

### Sensor connector pin numbers (on the cable)

- with PF2□5□□

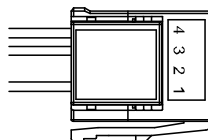

Pin no.	Description	Wire cable
1	DC(+)	Brown
2	N.C.	
3	DC(-)	Blue
4	Sensor input (1 to 5 V)	White

- with PF3W5□□

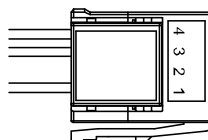

Pin no.	Description	Wire cable
1	DC(+)	Brown
2	N.C.	
3	DC(-)	Blue
4	Sensor input (1 to 5 V)	Black

● Internal circuit and wiring example

When the Power and output cable (ZS-26-A) is used, the wire colours will apply as shown in the diagram.

**NPN (4 outputs) type**

PF2A200-□□□□

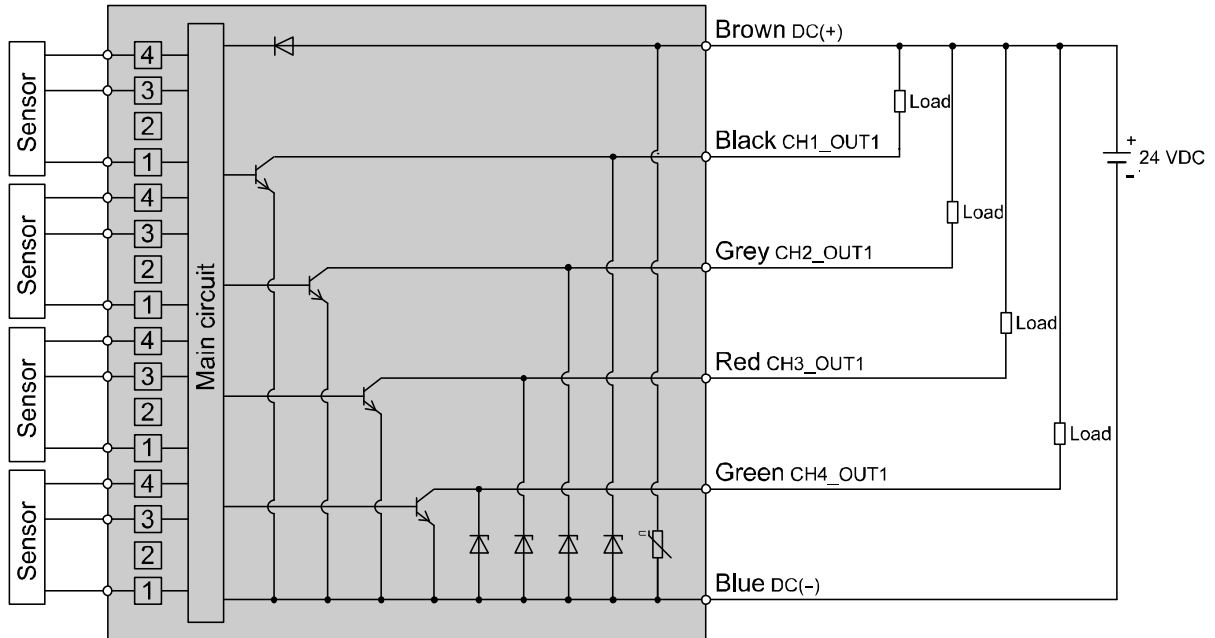

Max. 30 V, 80 mA

Internal voltage drop: 1 V or less

**PNP (4 outputs) type**

PF2A201-□□□□

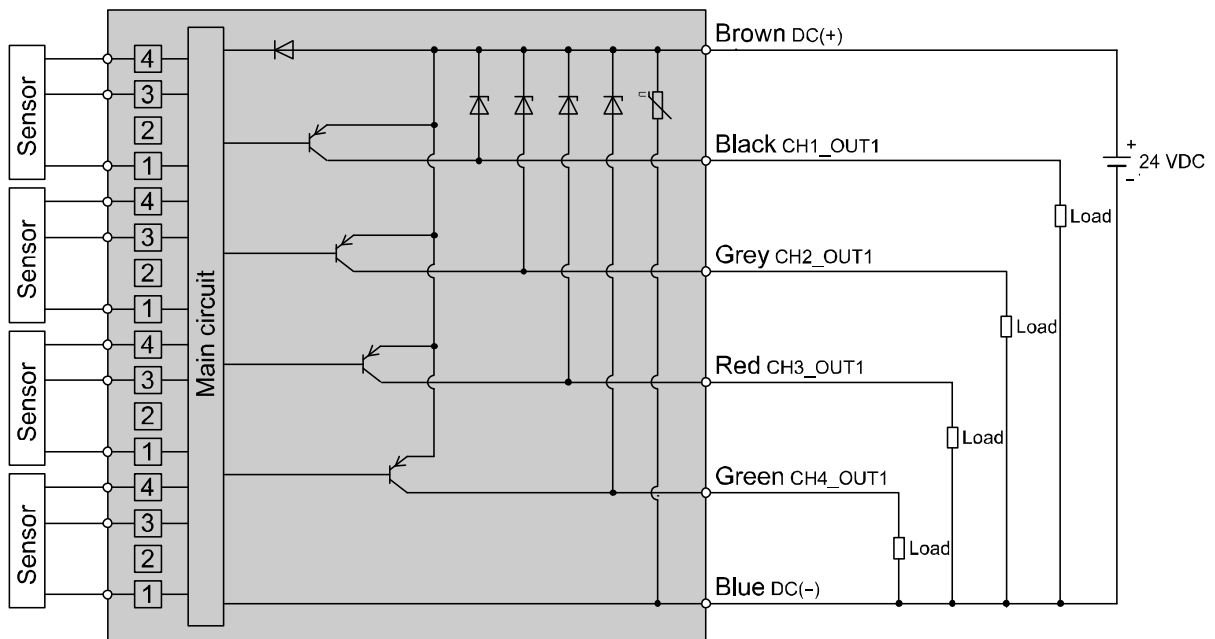

Max. 80 mA

Internal voltage drop: 1.5 V or less

## Outline of setting

### Power is supplied



The output will not operate for 3 seconds after supplying power.  
The identification code of the product is displayed.





### Measurement mode



The mode in which the flow is detected and displayed, and the switch output is operating. This is the basic operating mode; and other modes should be selected for setting changes and other function settings.



Each time the  button is pressed, a channel is selected "1 → 2 → 3 → 4 → 1 → ...". The flow value will be displayed for each channel selected.

Press the  button to select either instantaneous flow or accumulated flow.

The display of instantaneous flow and accumulated flow can be changed while the  button is pressed.

While pressing the  button during the display of accumulated flow, the accumulation can be started/stopped by pressing the  button.

  button  
press  
for 2 sec.

  button  
press.



### Initialize mode

(Refer to page 21)

Items below can be set.

- Connected sensor
- Display mode
- Unit selection function \*1
- Output mode
- Switch operation
- Reference condition \*2

### Function selection mode

(Refer to page 26)

Items below can be set.

- [F\_1]  
Input the Set value of instantaneous output
- [F\_2]  
Input the Set value of accumulated output
- [F\_3] Copy function

### Other functions

(Refer to page 31)

Items below can be set.

- Channel scan function
- Peak/Bottom value display
- Key-lock function

\*1: Operate only the product with unit selection function.

\*2: Operate only the PF2A2□□ series.

## ■ List of outputs

Find the diagram of the output required in the table below. Perform settings following the Set value column on the right.

	Switch output diagram	Output mode	Switch operation	Set value
Instantaneous flow		Instantaneous output mode <div style="border: 1px solid black; padding: 2px; display: inline-block;">010</div>	Non-Reverse output <div style="border: 1px solid black; padding: 2px; display: inline-block;">LP</div>	Set point 2 $\leq$ Set point 1 <sup>*2</sup> <div style="border: 1px solid black; padding: 2px; display: inline-block;">P_2</div> $\leq$ <div style="border: 1px solid black; padding: 2px; display: inline-block;">P_1</div> <sup>*2</sup> Hysteresis mode
				Set point 1 $<$ Set point 2 <div style="border: 1px solid black; padding: 2px; display: inline-block;">P_1</div> $<$ <div style="border: 1px solid black; padding: 2px; display: inline-block;">P_2</div> Window comparator mode
				Set point 2 $\leq$ Set point 1 <sup>*2</sup> <div style="border: 1px solid black; padding: 2px; display: inline-block;">n_2</div> $\leq$ <div style="border: 1px solid black; padding: 2px; display: inline-block;">n_1</div> <sup>*2</sup> Hysteresis mode
				Set point 1 $<$ Set point 2 <div style="border: 1px solid black; padding: 2px; display: inline-block;">n_1</div> $<$ <div style="border: 1px solid black; padding: 2px; display: inline-block;">n_2</div> Window comparator mode
Accumulated flow		Accumulated output mode <div style="border: 1px solid black; padding: 2px; display: inline-block;">011</div>	Non-Reverse output <div style="border: 1px solid black; padding: 2px; display: inline-block;">LP</div>	Upper 3 digits + Lower 3 digits <div style="border: 1px solid black; padding: 2px; display: inline-block;">1PH</div> + <div style="border: 1px solid black; padding: 2px; display: inline-block;">1PL</div>
				Upper 3 digits + Lower 3 digits <div style="border: 1px solid black; padding: 2px; display: inline-block;">1nH</div> + <div style="border: 1px solid black; padding: 2px; display: inline-block;">1nL</div>
Accumulated pulse		Accumulated pulse output mode <div style="border: 1px solid black; padding: 2px; display: inline-block;">012</div>	Non-Reverse output <div style="border: 1px solid black; padding: 2px; display: inline-block;">LP</div>	No Set value input
				Reverse output <div style="border: 1px solid black; padding: 2px; display: inline-block;">Ln</div>

\*1: In window comparator mode, the hysteresis is fixed at 3 digits. When setting, allow 7 digits or more between Set point 1 and Set point 2.

\*2: When Set point 1 = Set point 2, chattering may occur.

## Initialize mode

### ■ Default settings

#### ● PF2A20□ series

Item	Default settings	Page
Selection of the connected sensor	[10L] 1 to 10 L/min type (PF2A510)	Page 22
Selection of display mode	[d_1] Display instantaneous flow	Page 23
Unit selection function *	[U_1] L/min	
Selection of output mode	[o10] Instantaneous output mode	Page 24
Selection of switch operation	[1_n] Reverse output	
Selection of reference condition	[Anr] Standard condition	

\*: Operate only the product with unit selection function.

#### ● PF2W20□ series

Item	Default settings	Page
Selection of the connected sensor	[04L] 0.5 to 4 L/min type (PF2W504) (PF3W504)	Page 22
Selection of display mode	[d_1] Display instantaneous flow	Page 23
Unit selection function *	[U_1] L/min	
Selection of output mode	[o10] Instantaneous output mode	Page 24
Selection of switch operation	[1_n] Reverse output	

\*: Operate only the product with unit selection function.

#### ● PF2D20□ series

Item	Default settings	Page
Selection of the connected sensor	[04d] 0.4 to 4 L/min type (PF2D504)	Page 22
Selection of display mode	[d_1] Display instantaneous flow	Page 23
Unit selection function *	[U_1] L/min	
Selection of output mode	[o10] Instantaneous output mode	Page 24
Selection of switch operation	[1_n] Reverse output	

\*: Operate only the product with unit selection function.

## ■ Setting procedure of Initialize mode

<Operation>

Press the  button in measurement mode to select the channel to be set.

Press the  button for 2 seconds or longer.

### Selection of the connected sensor

The sensor to be connected is selectable before using the product.

If the select connected sensor is changed, the accumulated value and the peak (bottom) value display are return to default setting.

Press the  button to select.

#### •PF2A20□ series

- [10L]: 1 to 10 L/min type (PF2A510)
- [50L]: 5 to 50 L/min type (PF2A550)
- [11L]: 10 to 100 L/min type (PF2A511)
- [21L]: 20 to 200 L/min type (PF2A521)
- [51L]: 50 to 500 L/min type (PF2A551)

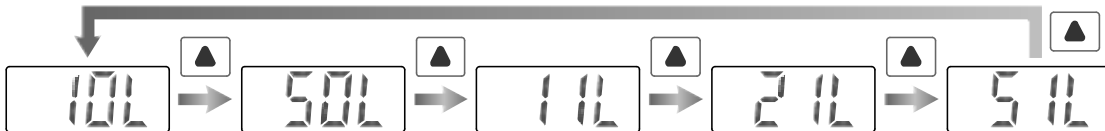

#### •PF2W20□ series

- [04L]: 0.5 to 4 L/min type (PF2W504) (PF3W504)
- [20L]: 2 to 16 L/min type (PF2W520) (PF3W520)
- [40L]: 5 to 40 L/min type (PF2W540) (PF3W540)
- [11L]: 10 to 100 L/min type (PF2W511) (PF3W511)

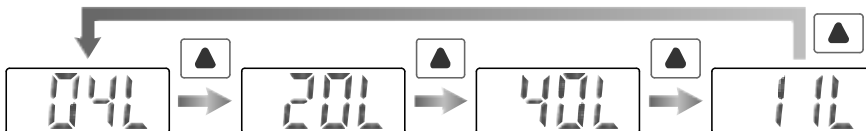

\*: Flow display is available for PF3W5 series. Temperature display (Model indication: with T) is not available.

#### •PF2D20□ series

- [04d]: 0.4 to 4 L/min type (PF2D504)
- [20d]: 1.8 to 20 L/min type (PF2D520)
- [40d]: 4 to 40 L/min type (PF2D540)

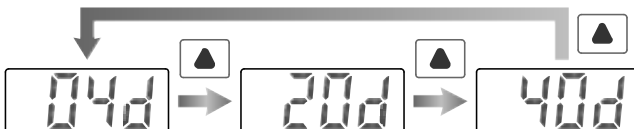

↓ Press the  button. (continued)

### Selection of display mode

Select the display of instantaneous flow or accumulated flow.

Press the  button to select.

- [d\_1]: display instantaneous flow
- [d\_2]: display accumulated flow

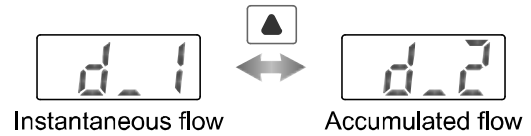

The product with unit selection function

Press the  button.

SI unit only

### Selection of unit selection function

The display unit can only be selected for products with unit selection function.

Press the  button to select.

#### •PF2A20□ series

Display	Instantaneous flow	Accumulated flow
[U_1]	L/min	L
[U_2] *	CFM x 10 <sup>-2</sup> , CFM x 10 <sup>-1</sup>	ft <sup>3</sup> x 10 <sup>-1</sup> , ft <sup>3</sup> x 10 <sup>-2</sup>

#### •PF2W20□ series

Display	Instantaneous flow	Accumulated flow
[U_1]	L/min	L
[U_2] *	gal(US)/min	gal(US)

#### •PF2D20□ series

Display	Instantaneous flow	Accumulated flow
[U_1]	L/min	L
[U_2] *	gal(US)/min	gal(US)

\*: Refer to page 25 for the flow rate when [U\_2] is selected.

\*: Use the unit label included in the product, if necessary.



Press the  button.

### Selection of output mode

Select the switch output mode required referring to the list of outputs (page 20).

Press the  button to select.

- [o10]: Instantaneous output mode
- [o11]: Accumulated output mode
- [o12]: Accumulated pulse output mode

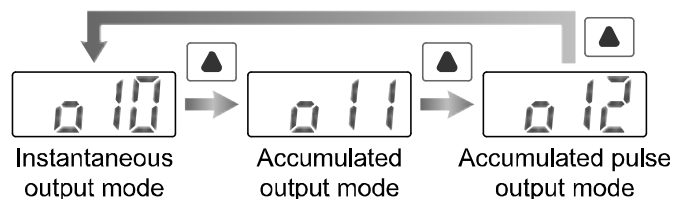

Press the  button. (continued)





### Selection of switch operation

Select the switch operation required referring to the list of outputs (page 20).

Press the  button to select.

- [1\_n]: Reverse output
- [1\_P]: Non-Reverse output



Reverse output



Non-Reverse output



Press the  button.

### Reference condition selection

Operate only the PF2A2□□ series.

Select standard condition or normal condition for the display units.

Press the  button to select.

- [ Anr]: Standard condition.  
Flow display which is converted in atmospheric pressure at 20 °C, 65%R.H.
- [ nor]: Normal condition.  
Flow display which is converted in atmospheric pressure at 0 °C.



Standard condition



Normal condition

\*: Flow rate in the specification is the value at standard condition.

If the display unit standard is changed from standard to normal, use the conversion formula.

Flow rate at standard condition x 0.927 = Flow rate at normal condition

\*: When [nor] is selected, an Indicator light (reference condition) appears.



Press the  button.

Setting of initialize mode is completed.  
Return to measurement mode.

Flow specification when [U\_2] is selected by the unit selection function

●PF2A20□ series

Model		PF2A20□					
Applicable sensor		PF2A510	PF2A550	PF2A511	PF2A521	PF2A551	
Flow	Rated flow range		3.5 to 35.5 CFM x 10 <sup>-2</sup>	18 to 176 CFM x 10 <sup>-2</sup>	3.5 to 35.5 CFM x 10 <sup>-1</sup>	7 to 71 CFM x 10 <sup>-1</sup>	18 to 176 CFM x 10 <sup>-1</sup>
	Instantaneous flow	Setting/display flow range *	1.0 to 38.5 CFM x 10 <sup>-2</sup>	8 to 186 CFM x 10 <sup>-2</sup>	1.0 to 38.0 CFM x 10 <sup>-1</sup>	2 to 76 CFM x 10 <sup>-1</sup>	8 to 186 CFM x 10 <sup>-1</sup>
		Min. setting/display unit	0.5 CFM x 10 <sup>-2</sup>	2.0 CFM x 10 <sup>-2</sup>	0.5 CFM x 10 <sup>-1</sup>	1.0 CFM x 10 <sup>-1</sup>	2.0 CFM x 10 <sup>-1</sup>
	Accumulated flow	Setting/display flow range	0 to 999999 ft <sup>3</sup> x 10 <sup>-2</sup>		0 to 999999 ft <sup>3</sup> x 10 <sup>-1</sup>		
		Min. setting/display unit	1 ft <sup>3</sup> x 10 <sup>-3</sup>		1 ft <sup>3</sup> x 10 <sup>-1</sup>		
Conversion of accumulated pulse		0.5 ft <sup>3</sup> x 10 <sup>-2</sup> /pulse	2.0 ft <sup>3</sup> x 10 <sup>-2</sup> /pulse	0.5 ft <sup>3</sup> x 10 <sup>-1</sup> /pulse	1.0 ft <sup>3</sup> x 10 <sup>-1</sup> /pulse	2.0 ft <sup>3</sup> x 10 <sup>-1</sup> /pulse	

\*: Flow rate in the specification is the value at standard condition.

If the display unit standard is changed from standard to normal, use the conversion formula.

Flow rate at standard condition x 0.927 = Flow rate at normal condition

●PF2W20□ series

Model		PF2W20□				
Applicable sensor		PF2W504	PF2W520	PF2W540	PF2W511	
		PF3W504	PF3W520	PF3W540	PF3W511	
Flow	Rated flow range		0.13 to 1.06 gal(US)/min	0.55 to 4.25 gal(US)/min	1.3 to 10.6 gal(US)/min	2.6 to 26.4 gal(US)/min
	Instantaneous flow	Setting/display flow range	0.10 to 1.16 gal(US)/min	0.40 to 4.75 gal(US)/min	1.0 to 11.6 gal(US)/min	7 to 110 gal(US)/min
		Min. setting/display unit	0.01 gal(US)/min	0.05 gal(US)/min	0.1 gal(US)/min	0.2 gal(US)/min
	Accumulated flow	Setting/display flow range	0 to 999999 gal(US)			
		Min. setting/display unit	1 gal(US)			
Conversion of accumulated pulse		0.01 gal(US)/pulse	0.05 gal(US)/pulse	0.1 gal(US)/pulse	0.2 gal(US)/pulse	

●PF2D20□ series

Model		PF2D20□			
Applicable sensor		PF2D504	PF2D520	PF2D540	
Flow	Rated flow range		0.11 to 1.06 gal(US)/min	0.40 to 5.30 gal(US)/min	1.1 to 10.6 gal(US)/min
	Instantaneous flow	Setting/display flow range	0.9 to 1.16 gal(US)/min	0.25 to 5.80 gal(US)/min	0.9 to 11.6 gal(US)/min
		Min. setting/display unit	0.01 gal(US)/min	0.05 gal(US)/min	0.1 gal(US)/min
	Accumulated flow	Setting/display flow range	0 to 999999 gal(US)		
		Min. setting/display unit	1 gal(US)		
Conversion of accumulated pulse		0.01 gal(US)/pulse	0.05 gal(US)/pulse	0.1 gal(US)/pulse	

## Function selection mode

### Function selection mode

In measurement mode, press the **SET** button, to display [F\_□].

This [F\_□] indicates the mode for changing each functional setting.

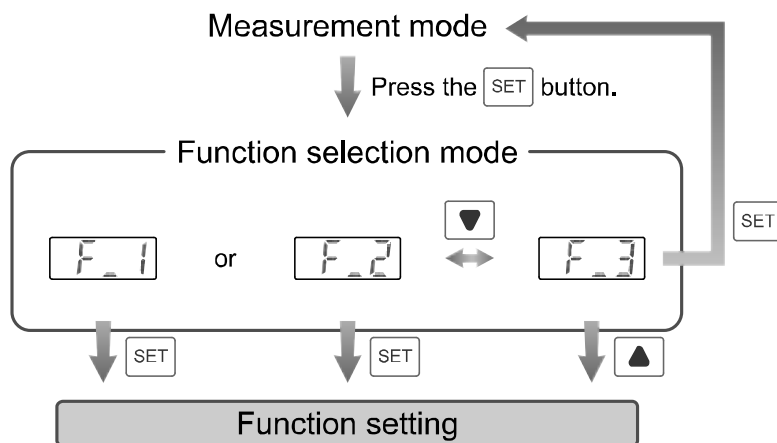

\*: When the output mode is set to instantaneous output mode, [F\_1] is displayed. When the output mode is set to accumulated output mode, [F\_2] is displayed. When the output mode is set to accumulated pulse output mode, [F\_3] is displayed.

### ■Default settings

Item		Default Setting	Page
[F_1] Input the Set value of instantaneous output	[n_1] * Input of the Set point 1	50% of max. rated flow PF2A20□ : [ 5.0] L/min (PF2A510)	Page 27
	[n_2] * Input of the Set point 2	PF2W20□ : [2.00] L/min (PF2W504, PF3W504) PF2D20□ : [2.00] L/min (PF2D504)	
[F_2] Input the Set value of accumulated output	[1nL] * Input of the Set value for the lower 3 digits	[ 0]	Page 28
	[1nH] * Input of the Set value for the upper 3 digits	[ 0]	
[F_3] Copy function	-	-	Page 30

\*: When Non-Reverse output is selected as the switching operation, n becomes P.

## ■[F\_1] Input procedure of the Set value of instantaneous output



The Set point of the switch output can be set manually.

<Operation>

Press the  button in function selection mode to display [F\_1]. (When output mode is assigned to be instantaneous output mode, [F\_1] is displayed. When the output mode is set to accumulated output mode, [F\_2] is displayed. When output mode is assigned to be accumulated pulse output mode, [F\_3] is displayed.)

↓ Press the  button.

### Input of the Set point 1

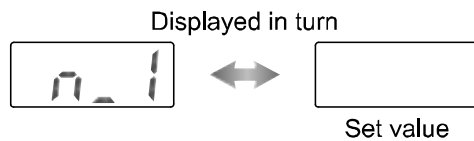

[n\_1]\* and the current Set value are displayed in turn.  
Press the  and  button to change the value referring to the list of outputs (page 20).



\*: When Non-Reverse output is selected as the switch operation, [P\_1] is displayed.

↓ Press the  button.

### Input of the Set point 2

[n\_2]\* and the current Set value are displayed in turn.  
Press the  and  button to change the value referring to the list of outputs (page 20).

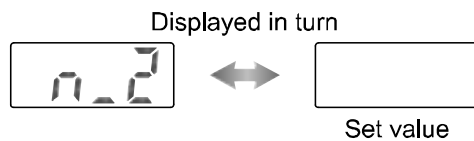

\*: When Non-Reverse output is selected as the switch operation, [P\_2] is displayed.

↓ Press the  button.

[F\_1] Input procedure of the Set value of instantaneous output is completed.  
Return to measurement mode.

## ■[F\_2] Input procedure of the Set value of accumulated output

Press the  button in measurement mode to select the channel to be set.

The Set point of the switch output can be manually set. Accumulated flow rate is displayed by the lower 3 digits and upper 3 digits separately. Setting is performed separately.

<Operation>

Press the  button in function selection mode to display [F\_2]. (When output mode is assigned to be instantaneous output mode, [F\_1] is displayed. When the output mode is set to accumulated output mode, [F\_2] is displayed. When output mode is assigned to be accumulated pulse output mode, [F\_3] is displayed.)

↓ Press the  button.

### Input of the Set value for the lower 3 digits

[1nL]\* and the current Set value are displayed in turn.

Press the  and  button to change the value referring the list of outputs (page 20).

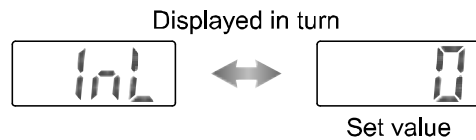



\*: When Non-Reverse output is selected as the switch operation, [1PL] is displayed.

↓ Press the  button.

### Input of the Set value for the upper 3 digits

[1nH]\* and the current Set value are displayed in turn.

Press the  and  button to change the value referring the list of outputs (page 20).

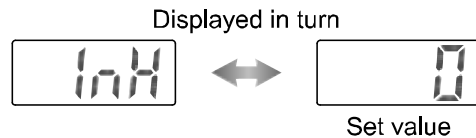

\*: When Non-Reverse output is selected as the switch operation, [1PH] is displayed.

↓ Press the  button.

[F\_2] Input procedure of the Set value of accumulated output is completed.  
Return to measurement mode.

↓ (continued)



### Starting of accumulation

Check that the display of accumulated flow rate is selected as the display mode.

Press the  and  buttons simultaneously in measurement mode.



[-] flashes and accumulation starts.

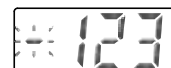

Stop and restart of accumulation are performed the same way.



Pressing the  button displays the instantaneous flow rate while displaying the accumulated flow.

The accumulated flow rate can be displayed up to 999,999 L, but the display normally shows the lower 3 digits.

To display upper three digits, press the  button while the  button is pressed

The display flashes when the value reaches 999,999 L. To reset the accumulated flow value, press the  button while the  button is pressed for 4 seconds or longer.



The accumulated value will be reset if the power supply is turned off.

## ■ [F\_3] Copy function

The following set items can be copied to another channel

- Connected sensor
- Unit selection function (Operate only the product with unit selection function.)
- Reference condition (Operate only the PF2A2□□ series.)
- Set value
- Display mode
- Output mode
- Switch operation

<Operation>

Press the  button in function selection mode to display [F\_3].

(Instantaneous output mode: [F\_1], Accumulated output mode: [F\_2], Accumulated pulse output mode: [F\_3]).

\*: Press the  button to return to measurement mode.

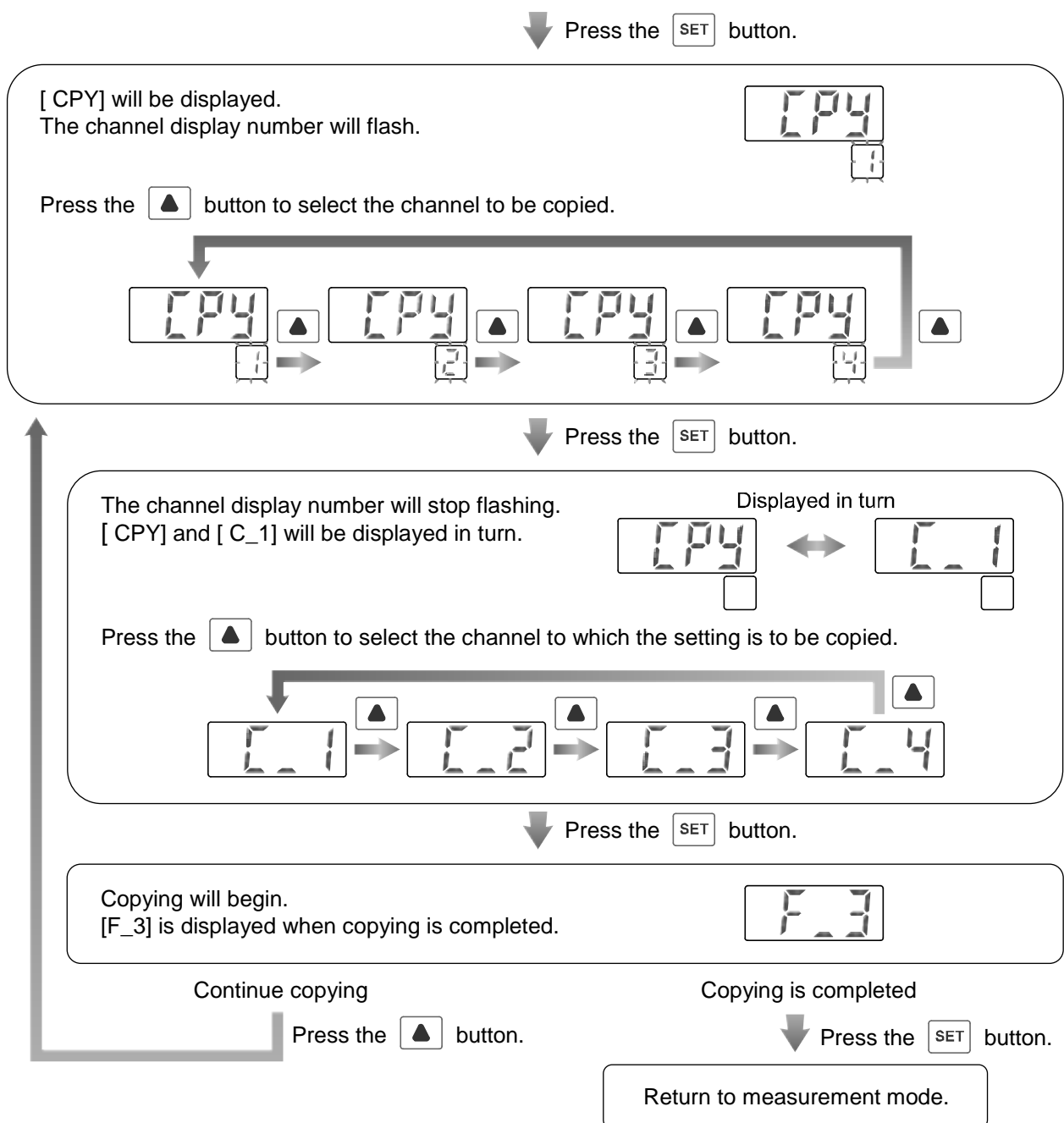

## Other functions

### ■ Channel scan function

The instantaneous flow and accumulate flow value will be displayed in turn for 2 seconds each repeatedly.

<Operation>

Press the  button for 2 seconds or longer in measurement mode.

Example)

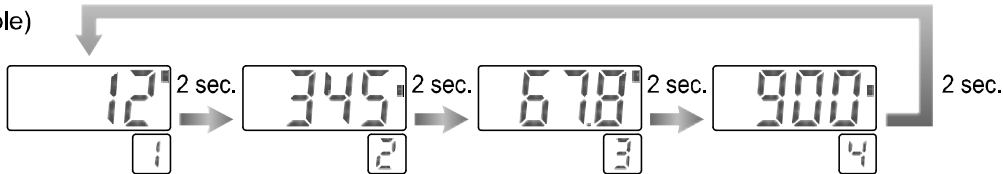





Press the  button again for 2 seconds or longer to release the function.

### ■ Peak/Bottom value display

This function can be only used when the display mode is set to instantaneous flow rate display.

The maximum (minimum) instantaneous flow from when the function was started to this moment is displayed and updated.

<Operation>

1. Check that the display mode is set to instantaneous flow rate.
2. Press the  button in measurement mode to select the channel to be set.
3. Press the  and  buttons simultaneously for 2 seconds or longer in measurement mode.
4. Press the  button to select peak or bottom value.

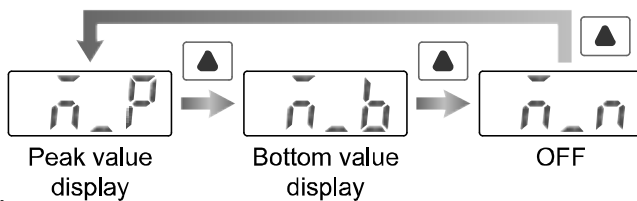

5. Press the  button to return to measurement mode.

- [  ] will appear in the display to indicate peak value display.



- [  ] will appear in the display to indicate bottom value display.



To release, follow the above procedure again from the first step and select [ n\_n ]



\*: Disconnecting the power supply will reset the peak (bottom) value display.





## ■Key-lock function

This function is used to prevent errors occurring due to unintentional changes of the Set values.

### <How to lock>

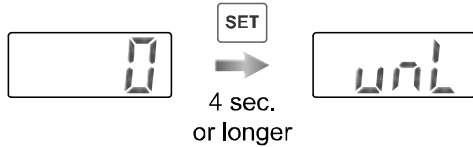
1. Press the  button for 4 seconds or longer in measurement mode. The display will change from [F\_0] to [00L]([00d]) to [unL]. When [unL] is displayed, release the  button.



2. Press the  button to select [Loc], to lock the keys.



3. Key operation is locked by pressing the  button, and returns to measurement mode.



\*: The channels can be selected and the channel scan will function by pressing the  button, even when the keys are locked.

### <How to unlock>

1. Press the  button for 4 seconds or longer in measurement mode.

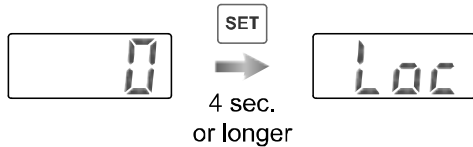

2. Press the  button to select [unL], to unlock the keys.



3. Key operation is unlocked by pressing the  button, and returns to measurement mode.



## Maintenance

### **How to reset the product after a power cut or forcible de-energizing**

The setting of the product will be retained as it was before a power cut or de-energizing.

The output condition is also basically recovered to that before a power cut or de-energizing, but may change depending on the operating environment.

Therefore, check the safety of the whole installation before operating the product.

# Troubleshooting

## Troubleshooting

If an operation failure of the product occurs, please confirm the cause of the failure from the following table. If the cause of the failure cannot be identified and normal operation can be recovered by replacement with a new product, this indicates that the product itself is faulty. Product damage can be caused by the operating environment (system construction, etc.), therefore contact SMC.

### ■ Cross-reference for troubleshooting

Fault		Probable cause	Countermeasures
Display	Display is OFF.	Incorrect wiring	Correct the wiring.
		Connector loose.	Check the connector.
	Display does not change.	Peak (bottom) value display has been selected.	Turn off the peak (bottom) value display (page 31).
	The display is unstable.	Foreign matter inside.	Refer to the operation manual of the sensor.
		The piping is connected in the wrong direction.	Connect the product so that the fluid direction is the same as the arrow indicated on the sensor.
		Flow passage inside the sensor is not filled with fluid. *1	Arrange piping so that the flow passage inside the sensor is filled with fluid.
		Pulsation in the flow.	It is possible that pulsation is generated due to the fluctuation of the supply pressure or the characteristics of the compressor or pump used as the pressure source. Change to a pressure source with less fluctuation or install a tank which reduces the pressure fluctuation.
			Fluid leakage
	The display is not correct.	Foreign matter inside.	Refer to the operation manual of the sensor.
		Piping is connected in the wrong direction.	Connect the product so that the fluid direction is the same as the arrow indicated on the sensor.
		Flow passage inside the sensor is not filled with fluid. *1	Arrange piping so that the flow passage inside the sensor is filled with fluid.
		Incorrect unit selection. *2	Select the correct unit using the unit selection function.
		Fluid leakage	Refer to the operation manual of the sensor.



\*1: Operate only the PF2W2□□ and PF2D2□□ series.

\*2: Operate only the product with unit selection function.

Fault		Type	Troubleshooting
Output	There is no output.	Incorrect wiring	Correct the wiring.
		Connector loose.	Check the connector.
	Output is unstable.	Foreign matter inside.	Refer to the operation manual of the sensor.
		The piping is connected in the wrong direction.	Connect the product so that the fluid direction is the same as the arrow indicated on the sensor.
		Flow passage inside the sensor is not filled with fluid. *1	Arrange piping so that the flow passage inside the sensor is filled with fluid.
		Pulsation in the flow.	It is possible that pulsation is generated due to the fluctuation of the supply pressure or the characteristics of the compressor or pump used as the pressure source. Change to a pressure source with less fluctuation or install a tank which reduces the pressure fluctuation.
		Fluid leakage	Refer to the operation manual of the sensor.
Hysteresis is narrow.	Increase the hysteresis.		
Button	The buttons cannot be operated.	Key-lock function is activated.	Cancel the key-lock function (page 32).
		Channel scan function is valid.	Disable channel scan function (page 29).

\*1: Operate only the PF2W2□□ and PF2D2□□ series.

## ■ Error indication

Error Name	Error Display	Error Type	Troubleshooting Method
Excessive instantaneous flow	---	Flow has exceeded the upper limit of the display flow range.	Reduce the flow.
Over current error	Er 1	The switch output load current is more than 80 mA (OUT1).	Turn the power off and remove the cause of the over current. Then turn the power on again.
System error	Er 0	Internal data error.	Contact SMC to repair.
	Er 5		
	Er 6		
	Er 7		
	Er 10		
Excessive accumulated flow	 Accumulated flow displayed (flashing)	The display flow range of accumulated flow has been exceeded.	To reset the accumulated flow value, press the  button while the  button is pressed for 4 seconds or longer (page 31).

\*: If the error cannot be reset after the above measures are taken, then please contact SMC.

# Specification

## ■ Specifications

### ● PF2A20□

Model		PF2A20□					
Applicable sensor		PF2A510	PF2A550	PF2A511	PF2A521	PF2A551	
Flow	Rated flow range	1 to 10 L/min	5 to 50 L/min	10 to 100 L/min	20 to 200 L/min	50 to 500 L/min	
	Instantaneous flow	Setting/display flow range *1 *2	0.5 to 10.5 L/min	2.5 to 52.5 L/min	5 to 105 L/min	10 to 210 L/min	25 to 255 L/min
		Min. setting/display unit	0.1 L/min	0.5 L/min	1 L/min	2 L/min	5 L/min
	Accumulated Flow	Setting/display flow range	0 to 999999 L				
		Min. setting/display unit	1 L				
	Reference condition *3		Standard condition, Normal condition *4				
Switch output	Output mode *3		NPN open collector output, PNP open collector output Instantaneous flow output mode (hysteresis mode, window comparator mode) Accumulated flow output mode, Accumulated pulse output mode				
	Switch operation *3		Non-Reversed output, Reversed output				
	Max. load current		80 mA				
	Max. applied voltage		30 VDC (NPN output)				
	Internal voltage drop		1 V or less (at 80 mA)				
	Response time		1 s or less				
	Repeatability *5		±1%F.S. max.				
	Accuracy *5		±5%F.S. max.				
	Hysteresis		Hysteresis mode: Variable *3 Window comparator mode: Fixed (3 digits)				
	Output protection		Short circuit protection				
	Accumulated pulse	Pulse width	50 ms				
Conversion of accumulated pulse		0.1 L/pulse	0.5 L/pulse	1 L/pulse	2 L/pulse	5 L/pulse	

\*1: Display flow range in the specification is the value at standard condition.

If the display unit standard is changed from standard to normal, use the conversion formula.

Flow rate at standard condition x 0.927 = Flow rate at normal condition

\*2: If the flow rate is smaller than the minimum flow of the display range, "0 L/min" is displayed.

\*3: Selectable by setting.

\*4: Standard condition: Flow display which is converted in atmospheric pressure at 20 °C, 65%R.H.

Normal condition: Flow display which is converted in atmospheric pressure at 0 °C.

\*5: Total accuracy when used with applicable sensor.

●PF2W20□

Model		PF2W20□				
Applicable sensor		PF2W504(T)	PF2W520(T)	PF2W540(T)	PF2W511(T)	
		PF3W504	PF3W520	PF3W540	PF3W511	
Flow	Rated flow range		0.5 to 4.0 L/min	2 to 16 L/min	5 to 40 L/min	10 to 100 L/min
	Instantaneous flow	Setting/display flow range *1	0.35 to 4.50 L/min	1.7 to 17.0 L/min	3.5 to 45.0 L/min	7 to 110 L/min
		Min. setting/display unit	0.05 L/min	0.1 L/min	0.5 L/min	1 L/min
	Accumulated Flow	Setting/display flow range	0 to 999999 L			
		Min. setting/display unit	1 L			
Switch output			NPN open collector output, PNP open collector output			
	Output mode *2		Instantaneous flow output mode (hysteresis mode, window comparator mode) Accumulated flow output mode, Accumulated pulse output mode			
	Switch operation *2		Non-Reversed output, Reversed output			
	Max. load current		80 mA			
	Max. applied voltage		30 VDC (NPN output)			
	Internal voltage drop		1 V or less (at 80 mA)			
	Response time		1 s or less			
	Repeatability *3		±1%F.S. max.			
	Accuracy *3		±5%F.S. max.			
	Hysteresis		Hysteresis mode: Variable *2 Window comparator mode: Fixed (3 digits)			
	Output protection		Short circuit protection			
Accumulated pulse	Pulse width		50 ms			
	Conversion of accumulated pulse		0.05 L/pulse	0.1 L/pulse	0.5 L/pulse	1 L/pulse

\*1: If the flow rate is smaller than the minimum flow of the display range, "0 L/min" is displayed.

\*2: Selectable by setting.

\*3: Total accuracy when used with applicable sensor.

●PF2D20□

Model		PF2D20□			
Applicable sensor		PF2D504	PF2D520	PF2D540	
Flow	Rated flow range	0.4 to 4.0 L/min	1.8 to 20.0 L/min	4 to 20 L/min	
	Instantaneous flow	Setting/display flow range *1	0.25 to 4.50 L/min	1.3 to 21.0 L/min	2.5 to 45.0 L/min
		Min. setting/display unit	0.05 L/min	0.1 L/min	0.5 L/min
	Accumulated Flow	Setting/display flow range	0 to 999999 L		
		Min. setting/display unit	1 L		
Switch output	NPN open collector output, PNP open collector output				
	Output mode *2	Instantaneous flow output mode (hysteresis mode, window comparator mode) Accumulated flow output mode, Accumulated pulse output mode			
	Switch operation *2	Non-Reversed output, Reversed output			
	Max. load current	80 mA			
	Max. applied voltage	30 VDC (NPN output)			
	Internal voltage drop	1 V or less (at 80 mA)			
	Response time	1 s or less			
	Repeatability *3	±1%F.S. max.			
	Accuracy *3	±5%F.S. max.			
	Hysteresis	Hysteresis mode: Variable *2 Window comparator mode: Fixed (3 digits)			
	Output protection	Short circuit protection			
Accumulated pulse	Pulse width	50 ms			
	Conversion of accumulated pulse	0.05 L/pulse	0.1 L/pulse	0.5 L/pulse	

\*1: If the flow rate is smaller than the minimum flow of the display range, "0 L/min" is displayed.

\*2: Selectable by setting.

\*3: Total accuracy when used with applicable sensor.



•Common Specifications

Model		PF2□20□
Display	Display part	Displayed digit: 4 digits 7 segments, Colour: Orange
	Channel display	Displayed digit: 1 digit 7 segments, Colour: Red
	Indicator light (output)	When ON, Red light is ON
Supply voltage		24 VDC±10%
Power consumption (no load)		55 mA or less
Environment	Enclosure	Front part: IP65 (at panel mounting), Other: IP40
	Operating temperature range	Operation: 0 to 50 °C, Storage: -10 to 60 °C (No freezing or condensation)
	Operating humidity range	Operation, Storage: 35 to 85%R.H. (No condensation)
	Temperature characteristics	±2%F.S. max. (0 to 50 °C, 25 °C reference)
	Withstand voltage	1000 VAC, for 1minute between the external terminals and case
	Insulation resistance	50 MΩ or more (with 500 VDC mega meter) between the external terminals and case
Standards and regulations		CE marked (EMC directive, RoHS directive)
Materials		Body: PBT, Display: PET, Rubber cover for the back: CR
Weight	Weight of the body	60 g
	Cable weight	65 g

•Lead wire Specifications

Sheath	Finished outside diameter	approx. 4.8 mm
	Material	Heat resistant polyethylene
Insulator	Colour	Brown, Black, Grey, Red, Green, Blue, White, Yellow
	Outside diameter	approx. 0.9 mm
Conductor	Nominal cross section area	approx. 0.15 mm <sup>2</sup>
	Outside diameter	approx. 0.5 mm

## ■ Dimensions (in mm)

PF2□20□

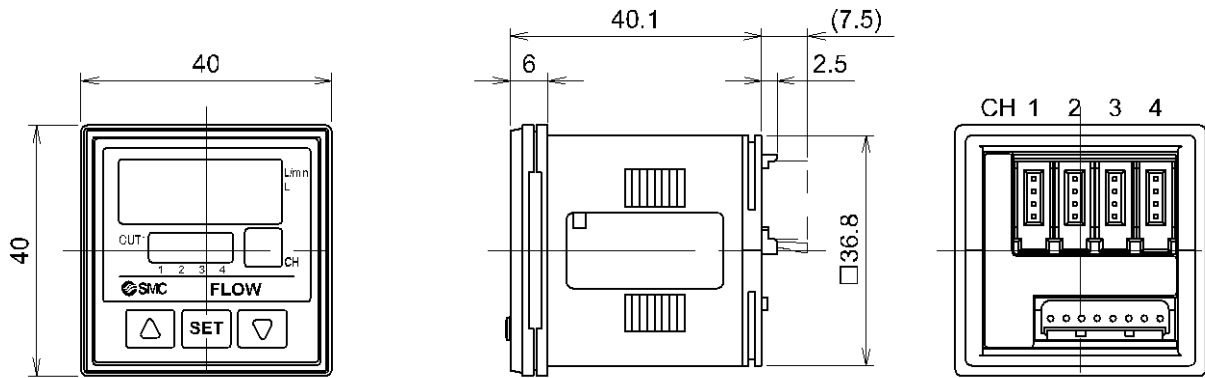

PF2□20□ + panel mount adapter (ZS-26-B) + front protective cover (ZS-26-01)

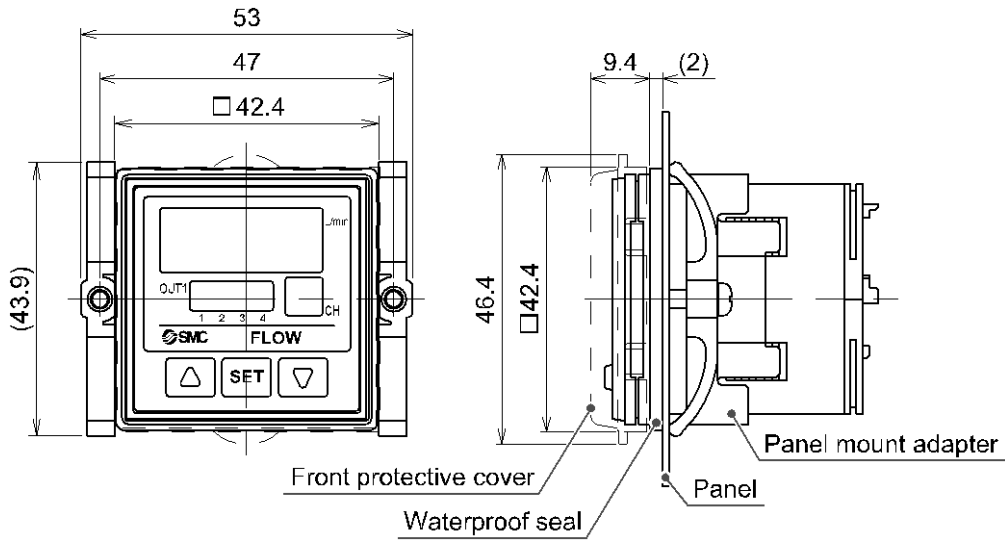

PF2□20□ + panel mount adapter (ZS-26-B) + front protective cover (ZS-26-01) + □48 mm conversion adapter (ZS-26-D)

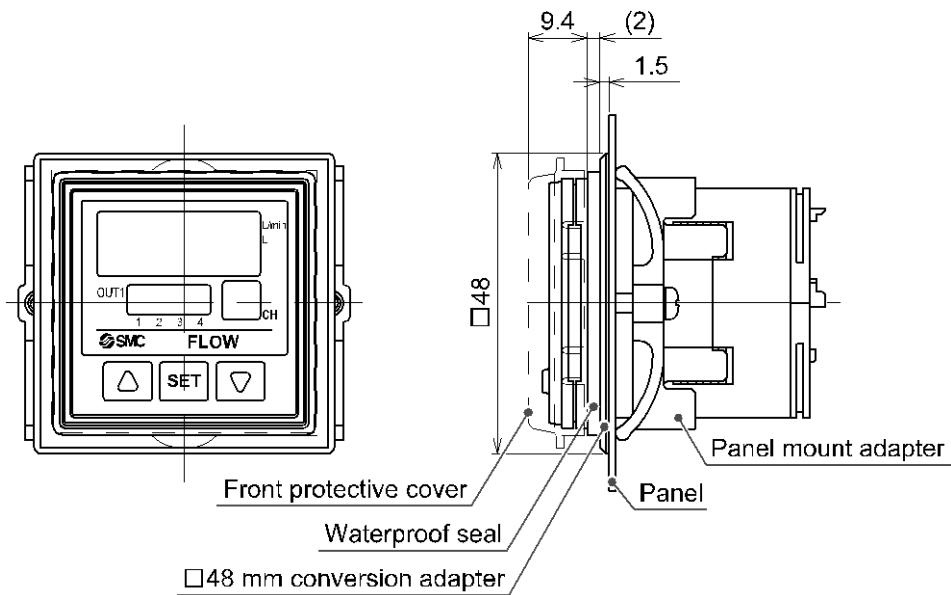

### Panel cut-out dimensions

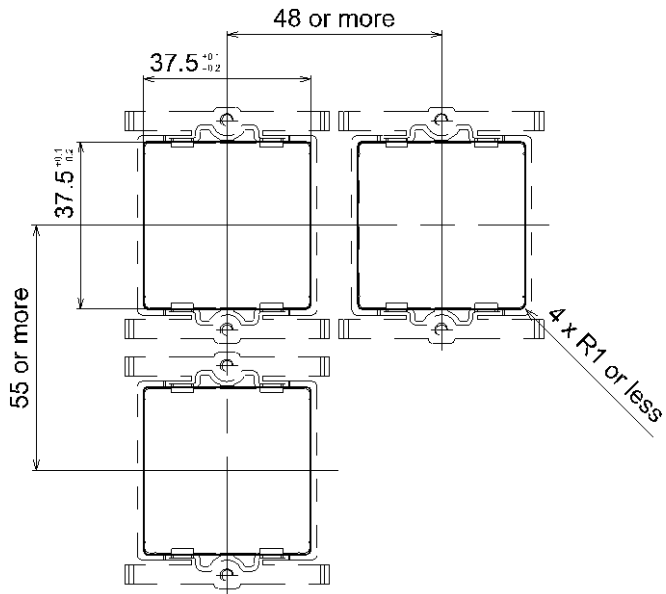

\*: Suitable for panel thickness of 0.5 to 8 mm. (When the waterproof seal is used, Suitable for panel thickness of 0.5 to 6 mm.)

### Power and output cable (ZS-26-A)

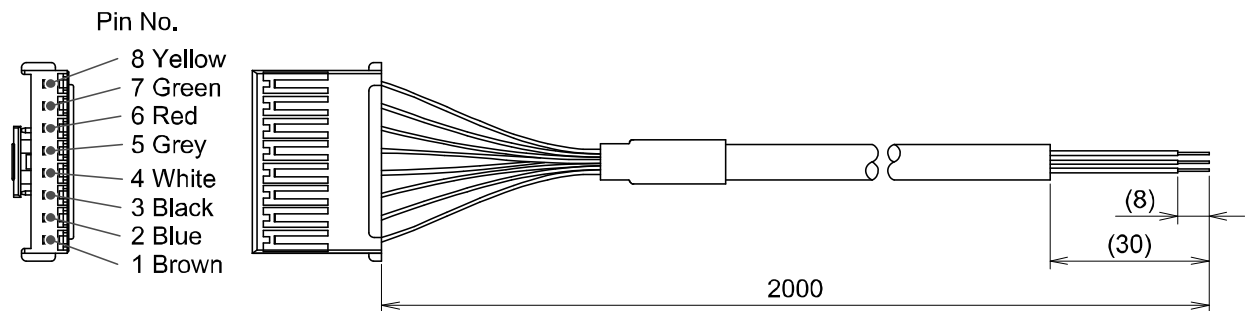

### Sensor connector

•ZS-28-C

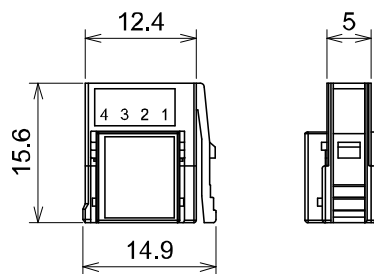

•ZS-28-CA-□

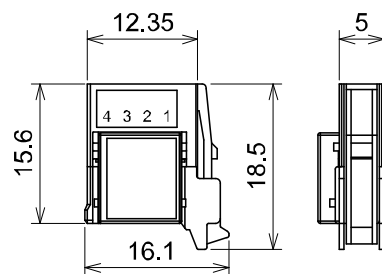

#### Revision history

- A: Full scale revision due to the change of the format and addition of items.
- B: Content is changed due to the change of the format.
- C: Contents revised in several places.
- D: Contents are added.
- E: Contents revised in several places. [July 2018]
- F: Contents revised in several places.  
[August 2019]

## SMC Corporation

4-14-1, Sotokanda, Chiyoda-ku, Tokyo 101-0021 JAPAN

Tel: + 81 3 5207 8249 Fax: +81 3 5298 5362

URL <https://www.smcworld.com>

---

Note: Specifications are subject to change without prior notice and any obligation on the part of the manufacturer.  
© 2011-2019 SMC Corporation All Rights Reserved

