



ORIGINAL INSTRUCTIONS

Installation & Maintenance Manual

Solenoid valve for manifold pilot control:

VQC2101NY-5-X10

(Basic and well-ried safety principles in accordance to ISO 13849)

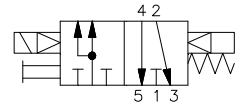

The intended use of the valve is to control the external pilot air of other valves on the same valve manifold.

This product is validated according to ISO 13849 basic and well-ried safety principles. Refer to Doc. Nr. VQC2000V-SMP0002.

1 Safety Instructions

This manual contains essential information for the protection of users and others from possible injury and/or equipment damage.

- Read this manual before using the product, to ensure correct handling, and read the manuals of related apparatus before use.
- Keep this manual in a safe place for future reference.
- These instructions indicate the level of potential hazard by label of "DANGER", "WARNING" or "CAUTION", followed by important safety information which must be carefully followed.
- To ensure safety of personnel and equipment the instructions in this manual and the product catalogue must be observed, along with other relevant safety practices.

Take care about the compliance with the relevant safety laws and standards.

CAUTION	Indicates a hazard with a low level of risk, which if not avoided, could result in minor or moderate injury.
WARNING	Indicates a hazard with a medium level of risk, which if not avoided, could result in death or serious injury.
DANGER	Indicates a hazard with a high level of risk, which if not avoided, will result in death or injury.

WARNING

- The compatibility of pneumatic equipment is the responsibility of the person who designs the pneumatic system or decides its specifications. Since the products specified here can be used in various operating conditions, their compatibility with the specific pneumatic system must be based on specifications or after analysis and/or tests to meet specific requirements.
- Only trained personnel should operate pneumatically operated machinery and equipment.**
Compressed air can be dangerous if an operator is unfamiliar with it. Assembly, handling or repair of pneumatic systems should be performed by trained and experienced personnel.
- Do not service machinery/equipment or attempt to remove components until safety is confirmed.**
1) Inspection and maintenance of machinery/equipment should only be performed after confirmation of safe locked-out control positions.
2) When equipment is to be removed, confirm the safety process as mentioned above. Switch off air and electrical supplies and exhaust all residual compressed air in the system.
3) Before machinery/equipment is re-started, ensure all safety measures to prevent sudden movement of cylinders etc. (Supply air into the system gradually to create back pressure, i.e. incorporate a soft-start valve).
- Do not use this product outside of the specifications. Contact SMC if it is to be used in any of the following conditions:**
1) Conditions and environments beyond the given specifications, or if the product is to be used outdoors.
2) Installations in conjunction with atomic energy, railway, air navigation, vehicles, medical equipment, food and beverage, recreation equipment,

- emergency stop circuits, press applications, or safety equipment.
- 3) An application which has the possibility of having negative effects on people, property, or animals, requiring special safety analysis.
- Effect of back pressure when using a manifold**
This valve is designed to be used on a manifold. This valve may experience back pressure due to pressure in the manifold exhaust ports. Back pressure check valves can be used to prevent back pressure affecting the outlet ports of this valve.
- Ventilation**
Provide ventilation when using a valve in a confined area, such as in a closed control panel. For example, install a ventilation opening, etc. in order to prevent pressure from increasing inside of the confined area and to release the heat generated by the valve.
- Operation in a low temperature condition**
It is possible to operate a valve in extreme temperature, as low as -10°C. Take appropriate measures to avoid freezing of drainage, moisture etc. in low temperature.
- Do not disassemble the product or make any modifications**

CAUTION

- Ensure that the air supply system is filtered to 5 µm.**

2 Specifications

2.1 General specifications

Valve specifications	Special 5-Port Solenoid Valve ^{Note 1)}	
	Valve Type	Rubber seal (Pilot valve V100)
	Valve Configuration	Air / spring return
	De-energized actuation	Air
	Fluid	0.7 MPa
	Max. operating pressure	0.25 MPa
	Min. operating pressure	1.05 MPa
	Proof pressure	31 ms or less ^{Note 2)}
	Response time	1 cycle / 30 days
	Minimum frequency	105 g
	Mass	-10 to +50°C (No freezing)
	Ambient temperature	Not required
	Lubrication	Push type
	Manual override	150 / 30 m/s ^{Note 3)}
	Impact resistance/ Vibration resistance	universal
	Mounting orientation	IP67
	Enclosure	Refer to VQC2000V-SMP0002
	Service life B ₁₀	24 VDC
Elect.	Rated coil voltage	±10 % of rated voltage ^{Note 4)}
	Allowable voltage fluctuation	Class B or equivalent
	Coil insulation type	0.4 W DC (17 mA)
	Power consumption (Current)	

Table 1

2.2 Flow-rate

Model	Flow-rate Characteristics					
	1 -> 4,2 (P > A,B)			4,2 -> 5,3 (A,B > R1,R2)		
	C[dm ³ /(s·bar)]	b	Cv	C[dm ³ /(s·bar)]	b	Cv
VQC2101NY-5-X10	2.2	0.28	0.55	3.2	0.30	0.80

Table 2

- Note 1)
When the Air Supply is cut (port 1 (P)) the main valve returns to the original position.
- Note 2)
Values represented in this column are based on JIS 8375-1981 (operating with clean air and a supply pressure of 0,5 MPa equipped with light/surge voltage suppressor. Values vary depending on the pressure as well as the air quality.) Tested with ports size C8 and without back pressure check valves

Note 3)
Impact resistance: No malfunction occurred when it was tested with a drop tester in the axial direction and at right angles to the main valve & armature; in both energized & de-energized states and for every time in each condition (Values at the initial period.)
Vibration resistance: No malfunction occurred in a one-sweep test between 45 and 2000 Hz. Tests are performed at both energized and de-energized states in the axial direction and at right angles to the main valve & armature.
Note 4) If power supply is under -10% of standard power supply 24 V DC the valve may switch to the OFF position. The valve may switch to the de-energized state.

2.3 Symbol

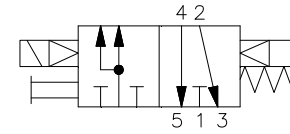

Figure 3

2.4 Light/Surge Voltage Suppressor

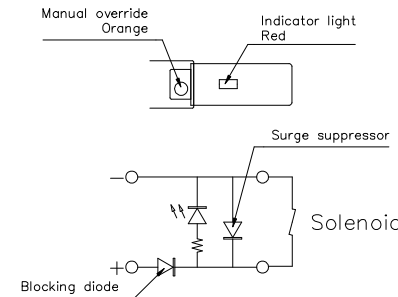

Figure 4

Valve is only available as negative COM Type (PNP).

3 Installation

WARNING

- ### 3.1 Environment
- Do not use in an environment where the product is directly exposed to corrosive gases, chemicals, salt water, water or steam.
 - Products with IP67 enclosures (based on IEC60529) are protected against dust and water, however, these products cannot be used in water.
 - Incorrect mounting of the product violates the IP67 rating. Be sure to read the precautions of mounting for each product.
 - Do not use in an explosive atmosphere.
 - The product should not be exposed to prolonged sunlight. Use a protective cover.
 - Do not mount the product in a location where it is subject to strong vibrations and/or shock. Check the product specifications.
 - Do not mount the product in a location exposed to radiant heat.

3.2 Piping

- Preparation before piping
Before piping is connected, it should be thoroughly blown out with air (flushing) or washed to remove chips, cutting oil and other debris from inside the pipe.
Install piping so that it does not apply pulling, pressing, bending or other forces the valve body.
- Holding of pressure
Rubber sealed spool valves may have a slight leakage. This has to be taken into account for applications, in which the loss of pressure leads to a hazardous movement.
- Maintenance space.
The installation should have sufficient space for maintenance activities (removal of valve, etc.).
- Release of residual pressure.
Provide a residual pressure release function for maintenance activities (removal of valve, etc.)

CAUTION

- ### 3.3 Lubrication
- SMC products have been lubricated for life at manufacture, and do not require lubrication in service.
 - If a lubricant is used in the system, use turbine oil Class 1 (no additive), ISO VG32. Once lubricant is used in the system, lubrication must be continued because the original lubricant applied during manufacturing will be washed away.

WARNING

- ### 3.4 Mounting
- Stop operation if air leakage increases and the equipment do not operate properly.**
Check mounting conditions after air and power supplies are connected. Initial function and leakage tests should be performed after installation.
 - Instruction manual (this document)**
Install only after reading and understanding the safety instructions. Keep on file so that it can be referred to when necessary.

- ### 3. Coating
- Warnings or specifications indicated on the product should not be erased, removed, or covered up.

CAUTION

- ### 3.5 Wiring
- Applied voltage.**
When electric power is connected to the solenoid valve, be careful to apply the proper voltage. Improper voltage may cause malfunction or coil damage.
 - Confirm the connections.**
After completing the wiring, confirm that the connections are made correctly.

4 Settings

4.1 Manual override WARNING

Since connected equipment will operate when the manual override is activated, confirm that conditions are safe prior to activation. The non-locking push type (tool required) is standard.

Non-locking push type (Tool required)

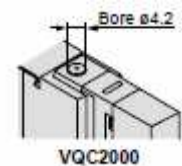

Figure 5

The manual override will actuating the pilot valve and the pilot valve pressure will actuating the main valve movement.

4.2 Solenoid Valve Removal and Mounting (VQC2000)

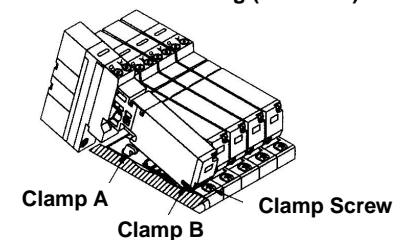

Figure 6

4.2.1 Removal steps

1. Loosen the clamp screws until they turn freely. (The screws do not come out.)
2. Remove the solenoid valve from clamp B by lifting the coil side of the valve while pushing on the screw top. If pushing down on the screw is difficult, you can alternately press down on the valve gently in the area near the manual override.

4.2.2 Mounting steps

1. Push the clamp screws. Clamp A opens. Now insert the end plate hook of the valve into clamp B at an angle.
2. Push the valve down into place. (When you release the screws, the valve will be locked into clamp A.)
3. Tighten the clamp screws with a tightening torque of 0.5 to 0.7 N·m

CAUTION

Dust on the sealing surface of the gasket or solenoid valve can cause air leakage.

Take care that the pilot pressure is able to exhaust. Do not block the Exhaust Ports.

1. Shut off the fluid supply and release the fluid pressure in the system.
2. In the case of air pilot or air-operated type, shut off the supply air source and discharge the compressed air inside the pilot piping.
3. Shut off the power supply.
4. Remove the product.

3. Low frequency operation.

Valves should be operated at least once every 30 days to prevent malfunction. (Use caution regarding the air supply). For optimum usage, conduct regular inspections every 6 months.

4. Manual override

When the manual override is operated, connected equipment will be actuated.

5. Do not disassemble the product.

1. Filters and strainers

1. Be careful regarding clogging of filters and strainers.
2. Replace filter elements after one year of use, or earlier if the pressure drop reaches 0.1 MPa.
3. Clean strainers when the pressure drop reaches 0.1 MPa.

2. Drain flushing

Remove drainage from air filters regularly. (Refer to the specifications.)

5.1 Replacing One-touch fittings

CAUTION

Cylinder port fittings are available with cassette type manifolds and are easily replaced. Fittings are secured with a retaining clip that is inserted vertically from either the top or bottom of the manifold. After removing the valve, remove the clip with a flat head screwdriver to replace the fittings. To mount a fitting, insert the fitting assembly until it spots and reinsert the retaining clip to its designated position.

Warning

If a safe output from a safety relay or PLC is used to operate this valve, ensure that any output test pulse duration is shorter than 1 ms to avoid the valve solenoid responding.

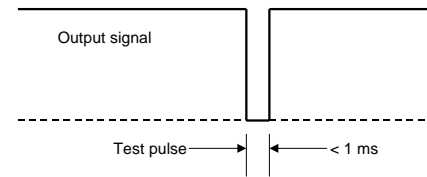

5 How to order

Order Number **VQC2101NY-5-X10**

6 Outline dimensions (mm)

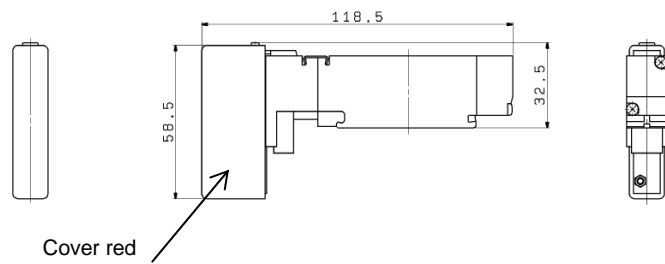
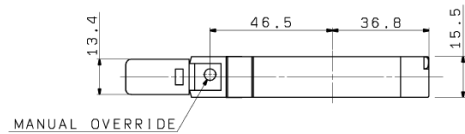

Special Pilot valve Cover (Color: Red)

(Dimensions are in Millimeter)

7 Maintenance

WARNING

1. Perform maintenance procedures shown in this instruction manual. If handled improperly malfunction or damage of machinery/equipment may occur.

2. Removing the product

To avoid the risk of being burned, ensure that the valve has had sufficient time to cool before performing work.

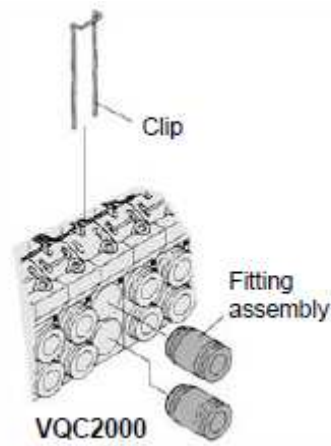

Figure 7

8 Limitations of Use

DANGER

This Special Valve is developed for use only on a Special Manifold block Assembly:

VVQC2000-1A-#-C0-X10

= S – single wiring

= D – double wiring

Use on other manifold block assemblies is not allowed. This can cause damage or malfunction.

Any use in an EN ISO 13849 system must be within the specified limits and application condition. The user is responsible for the specification, design, implementation, validation and maintenance of the safety system (SRP/CS).

6 Contacts

AUSTRIA	(43) 2262 62280-0	LATVIA	(371) 781 77 00
BELGIUM	(32) 3 355 1464	LITHUANIA	(370) 5 264 8126
BULGARIA	(359) 2 974 4492	NETHERLANDS	(31) 20 531 8888
CZECH REP.	(420) 541 424 611	NORWAY	(47) 67 12 90 20
DENMARK	(45) 7025 2900	POLAND	(48) 22 211 9600
ESTONIA	(372) 651 0370	PORTUGAL	(351) 21 471 1880
FINLAND	(358) 207 513513	ROMANIA	(40) 21 320 5111
FRANCE	(33) 1 6476 1000	SLOVAKIA	(421) 2 444 56725
GERMANY	(49) 6103 4020	SLOVENIA	(386) 73 885 412
GREECE	(30) 210 271 7265	SPAIN	(34) 945 184 100
HUNGARY	(36) 23 511 390	SWEDEN	(46) 8 603 1200
IRELAND	(353) 1 403 9000	SWITZERLAND	(41) 52 396 3131
ITALY	(39) 02 92711	UNITED KINGDOM	(44) 1908 563888

SMC Corporation

SMC Corporation www.smcworld.com (Global) www.smceu.com (Europe)
 SMC Corporation, Akihabara UDX15F, 4-14-1, Sotokanda, Chiyoda-ku, Tokyo 101-0021 JAPAN
 Specifications are subject to change without prior notice from the manufacturer.
 The descriptions of products in this document may be used by other companies.
 © 2012 SMC Corporation All Rights Reserved.