



Operation Manual

Communication function

Thermo chiller

Air-Cooled refrigerated type

HRS012-A-10-**
HRS018-A-10-**
HRS012-A-20-**
HRS018-A-20-**
HRS024-A-20-**
HRS030-A-20-**
HRS040-A-20**
HRS050-A-20-**
HRS060-A-20-**

Water-Cooled refrigerated type

HRS012-W-10-**
HRS018-W-10-**
HRS012-W-20-**
HRS018-W-20-**
HRS024-W-20-**
HRS030-W-20-**
HRS040-W-20-**
HRS050-W-20-**
HRS060-W-20-**

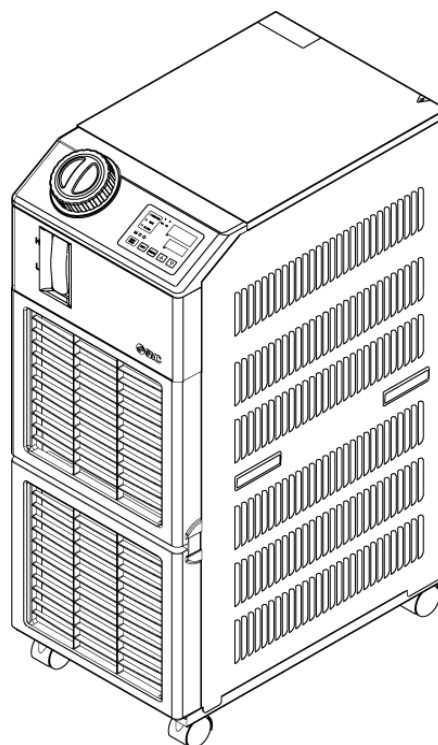
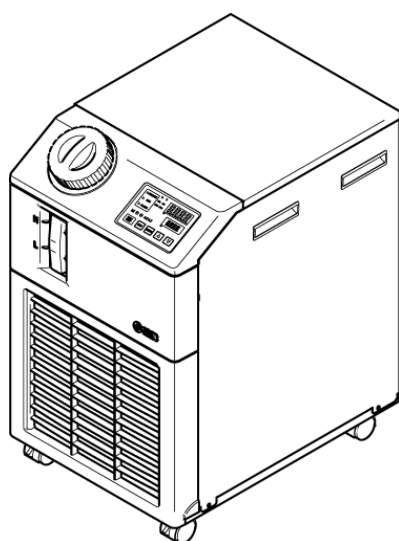

Keep this manual available whenever necessary

To Users,

Thank you for purchasing SMC's Thermo chiller (hereinafter referred to as the "product").

For safety and long life of the product, be sure to read this operation manual (hereinafter referred to as the "manual") and clearly understand the contents.

- Be sure to read and follow all instructions noted with "Warning" or "Caution" in this manual.
- This manual is intended to explain the installation and operation of the product. Only people who understand the basic operation of the product through this manual or who performs installation and operation of or have basic knowledge about industrial machines are allowed to work on the product.
- This manual and other documents attached to the product do not constitute a contract, and will not affect any existing agreements or commitments.
- It is strictly prohibited to copy this manual entirely or partially for the use by the third party without prior permission from SMC.

Note: This manual is subject to possible change without prior notice.

Contents

Chapter 1	Read before using	1-1
1.1	Communication mode and operation method	1-2
1.2	Communication port	1-3
1.3	Key operations	1-4
1.4	Parameters.....	1-6
Chapter 2	Contact input/output communication	2-1
2.1	Precautions for communication	2-1
2.1.1	Precautions wiring communication.....	2-1
2.1.2	Precautions after wiring and before communication	2-2
2.2	Communication specification.....	2-2
2.3	Terminal block explanation.....	2-2
2.4	Setting and checking	2-4
2.4.1	Setting and checking	2-4
2.4.2	Setting and checking	2-5
2.5	Contact input signal	2-16
2.5.1	Run/stop signal·Remote signal.....	2-16
2.5.2	Signal of the external switch.....	2-18
2.6	Contact output signal.....	2-19
Chapter 3	Serial communication	3-1
3.1	Precautions wiring communication	3-1
3.2	Communication specification.....	3-1
3.3	Connected explanation	3-2
Chapter 4	MODBUS communication function	4-1
4.1	Precautions for communication	4-1
4.1.1	Precautions after wiring and before communication	4-1
4.1.2	Precautions for communicating	4-2
4.2	Communication specification.....	4-2
4.3	Setting and checking	4-3
4.3.1	Setting and checking items	4-3
4.3.2	Setting and checking	4-4
4.4	Communication sequence	4-7
4.5	Message configuration	4-8
4.5.1	Message format.....	4-8
4.5.2	Message example	4-9
4.6	Function codes.....	4-10
4.7	LRC.....	4-10
4.8	Explanation of function codes	4-11
4.8.1	Function code : 03 Reading multiple registers	4-11
4.8.2	Function code : 06 Writing registers	4-12

4.8.3	Function code : 16 Writing multiple registers	4-13
4.8.4	Function code : 23 Reading/writing multiple registers	4-14
4.9	Negative response	4-16
4.10	Register Map	4-17
4.10.1	Circulating fluid discharge temperature	4-17
4.10.2	Circulating fluid discharge pressure	4-17
4.10.3	Electric resistivity/conductivity of the circulating fluid	4-17
4.10.4	Status flag	4-18
4.10.5	Alarm flag	4-19
4.10.6	Circulating fluid set temperature	4-20
4.10.7	Operation Start Command	4-20
Chapter 5	Simple communication protocol function	5-1
5.1	Precautions for communication	5-1
5.1.1	Precautions after wiring and before communication	5-1
5.1.2	Precautions for communicating	5-2
5.1.3	Precautions after the completion of the communication	5-2
5.2	Communication specification	5-3
5.3	Setting and checking	5-4
5.3.1	Setting and checking items	5-4
5.3.2	Setting and checking	5-5
5.4	Communication sequence	5-11
5.5	Message configuration	5-12
5.5.1	Message format	5-12
5.5.2	Message example	5-14
5.6	BCC	5-15
5.7	Command	5-15
5.8	Command explanation	5-16
5.8.1	Command:PV1 Circulating fluid discharge temperature	5-16
5.8.2	Command:SV1 Circulating fluid set temperature (R)	5-17
5.8.3	Command:SV1 Circulating fluid set temperature (W)	5-18
5.8.4	Command:LOC Key-lock setting (R)	5-19
5.8.5	Command:LOC Key-lock setting (W)	5-20
5.8.6	Command:STR Saves data (W)	5-21
5.9	Negative response	5-22
Chapter 6	Communication alarm function	6-1
6.1	Communication alarm occurs	6-1
6.2	Communication alarm reset	6-2
6.3	Setting and checking	6-2
6.3.1	Setting and checking items	6-2
6.3.2	Setting and checking	6-3

Chapter 1 Read before using

The communication of this device consists of contact input/output communication and serial communication.

MODBUS communication and simple communication protocol can be selected as the serial communication protocol. Depending on the customer's specification, communication can be changed to contact input/output communication or serial communication.

Table 1-1 Communication method

Contact input/output communication		This product is equipped with a terminal which runs/stops the product by remote control and a terminal which can pick up alarm signals. The terminals can be changed depending on the customer's application.
Serial communication	MODBUS standard protocol	Serial communication (RS-485/RS232C) enables remote control of run/start of the product, temperature setting, and details of product condition and alarm condition can be obtained.
	Simple communication protocol	Serial communication (RS-485/RS232C) enables remote control of temperature setting. This protocol complies with SMC thermo-cooler HRG, HRGC series. (We recommend using the MODBUS protocol if you are unfamiliar with using the communication function.) There are two ways to start and stop by simple communication protocol. The customer can choose between operation using the Operation display panel (simple communication protocol 1) and remote control using the contact input (simple communication protocol 2).

●If using contact input/output communication, refer to chapter 2.

●If using serial communication MODBUS, refer to chapter 3 for serial communication specifications first, then refer to chapter 4 for protocol specifications.

●If using simple communication protocol for serial communication, refer to chapter 3 for serial communication specifications first, then refer to chapter 5 for protocol specifications.

1.1 Communication mode and operation method

LOCAL, DIO and SERIAL are available as the communication modes. Table 1.1-1 explains the communication modes. The default setting is LOCAL.

The operation method depends on the communication mode. Table 1.1-2 shows how the communication mode and method of operation are related.

The operation of the product functions depends on the communication mode. Table 1.1-3 shows how the communication mode and functions of this product are related.

Table 1.1-1 Communication modes

Communication mode	Explanation
LOCAL	Mode allowing the product to be operated by the operation panel.
DIO	Mode allowing the product to be operated by the contact input/output communication. When the communication mode is "DIO", operation mode automatically becomes "DIO REMOTE". "DIO REMOTE" and "DIO LOCAL" can be selected by DIO communication signal. DIO REMOTE : Contact input/output communication takes control of the operation of the product. The [REMOTE] lamp on the operation panel turns on. DIO LOCAL : Operation control of the product is the same as that of LOCAL. The [REMOTE] lamp on the operation panel turns off.
SERIAL	Mode allowing the product to be operated by serial communication. MODBUS/ simple communication protocol can be selected.

Table 1.1-2 Communication mode and operation

	LOCAL	DIO		MODBUS	SERIAL	
		DIO LOCAL	DIO REMOTE		Simple communication protocol pattern	
					1	2
Run/Stop control with operation display panel	○	○	×	×	○	×
Circulating fluid discharge temperature setting control with operation display panel	○	○	○	×	×	
Except above with operation display panel	○	○	○	○	○	
Condition reading with operation display panel	○	○	○	○	○	
Run/Stop operation by contact input/output communication	×	×	○	×	×	○
Condition reading by contact input/output communication	○	○	○	○	○	
Reading of the external switch	○	○*1	○*1	○	○	○*1
Run/Stop operation by serial communication.	×	×	×	○	×	
Circulating fluid discharge temperature setting control by serial communication.	×	×	×	○	○	
Condition reading by serial communication.	○	○	○	○	○	

*1: Only one external switch can be installed.

Table 1.1-3 Communication mode and product functions

	LOCAL	DIO		MODBUS	SERIAL	
		DIO LOCAL	DIO REMOTE		Simple communication protocol pattern	
					1	2
Run timer	○	○	×	×	○	×
Stop timer	○	○	×	×	○	×
Recovery from power failure	○	○	×	×	○	×
Anti-freezing	○	○	○	○	○	○
Pump accumulated operating time reset	○	○	×	×	○	×

1.2 Communication port

The communication port at the back of the product is used for communication. Fig 1.2-1, Fig 1.2-2 shows the location of the communication port.

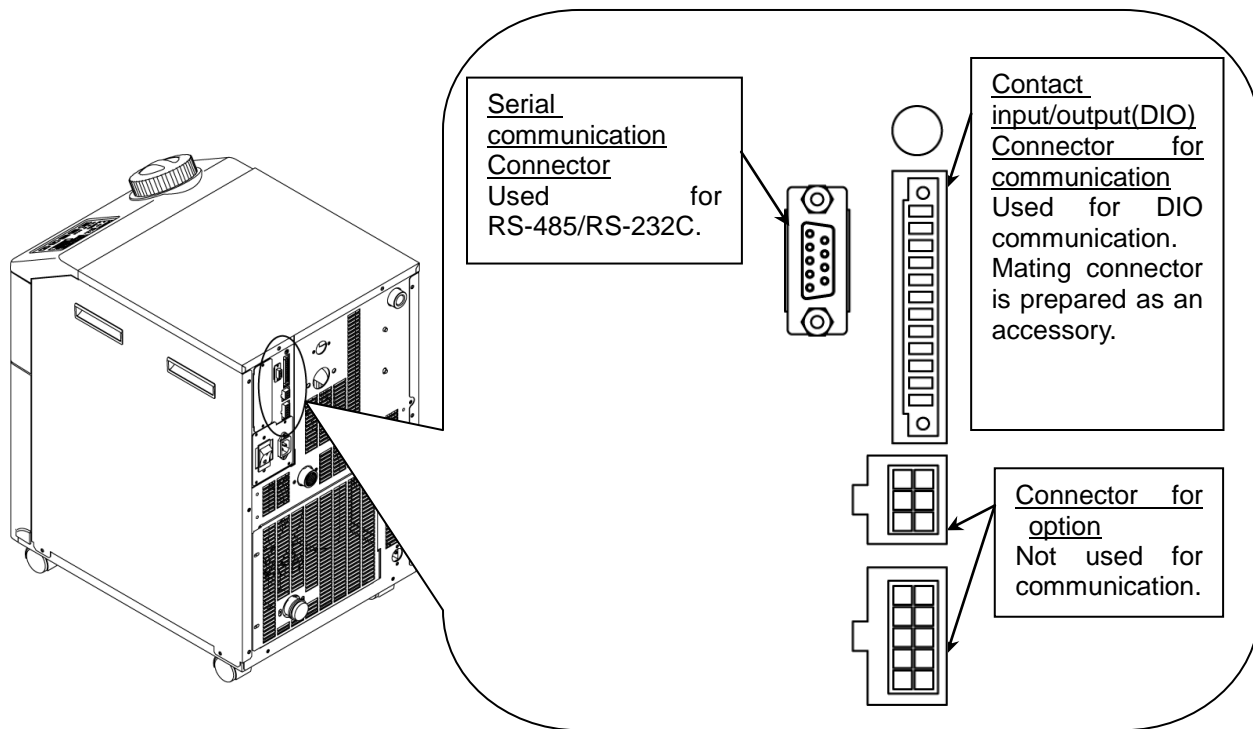

Fig 1.2-1 Communication port (HRS012-***-*, HRS018-***-*, HRS024-***-20-*, HRS030-***-20-*, HRS040-***-20-*)

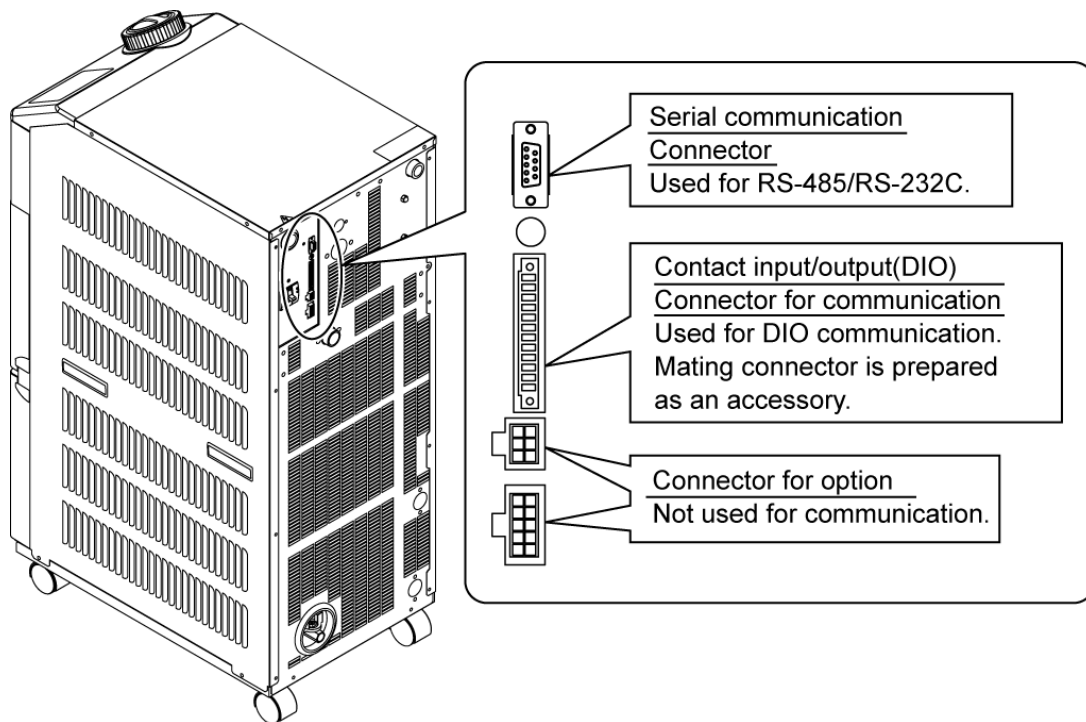

Fig 1.2-2 Communication port (HRS050-***-20-*, HRS060-***-20-*)

1.3 Key operations

Fig 1.3-1 “Key operation (1/2)” and
 Fig 1.3-2 “Key operation (2/2)” show the operation of keys of the thermo-chiller.
 This manual explains the “Communication setting menu”.

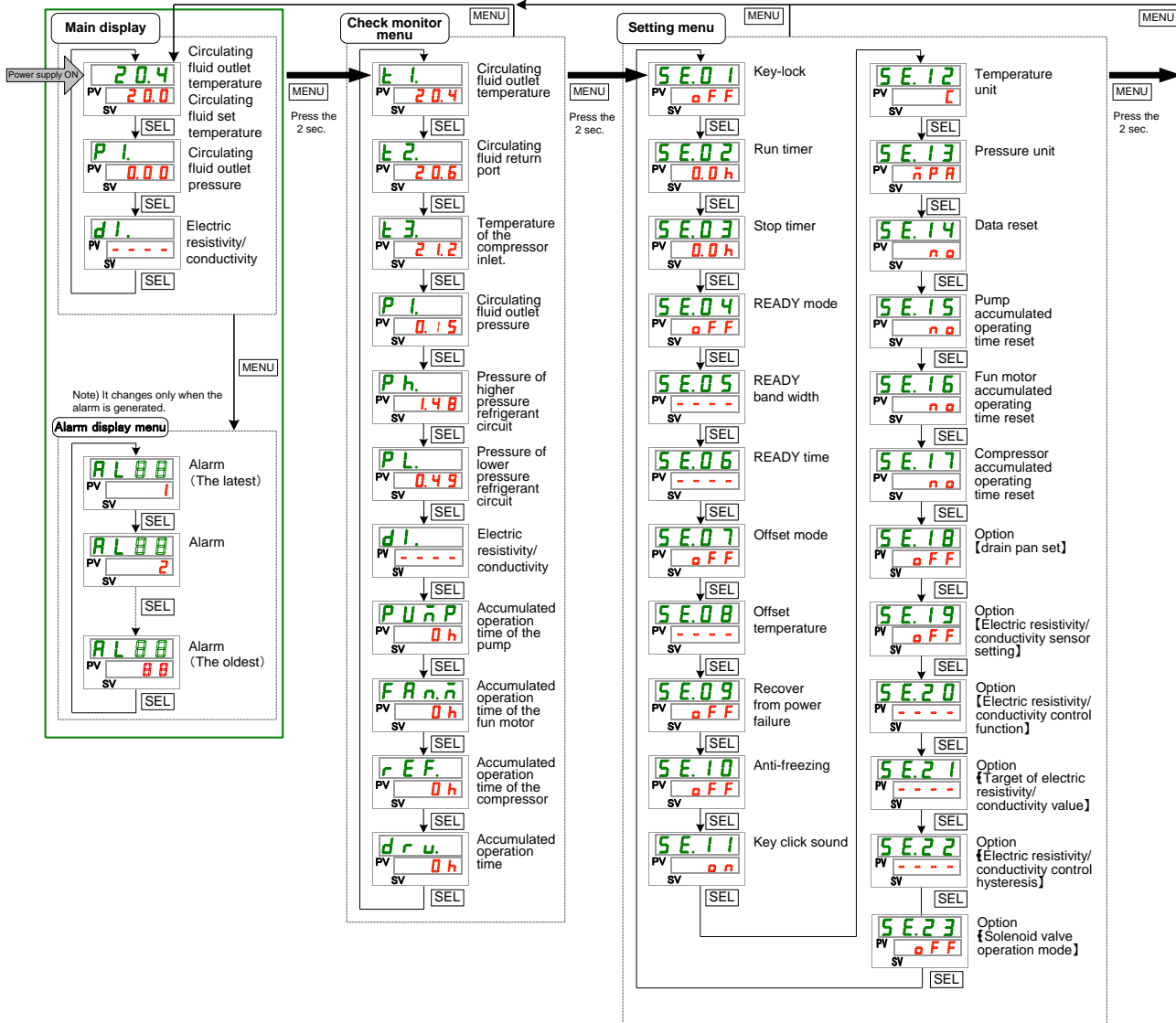

Fig 1.3-1 Key operation (1/2)

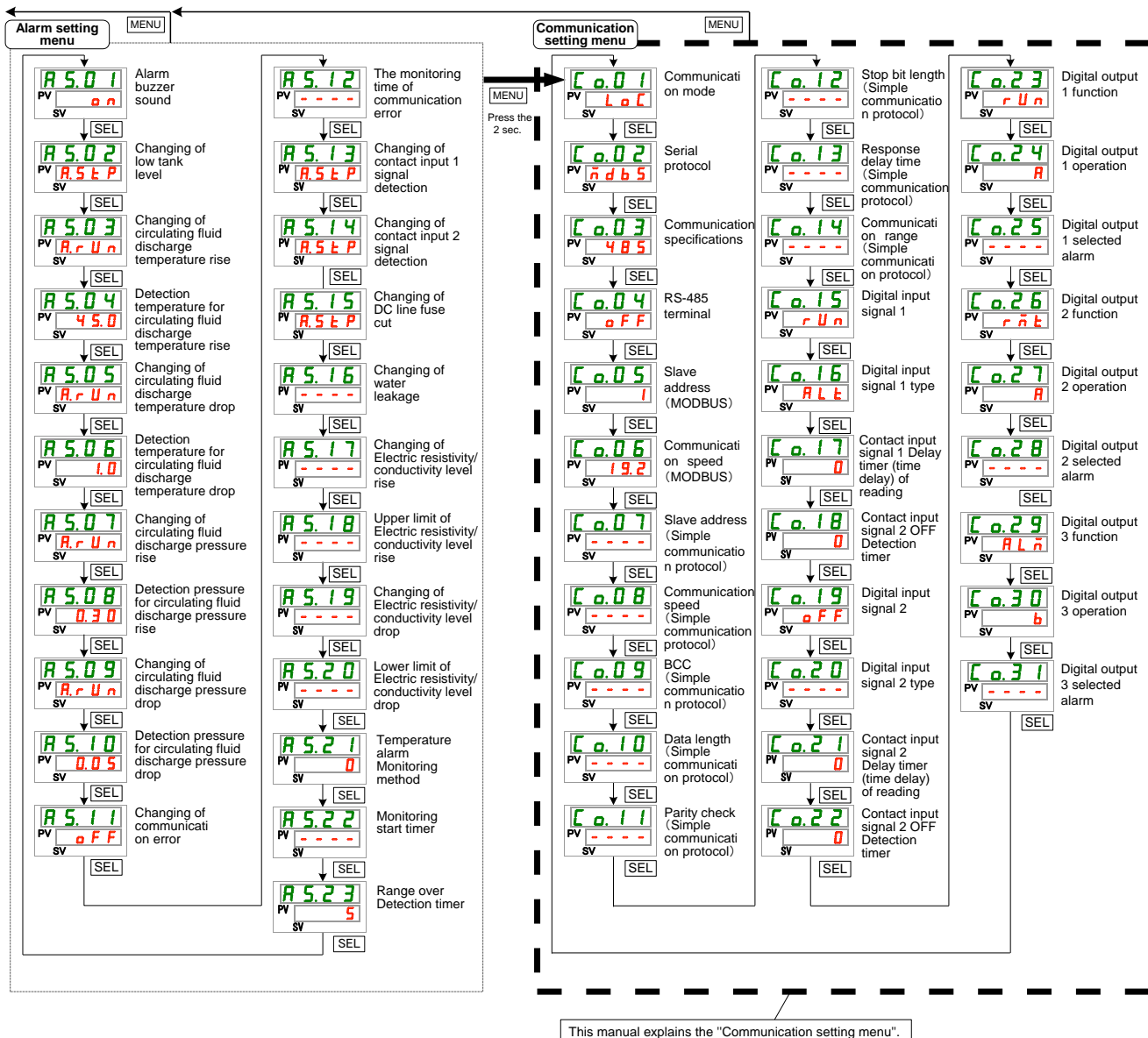

Fig 1.3-2 Key operation (2/2)

1.4 Parameters

Table 1.4-1 "Parameters" explains the parameters of the 「communication setting menu」.

Table 1.4-1 Parameters

Display	Item	Default setting	Reference page	Category	
[0.01]	Communication mode	LOC	2.4 4.3 5.3	Communication setting menu	
[0.02]	Serial communication	Serial protocol	4.3 5.3		
[0.03]		Communication specifications	4.3 5.3		
[0.04]		RS-485 terminal	4.3 5.3		
[0.05]		Modbus	Slave address		4.3
[0.06]			Communication speed		
[0.07]		Simple communication protocol	Slave address		5.3
[0.08]			Communication speed		
[0.09]			BCC		
[0.10]			Data length		
[0.11]			Parity check		
[0.12]			Stop bit length		
[0.13]			Response delay time		
[0.14]		Communication range	RW		
[0.15]		Contact input/output communication	Contact input signal 1		2.4
[0.16]	Contact input signal 1 type				
[0.17]	Contact input signal 1 delay timer (time delay) of reading				
[0.18]	Contact input signal 1 OFF detection timer				
[0.19]	Contact input signal 2				
[0.20]	Contact input signal 2 type				
[0.21]	Contact input signal 2 delay timer (time delay) of reading				
[0.22]	Contact input signal 2 OFF detection timer				
[0.23]	Contact output 1 function				
[0.24]	Contact output 1 operation				
[0.25]	Selected for contact output 1				
[0.26]	Contact output 2 function				
[0.27]	Contact output 2 operation				
[0.28]	Selected for contact output 2.				
[0.29]	Contact output 3 function				
[0.30]	Contact output 3 operation				
[0.31]	Selected for contact output 3				

Chapter 2 Contact input/output communication

The device is equipped with a terminal which runs/stops the product. It is also equipped with a terminal which picks up operation signals, alarm signals and setting condition.

The device starts contact input/output communication according to the setting of the operation display panel. Contact input/output communication can be customized by changing the settings. Table 2-1 "Customizable content" shows the contents which can be changed by the operation display panel.

Table 2-1 Customizable content

Signal	Can be changed
Contact input/output signal (2pcs.)	Signal configuration (Alternate/Momentary)
Contact input/output signal (3pcs.)	Type of signal, signal operation (N.O type / N.C type)

2.1 Precautions for communication

2.1.1 Precautions wiring communication

○Communication wiring

A communication cable that connects the product and customer system is not included with the product. Please prepare a cable, referring to 2.3 "Terminal block explanation (The connector is included.) In order to avoid malfunction, do not connect to any place other than those shown in 2.3 "Terminal block explanation.

○Power supply

To use the power of the product, the total load current must be 500mA or less.

If the load is 500mA or more, the internal fuse is cut to protect the product and the alarm [AL21 DC line fuse cut] is generated. Refer to the "Installation / Operation" of the operation manual for alarms.

Optional parts needs to be adjusted so that the total load is 500mA or less referring the table below.

Table 2-1-1 Current consumption of optional parts

No.	Name	Part NO	Current consumption
1	Drain pan set(with water leakage sensor)	HRS-WL001	25mA
2	Drain pan set(with water leakage sensor)	HRS-WL002	25mA
3	Electric resistivity sensor set	HRS-DI001	100mA
4	Electric conductivity sensor set	HRS-DI008	100mA

2.1.2 Precautions after wiring and before communication

○ Check or set the communication mode by the operation display panel.

- Communication mode shall be DIO.

Other modes can perform reading, but only DIO mode can perform writing.

2.2 Communication specification

Table 2.2-1 DIO Communication specification

Item		Specification
Connector type (for this product)		MC 1,5/12-GF-3,5
Contact input signal	Insulation system	Photo coupler
	Rated input voltage	DC24V
	Used input voltage	DC 21.6V to 26.4V
	Rated input current	5mA TYP
	Input signal	4.7kΩ
Contact output signal	Rated load voltage	AC48V or less/DC30V or less
	Maximum load current	AC/DC 500mA (Resistance load)
Output voltage		DC24V±10% 0.5A MAX

2.3 Terminal block explanation

This part explains the terminal block of the contact input/output communication. A communication cable that connects the product and customer system is not included with the product. Prepare a cable, referring to Table 2.3-1 and Fig 2.3-1. Use the connector included as an accessory.

Table 2.3-1 Terminal explanation

Terminal no	Application	Division	Default setting	Setting available
1	Common of contact output signal 3			
2	Contact output signal 3	Output	Alarm signal (N.C type)	○
3	Common of contact output signal 2			
4	Contact output signal 2	Output	Remote signal (N.O type)	○
5	Common of contact output signal 1			
6	Contact output signal 1	Output	Run status signal (N.O type)	○
7	Common of contact input signal 2			
8	Contact input signal 2	Input	None	○
9	Common of contact input signal 1			
10	Contact input signal 1	Input	Run/stop signal (Alternate)	○
11	24V COM output	Output		
12	DC 24V output	Output		

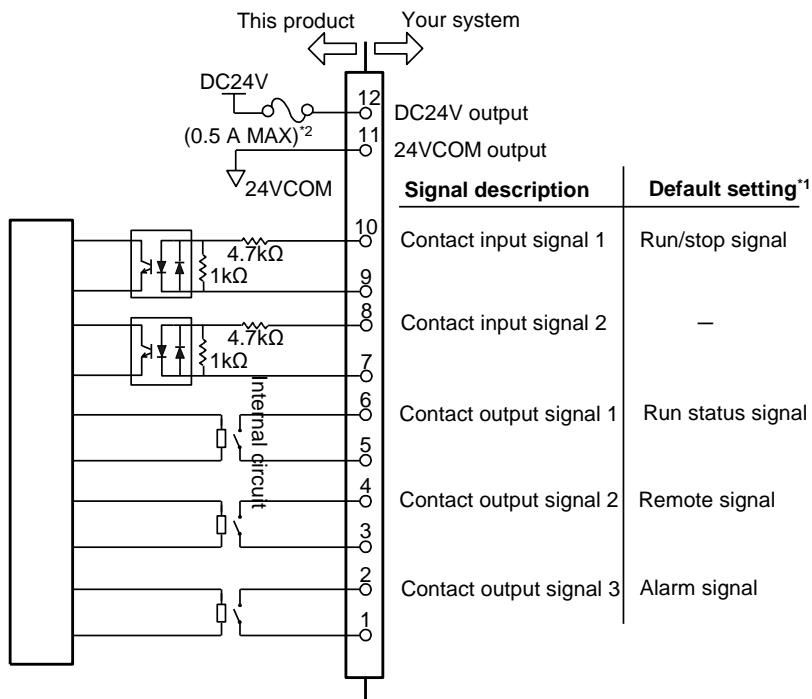

*1 The pin numbers and output signals can be set by user. For details, refer to the [2.4 Setting and checking]

*2 When using with optional accessories, depending on the accessory, the allowable current of 24 VDC devices will be reduced. Refer to the operation manual of the optional accessories for details.

Fig 2.3-1 Example of connector connection

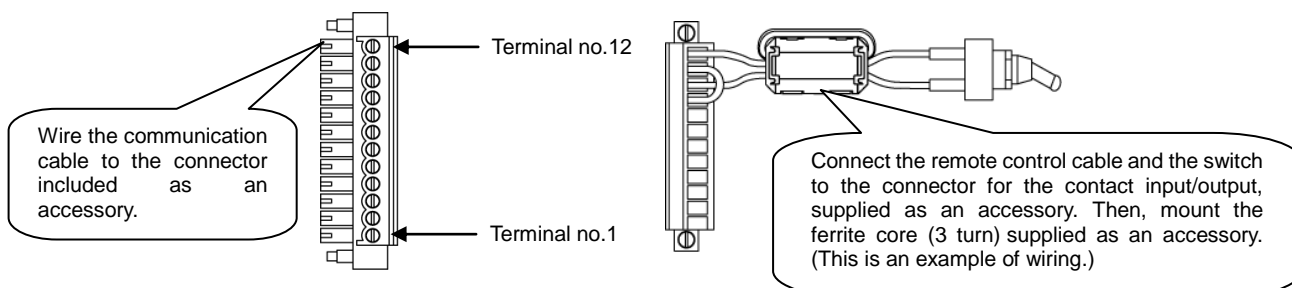

Fig 2.3-2 Attached connector and terminal no (Example)

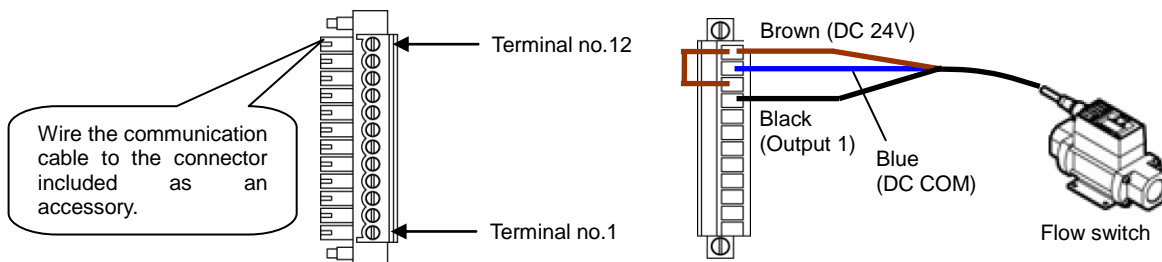

Fig 2.3-3 Wiring of the external switch (NPN open collector output) (Example)

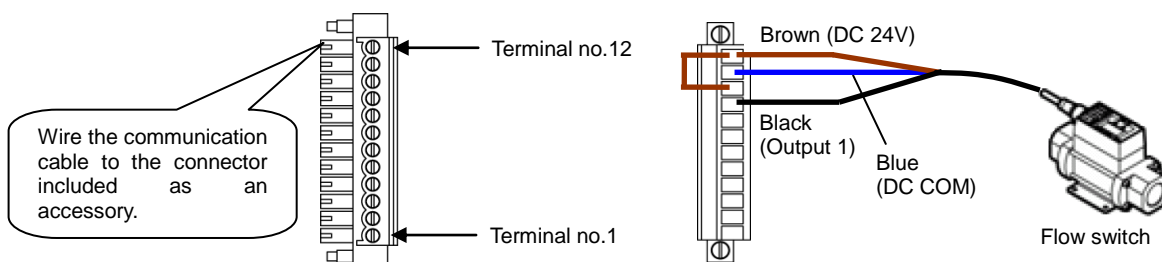

Fig 2.3-4 Wiring of the external switch (PNP open collector output) (Example)

2.4 Setting and checking

2.4.1 Setting and checking

The table below explains the setting items of the contact input/output signal and the initial values.

Table 2.4-1 List of set communication items

Display	Item	Contents	Default setting
[o.01]	Communication mode	Sets communication mode of this product.	LOC
[o.15]	Contact input signal 1	Setting contact input signal 1 of the contact input/output communication.	RUN
[o.16]	Contact input signal 1 type	Setting input type of contact input signal 1 of the contact input/output communication. [----] is displayed when the setting of contact input signal 1 is OFF.	ALT
[o.17]	Contact input signal 1 delay timer of reading	Sets the delay timer of reading of contact input signal 1 of the contact input/output communication. Used when the setting of the contact input signal 1 is SW_A or SW_B. [----] is displayed when the setting of the contact input signal 1 is not SW_A or SW_B.	-
[o.18]	Contact input signal 1 OFF Detection timer	Sets the OFF detection timer of contact input signal 1 of the contact input/output communication. Used when the setting of the contact input signal 1 is SW_A or SW_B. [----] is displayed when the setting of the contact input signal 1 is not SW_A or SW_B.	-
[o.19]	Contact input signal 2	Setting contact input signal 2 of the contact input/output communication.	OFF
[o.20]	Contact input signal 2 type	Setting input type of contact input signal 2 of the contact input/output communication. [----] is displayed when the setting of contact input signal 2 is OFF.	ALT
[o.21]	Contact input signal 2 delay timer of reading	Sets the delay timer of reading of contact input signal 2 of the contact input/output communication. Used when the setting of the contact input signal 2 is SW_A or SW_B [----] is displayed when the setting of the contact input signal 2 is not SW_A or SW_B.	-
[o.22]	Contact input signal 2 OFF Detection timer	Sets the OFF detection timer of contact input signal 2 of the contact input/output communication. Used when the setting of the contact input signal 2 is SW_A or SW_B. [----] is displayed when the setting of the contact input signal 2 is not SW_A or SW_B.	-
[o.23]	Contact output 1 function	Setting output signal function of contact output 1 of the contact input/output communication.	RUN
[o.24]	Contact output 1 operation	Setting output signal operation of contact output 1 of the contact input/output communication.	A
[o.25]	Contact output 1 selected alarm	Setting selected alarm of contact output 1 of the contact input/output communication. [----] is displayed when the setting of the output signal of contact output1 is not selected alarm signal.	AL.01
[o.26]	Contact output 2 function	Setting output signal function of contact output 2 of the contact input/output communication.	RMT
[o.27]	Contact output 2 operation	Setting output signal operation of contact output 2 of the contact input/output communication.	A
[o.28]	Contact output 2 selected alarm	Setting selected alarm of contact output 2 of the contact input/output communication. [----] is displayed when the setting of the output signal of contact output2 is not selected alarm signal.	AL.01
[o.29]	Contact output 3 function	Setting output signal function of contact output 3 of the contact input/output communication.	ALM
[o.30]	Contact output 3 operation	Setting output signal operation of contact output 3 of the contact input/output communication.	B
[o.31]	Contact output 3 selected alarm	Setting selected alarm of contact output 3 of the contact input/output communication. [----] is displayed when the setting of the output signal of contact output3 is not selected alarm signal.	AL.01

2.4.2 Setting and checking

Communication mode Setting and checking

1. Press and hold the [MENU] key for 2 sec.

Repeat pressing the key until the setting screen for communication mode [Co.01] appears on the digital display.

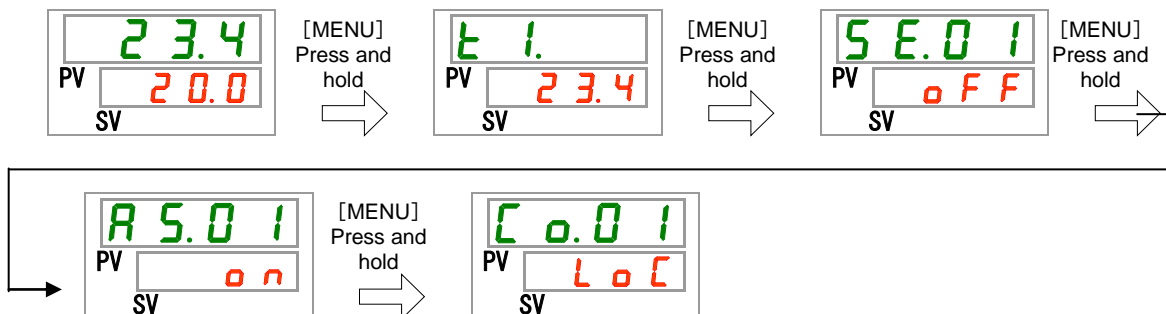

2. Select [LOC] from the [▲] key, and confirm by pressing “SEL”.



Table 2.4-2 Set values

Set values	Explanation	Default setting
LoC	Sets LOCAL mode.	○
dIo	Sets DIO mode.*1	
SEr	Sets SERIAL mode.*2	

*1: When the setting of the contact input 1 is “External switch signal”, “DIO mode” cannot be set.

*2: If the serial protocol is “Simple communication protocol 2” and the contact input 1 is “external switch signal” or contact input 2 is “remote signal”, “SERIAL mode” cannot be set.

CAUTION



If the communication mode is set to [DIO] first while the operating signal is input, the product will start and feed the circulating fluid before the details are set.
For safety, set the communication mode to [DIO] after carrying out the setting below.

Contact input signal1 Setting and checking

- 3.** Display the screen of contact input signal 1 by pressing the [SEL] key several times.
The set screen of contact input signal 1 is displayed on the digital display.

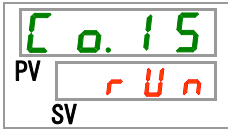

- 4.** Select contact input signal 1 from the table below with [▲] key or [▼] key, and confirm by pressing “SEL”.

Table 2.4-3 Set values

Set values	Explanation	Default setting
oFF	Without input signal	
rUn	Input of run/Stop signal	○
SH_A	External switch signal input(N.O. type) ^{*3,*4}	
SH_b	External switch signal input (N.C. type) ^{*3,*4}	

*3: When the setting of the communication mode is “DIO mode”, “External switch signal” cannot be set.

*4: When the setting of the communication mode is “SEIRAL mode” and the protocol setting is “Simplified communication protocol 2”, “External switch signal” cannot be set.

Contact input signal 1 type Setting and checking

- 5.** Press the [SEL] key once.
The set screen of contact input signal 1 type is displayed on the digital display.

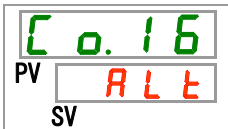

- 6.** Select contact input signal 1 type from the table below with [▲] key or [▼] key, and confirm by pressing “SEL”.

Table 2.4-4 Set values

Set values	Explanation	Default setting
---	Setting/checking are not available if the setting of contact input signal 1 is OFF.	
ALt	Alternate signal	○
n̄t	Momentary signal	
n̄t	Momentary signal ^{*5}	

*5: Used when the setting of the contact input 1 is “Operation stop signal input”.

Contact input signal 1 delay timer of reading Setting and checking

7. Press the [SEL] key once.

The set screen of the contact input signal 1 delay timer of reading is displayed on the digital display.



8. Select contact input signal 1 delay timer of reading from the table below with [▲] key or [▼] key, and confirm by pressing “SEL”.

Table 2.4-5 Set values

Set value	Explanation	Default setting
----	Setting and checking are not available unless contact input signal 1 is external switch signal input (N.O. type or N.C. type).	
0 to 300	Setting of contact input signal 1 delay timer of reading. Set range is 0 to 300 sec.	0

Contact input signal 1 OFF detection timer Setting and checking

9. Press the [SEL] key once.

The set screen of the contact input signal 1 OFF detection timer is displayed on the digital display.

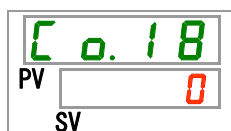

10. Select contact input signal 1 OFF detection timer from the table below with [▲] key or [▼] key, and confirm by pressing “SEL”.

Table 2.4-6 Set values

Set value	Explanation	Default setting
----	Setting and checking are not available unless contact input signal 1 is external switch signal input (N.O. type or N.C. type).	
0 to 10	Setting of contact input signal 1 OFF detection timer Set range is 0 to 10sec.	0

Contact input signal 2 Setting and checking

11. Press the [SEL] key once.

The set screen of contact input signal 2 is displayed on the digital display.

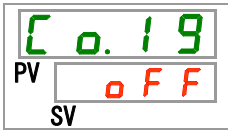

12. Select contact input signal 2 from the table below with [▲] key or [▼] key, and confirm by pressing "SEL".

Table 2.4-7 Set values

Set values	Explanation	Default setting
OFF	Without input signal	○
run	Input of run/stop signal	
SH-A	External switch signal input(N.O. type)	
SH-b	External switch signal input (N.C. type)	
remote	Remote signal*6	

*6: When the setting of the serial protocol is "Simplified communication protocol 2", "Remote signal" cannot be set.

Contact input signal 2 type Setting and checking

13. Press the [SEL] key once.

The set screen of contact input signal 2 type is displayed on the digital display.

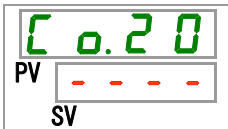

14. Select contact input signal 2 type from the table below with [▲] key or [▼] key, and confirm by pressing "SEL".

Table 2.4-8 Set values

Set values	Explanation	Default setting
----	Setting/checking are not available if the setting of contact input signal 2 is OFF.	
ALT	Alternate signal	○
momentary	Momentary signal*7	

*7: Can be set when the setting of contact input signal 2 is "Run/Stop signal input" or "Remote signal"

Contact input signal 2 delay timer of reading Setting and checking

15. Press the [SEL] key once.

The set screen of contact input signal 2 delay timer of reading is displayed on the digital display.

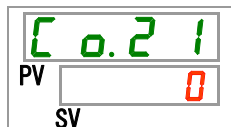

16. Select contact input signal 2 delay timer of reading from the table below with [▲] key or [▼] key, and confirm by pressing “SEL”.

Table 2.4-9 Set values

Set values	Explanation	Default setting
<div style="border: 1px solid black; padding: 2px; display: inline-block;">0</div> to <div style="border: 1px solid black; padding: 2px; display: inline-block;">300</div>	Setting of contact input signal 2 delay timer of reading. Set range is 0 to 300 sec.	<div style="border: 1px solid black; padding: 2px; display: inline-block;">0</div>

Contact input signal 2 OFF detection timer Setting and checking

17. Press the [SEL] key once.

The set screen of contact input signal 2 OFF detection timer is displayed on the digital display.

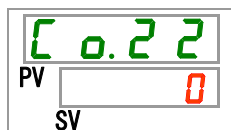

18. Select contact input signal 2 OFF detection timer from the table below with [▲] key or [▼] key, and confirm by pressing “SEL”.

Table 2.4-10 Set values

Set values	Explanation	Default setting
- - - -	Setting and checking are not available unless contact input signal 2 is external switch signal input(N.O. type or N.C. type).	
<div style="border: 1px solid black; padding: 2px; display: inline-block;">0</div> to <div style="border: 1px solid black; padding: 2px; display: inline-block;">10</div>	Setting of contact input signal 2 OFF detection timer. Set range is 0 to 10 sec.	<div style="border: 1px solid black; padding: 2px; display: inline-block;">0</div>

19. Press the [SEL] key once.

The set screen of contact output signal 1 function is displayed on the digital display.

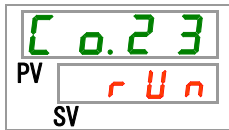

20. Select contact output signal 1 function from the table below with [▲] key or [▼] key, and confirm by pressing “SEL”.

Table 2.4-11 Set values

Set values	Explanation	Default setting
oFF	Without output signal	
rUn	Signal of operating status is output	○
rñt	Signal of remote status is output	
rdY	Signal for completion of preparation (TEMP READY)	
AStP	Signal for the status of the operation stop alarm is output	
A.rUn	Signal for the status of the operation continue alarm is output	
ALñ	Signal for the alarm status is output	
ASEL	Signal for selected alarm status is output	
oñtñ	Signal for Run timer set status is output	
oF.tñ	Signal for Stop timer set status is output	
P.rSt	Signal for the recovery from power failure is output	
F.P.	Signal for anti-freezing setting is output	
INP1	Pass through signal of contact input signal 1	
INP2	Pass through signal of contact input signal 2	
AFIL	Signal output during automatic fluid filling	

21. Press the [SEL] key once.

The set screen of contact output signal 1 operation is displayed on the digital display.

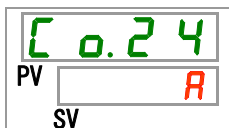

22.Select contact output signal 1 operation from the table below with [▲] key or [▼] key, and confirm by pressing “SEL”.

Table 2.4-12 Set values

Set values	Explanation	Default setting
A	N.O type	○
b	N.C type	

Contact output 1 selected alarm Setting and checking

23.Press the [SEL] key once.

The set screen of digital output 1 selected alarm is displayed on the digital display.

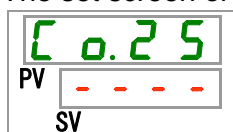

24.Select contact output 1 selected alarm from the table below with [▲] key or [▼] key, and confirm by pressing “SEL”.

Table 2.4-13 Set values

Set values	Explanation	Default setting
- - - -	Setting/checking are not available unless the function setting of contact output 1 is selected alarm status signal.	
AL.01 to AL.36	Sets selection alarm. Set range is AL.01 to AL.36.	AL.01

Contact output 2 function Setting and checking

25.Press the [SEL] key once.

The set screen of contact output 2 function is displayed on the digital display.

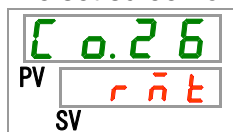

26.Select contact output 2 function from the table below with [▲] key or [▼] key, and confirm by pressing “SEL”.

Table 2.4-14 Set values

Set values	Explanation	Default setting
OFF	Without output signal	
run	Signal of operating status is output	
remote	Signal of remote status is output	○
rdy	Signal for completion of preparation (TEMP READY)	
ALSP	Signal for the status of the operation stop alarm is output	
RRUN	Signal for the status of the operation continue alarm is output	
ALn	Signal for the alarm status is output	
ASEL	Signal for selected alarm status is output	
ontn	Signal for Run timer set status is output	
of.tn	Signal for Stop timer set status is output	
PRSE	Signal for the recovery from power failure is output	
F.P.	Signal for anti-freezing setting is output	
INP1	Pass through signal of contact input signal 1	
INP2	Pass through signal of contact input signal 2	
R.FILL	Signal output during automatic fluid filling	

Contact output 2 operation Setting and checking

27.Press the [SEL] key once.

The set screen of contact output 2 operation is displayed on the digital display.

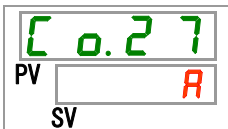

28.Select contact output 2 operation from the table below with [▲] key or [▼] key, and confirm by pressing “SEL”.

Table 2.4-15 Set values

Set values	Explanation	Default setting
A	N.O type	○
b	N.C type	

29. Press the [SEL] key once.

The set screen of contact output 2 selected alarm is displayed on the digital display.

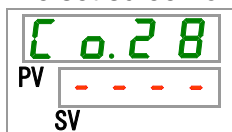

30. Select contact output 2 selected alarm from the table below with [▲] key or [▼] key, and confirm by pressing "SEL".

Table 2.4-16 Set values

Set values	Explanation	Default setting
----	Setting/checking are not available unless the function setting of contact output 2 is selected alarm status signal.	
AL.01 to AL.36	Sets selection alarm. Set range is AL.01 to AL.36.	AL.01

31. Press the [SEL] key once.

The set screen of contact output 3 function is displayed on the digital display.

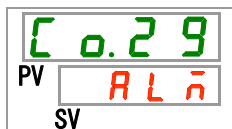

32.Select contact output 3 function from the table below with [▲] key or [▼] key, and confirm by pressing “SEL”.

Table 2.4-17 Set values

Set values	Explanation	Default setting
o F F	Without output signal	
r U n	Signal of operating status is output	
r n t	Signal of remote status is output	
r d y	Signal for completion of preparation (TEMP READY)	
R. S t P	Signal for the status of the operation stop alarm is output	
R. r U n	Signal for the status of the operation continue alarm is output	
A L n	Signal for the alarm status is output	○
R. S E L	Signal for selected alarm status is output	
o n. t n	Signal for Run timer set status is output	
o F. t n	Signal for Stop timer set status is output	
P. r S t	Signal for the recovery from power failure is output	
F. P.	Signal for anti-freezing setting is output	
I n P 1	Pass through signal of contact input signal 1	
I n P 2	Pass through signal of contact input signal 2	
R. F I L	Signal output during automatic fluid filling	

Contact output 3 operation Setting and checking

33.Press the [SEL] key once.

The set screen of contact output 3 operation is displayed on the digital display.

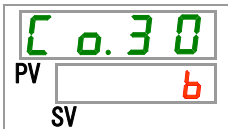

34.Select contact output 3 operation from the table below with [▲] key or [▼] key, and confirm by pressing “SEL”.

Table 2.4-18 Set values

Set values	Explanation	Default setting
A	N.O type	
b	N.C type	○

Contact output 3 selected alarm Setting and checking

35. Press the [SEL] key once.

The set screen of contact output 3 selected alarm is displayed on the digital display.



36. Select contact output 3 selected alarm from the table below with [▲] key or [▼] key, and confirm by pressing “SEL”.

Table 2.4-19 Set values

Set values	Explanation	Default setting
----	Setting/checking are not available unless the function setting of contact output 1 is selected alarm status signal.	
AL.01 to AL.36	Sets selection alarm. Set range is AL.01 to AL.36.	AL.01

Communication mode Setting and checking

37. Press the [SEL] key once.

The set screen of communication mode is displayed on the digital display.



38. Select communication mode [DIO] from the table below with [▲] key or [▼] key, and confirm by pressing “SEL”.

Table 2.4-20 Set values

Set value	Explanation	Default setting
LoC	Sets LOCAL mode.	○
dIo	Sets DIO mode.	
SER	Sets SERIAL mode.	

2.5 Contact input signal

There are two contact input signals. As the default condition, contact input signal 1 is used for run/stop signal (signal type: alternate), and contact input signal 2 is not used. The input signals can be customized depending on the customer's application.

Table 2.5-1 Contact input signal

	Class of signal		Signal configuration		Timer		Default setting
	Description	Display	Description	Display	Delay timer of reading	OFF detection	
Contact input signal 1	Run/stop signal	RUN	Alternate	ALT	-	-	○
			Momentary	MT	-	-	
	External switch signal input (N.O)	SW_A	Alternate	ALT	Used	Used	
	External switch signal input (N.C)	SW_B	Alternate	ALT	Used	Used	
	Without input signal	OFF	—	—	-	-	
Contact input signal 2	Run/stop signal	RUN	Alternate	ALT	-	-	
			Momentary	MT	-	-	
	External switch signal input (N.O)	SW_A	Alternate	ALT	Used	Used	
	External switch signal input (N.C)	SW_B	Alternate	ALT	Used	Used	
	Remote signal	RMT	Alternate	ALT	-	-	
Momentary	MT	-	-				
	Without input signal	OFF	—	—	-	-	○

2.5.1 Run/stop signal · Remote signal

1) Run/stop signal (Signal type: Alternate)

The product keeps operating while the input signal from the customer is ON.

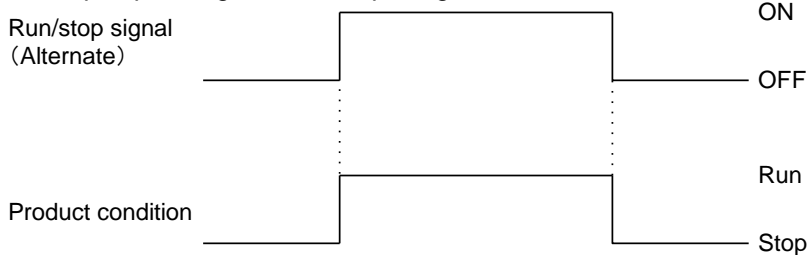

2) Run/stop signal (Signal type: Momentary)

The state changes when the input signal from the customer goes OFF. This signal operates while the product is stopped, and stops while the product is being operated. Maintain the ON condition for 300ms or longer.

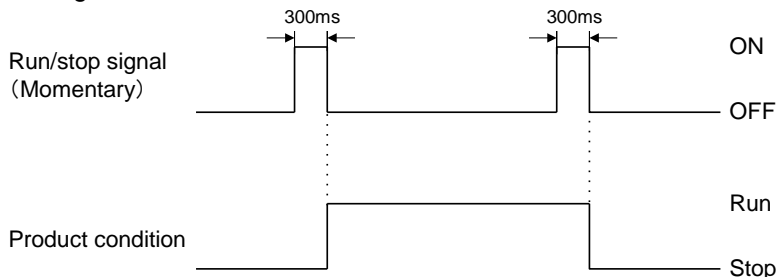

- 3) Remote signal (Signal type: Alternate)
The product becomes DIO REMOTE while the input signal from the customer is ON.

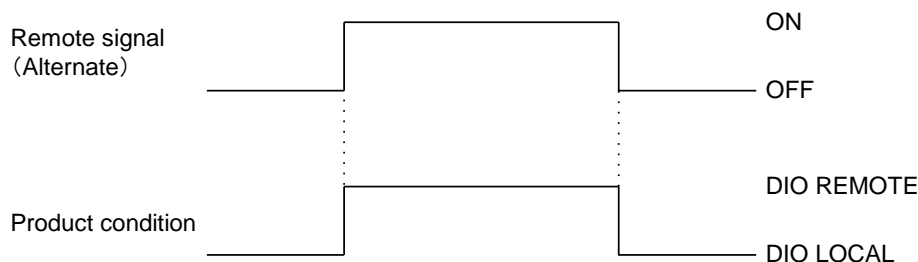

- 4) Remote signal (Signal type: Momentary)
The state changes when the input signal from the customer goes OFF. If DIO LOCAL is set, it is switched to DIO REMOTE. If DIO REMOTE, it is switched to DIO LOCAL. Maintain the ON condition for 300ms or longer.

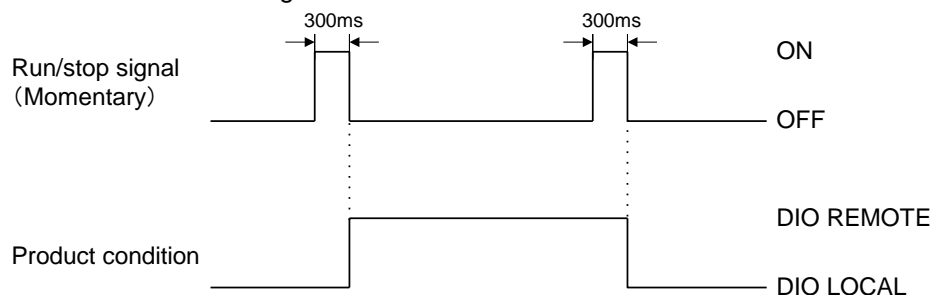

- 5) Digital input signal 1 is for Run/Stop signal (Signal type: Alternate), digital input signal 2 is for external switch signal (N.O. type)
Refer to Chapter 2.5.2 for details of the external switch.

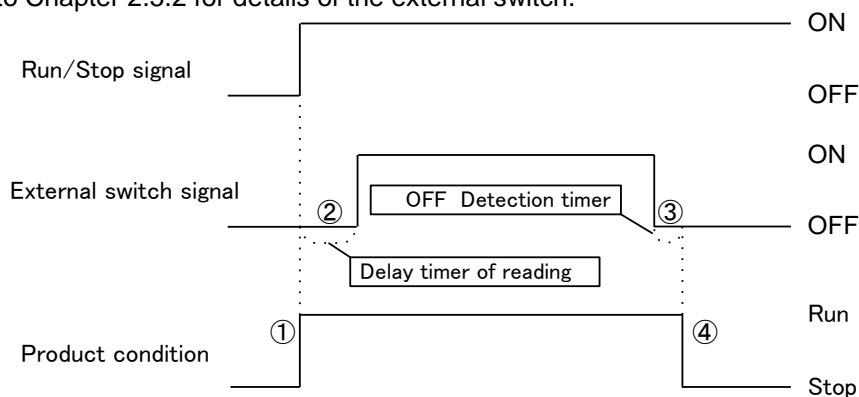

- ① The product starts operation when the Run/Stop signal from the user is turned on.
 - ② It reads the signal of the external switch signal (N.O type) after the time which has been set for the delay timer of reading.
The factory default setting of the delay timer of reading is 0sec. Refer to 2.4.2 for setting. .
 - ③ When the external switching signal (N.O. type) has been turned off for the time set for OFF detection timer, it is recognized as OFF.
The factory default setting of the OFF detection timer is 0sec. Refer to 1.4.2 for setting.
 - ④ AL32 contact input 2 signal detection alarm is generated. The operation of the product stops.
"Operation stop" is the default setting for AL32. The product can be set to continue operation or not to detect the alarm. Refer to the "Installation / Operation" manual for details.
- * The product stops operation when the Run/Stop signal is turned off during operation. Afterwards, the alarm is not generated even if the external switch signal (N.O type) is turned off.
- 6) Input signal is not connected to either contact input signal 1 or contact input signal 2.
This product cannot be controlled by the contact input.
 - 7) Remote signal is connected to either contact input signal 1 or contact input signal 2.
This product cannot be controlled by the contact input.

2.5.2 Signal of the external switch

This product can be monitored during operation by reading the signal of the external switch prepared by the customer.
 The product stops monitoring when it stops operation.
 This product generates an alarm and stops operating when a problem is detected from the external switch.
 Select the external switch 1 or 2 or both depending on the customer's system. Refer to 2.4.2 for setting.
 The number of monitored external switches depends on the communication mode. Refer to Table 2.5-2
 In the communication mode in which the external switches 1 and 2 are available, two products can be monitored simultaneously. If a problem is detected by one or both external switches, an alarm is generated and the operation stops.
 You can set the product to continue operation or not to detect the alarm. Refer to the "Installation / Operation" manual for details

Table 2.5-2 Cross reference of communication modes and external switch monitoring

	LOCAL	DIO		SERIAL		
		DIO LOCAL	DIO REMOTE	MODBUS	Simple communication protocol pattern	
					1	2
External switch 1	○	×	×	○	○	×
External switch 2	○	○	○	○	○	○

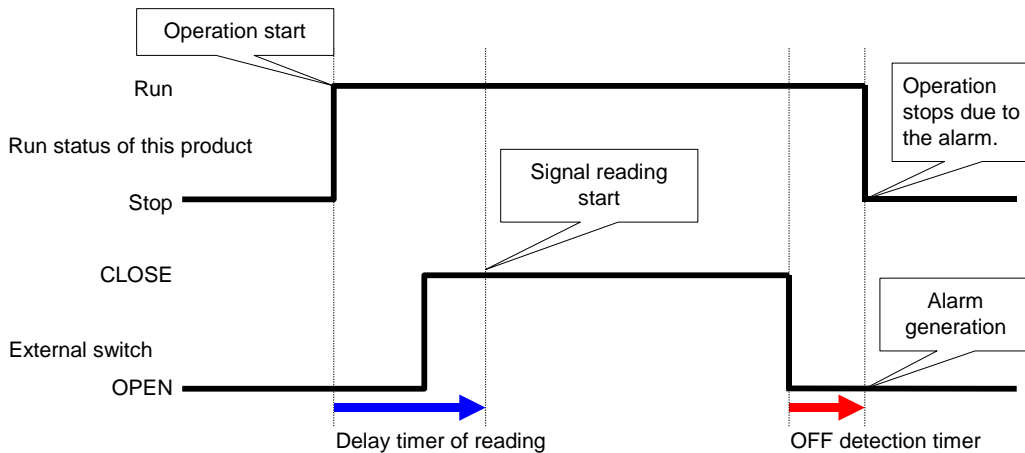

Fig 2.5-1 Timing chart of external switch monitoring

■ Delay timer of reading

If the signal of the external switch prepared by the customer is not closed instantly when the product is operated, set the delay timer for reading. By setting this timer, the external switch monitoring starts after the time set by the delay time of reading since the operation start.

"0" is the default setting. Set a time which is suitable for your environment.

Example) When using a flow switch

When operation is started, it takes time for the fluid to reach the piping and the flow switch to detect the flow. Set the time for the flow switch to start.

■ OFF detection timer

If you do not want the alarm to be generated instantly when the external switch prepared by the customer is in open status, but instead want the alarm to be generated after the switch has been open for a specific time (continuous open status), set the OFF detection timer.

This timer enables the alarm to be generated when the time set for OFF detection time passes after the switch is in OPEN status.

The default setting is 0 sec. Set a time which is suitable for your application.

■ Contact input

N.O type or N.C. type can be selected for the external switch. Set the signal which is suitable for the external switch prepared by the customer.

2.6 Contact output signal

There are three contact output signals. As the default setting, contact output signal 1 is for operating condition (N.O type), contact output signal 2 is for remote signal (N.O type), and contact output signal 3 is for alarm signal (N.C type). Refer to Table 2-6-1. Depending on the product condition, contact output signal is turned on (closed) or turned off (open).

The signals can be customized depending on the customer's application. The Table 2.6-2 shows operation of contact output signal.

[Tips]

All contact output signals are turned off (open) when the power is not supplied.

Table2.6-1 Contact output signal (Default setting)

	Class of signal		Signal configuration		Remarks
	Description	Display	Description	Display	
Contact output signal 1	Run status signal	RUN	N.O type	A	
Contact output signal 2	Remote signal	RMT	N.O type	A	
Contact output signal 3	Alarm signal	ALM	N.C type	B	

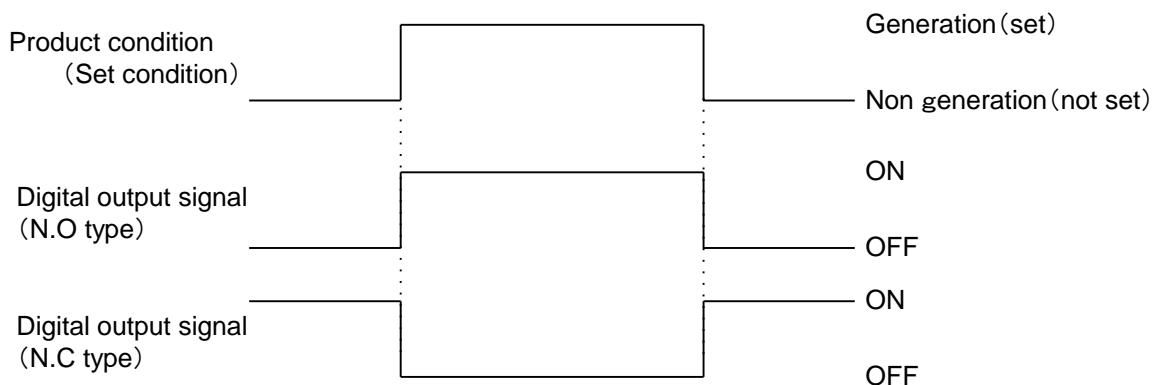

Table 2.6-2 Operation of contact output signal

Class of signal			Operation of contact output signal
Display	Function	Operation	
OFF	Without output	N.O type	Normally, output signal is OFF (open)
		N.C type	Normally, output signal is ON (close)
RUN	Run status signal	N.O type	When the product operates, signal turns on.
		N.C type	When the product operates, signal turns off.
RMT	Remote status signal	N.O type	When the product becomes DIO REMOTE, signal turns on.
		N.C type	When the product becomes DIO LOCAL, signal turns off.
RDY	Signal for completion of preparation (TEMP READY)	N.O type	When the product becomes completion of preparation (TEMP READY), signal turns on.
		N.C type	When the product becomes completion of preparation (TEMP READY), signal turns off.
A.STP	Signal for operation stop alarm	N.O type	When operation stop alarm occurs, signal turns on.
		N.C type	When operation stop alarm occurs, signal turns off.
A.RUN	Signal for continuing operation alarm	N.O type	When continuing operation alarm occurs, signal turns on.
		N.C type	When continuing operation alarm occurs, signal turns off.
ALM	Alarm status signal	N.O type	When alarm occurs, signal turns on.
		N.C type	When alarm occurs, signal turns off.
A.SEL	Signal for selection alarm	N.O type	The signal is turned ON when the selected alarm goes off.
		N.C type	The signal is turned OFF when the selected alarm goes off.
ON.TM	Signal for operation start timer setting	N.O type	The signal is turned ON when the run timer is set.
		N.C type	The signal is turned OFF when the run timer is set.
OF.TM	Signal for operation stop timer setting	N.O type	The signal is turned ON when the stop timer is set.
		N.C type	The signal is turned OFF when the stop timer is set.
P.RST	Signal for power recovery setting	N.O type	The signal is turned ON when the power recovery is set.
		N.C type	The signal is turned OFF when the power recovery is set.
F.P.	Signal for anti-freezing setting	N.O type	The signal is turned ON when the anti-freezing is set.
		N.C type	The signal is turned OFF when the anti-freezing is set.
INP1. *1	Pass through signal of contact input signal 1	N.O type	Outputs the signal which is input to the contact input signal. Input signal is ON → Output signal is ON
		N.C type	Outputs the reverse of the signal which is input to the contact input signal 2. Input signal is OFF → Output signal is ON
INP2*1	Pass through signal of contact input signal 2	N.O type	Outputs the signal which is input to the contact input signal. Input signal is ON → Output signal is ON
		N.C type	Outputs the reverse of the signal which is input to the contact input signal 2. Input signal is OFF → Output signal is ON
A.F.	Signal output during automatic fluid filling	N.O type	Signal is turned ON during automatic fluid filling. *2
		N.C type	Signal is turned OFF during automatic fluid filling. *2

*1: The signal of the product without an option [Automatic filling] also changes.

*2: Signal changes even when option J [Automatic fluid filling] is not selected.

Chapter 3 Serial communication

Serial communication (RS-485/RS232C) enables the remote control of run/start of the product, temperature setting and details of product condition, and alarm condition can be obtained.

The operating state of the product (run/stop) and the temperature setting can be monitored by sending a request message made by the program of the host computer (e.g. PC).

MODBUS communication and simple communication protocol can be selected as the serial communication protocol. This chapter illustrates the common specifications of serial communication. Chapter 4 and 5 illustrate each protocol.

3.1 Precautions wiring communication

○Communication wiring

A communication cable that connects the product and customer system is not included with the product. Please prepare a cable, referring to 3.3 "Connected explanation". In order to avoid malfunction, do not connect to any place other than those shown in 3.3 "Connected explanation".

3.2 Communication specification

Table 3.2-1 Serial communication specification

Item	Specification
Connector type (for the product)	D-sub9P type Female connector(Mounting screw: M2.6×0.45)
Standard	Select from EIA RS-485 / RS-232C
Circuit type Half duplex	Half duplex
Transmission type	Start-stop
Protocol	MODBUS terminal*1 / Simple communication protocol
Terminal resistance	Select from with terminal resistance (120Ω) / Without terminal resistance

■ : Default setting

*1 : Refer to Modicon Co. protocol specifications "PI-MBUS-300 Rev.J".

3.3 Connected explanation

Fig3.3-1 shows the wiring when RS-485 is selected as the communication standard. Fig3.3-2 shows the wiring when RS-232C is selected.

A communication cable that connects the product and customer system is not included with the product. Prepare a cable, referring to Fig3.3-1 or Fig3.3-2.

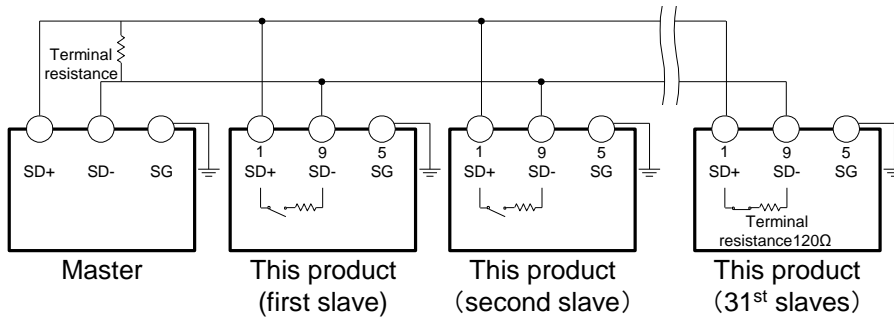

Do not connect any wire to other PIN numbers.

Fig 3.3-1 RS-485 connector connection

(Tips)

- 1 master : 1 product, or 1 master: N products.
 In the latter case, up to 31 products can be connected.
- Both ends of the communication connection (the end nodes) need to be connected to the higher level computer.
- The terminal resistance of this product can be set by the operation display panel. Refer to "4.3.2 Setting and checking", "5.3.2 Setting and checking".

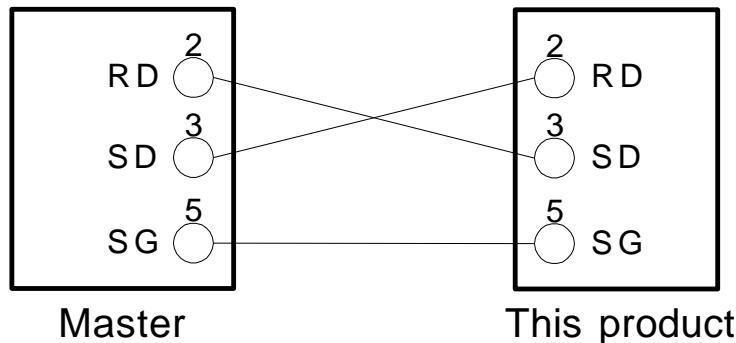

Do not connect any wire to other PIN numbers.

Fig 3.3-2 RS-232C connector connection

Chapter 4 MODBUS communication function

MODBUS protocol is a communication protocol developed by Modicon. It is used to communicate with a PC or PLC.

Register content is read and written by this communication protocol.

This communication has the following features.

- Controls run/stop.
- Sets and reads the circulating fluid set temperature.
- Reads the circulating fluid discharge temperature.
- Reads the condition of the product.
- Reads the alarm generating condition of the product.

Refer to “4.10 Register Map” for the register of the product.

4.1 Precautions for communication

4.1.1 Precautions after wiring and before communication

○ Check or set the each communication setting by the operation display panel.

- The communication specification shall be the customer's communication standard.
- The serial protocol shall be the MODBUS.
- The communication mode shall be the SERIAL mode.

Other modes can perform reading, but only SERIAL mode can perform writing.

○ Check or set the communication parameters using the operation display panel.

Check or set the communication speed so that the product synchronizes with the host computer (master) prepared by the customer.

○ Check the slave address by the operation display panel.

No response is returned when a request message is sent from a slave address other than those set in the product.

4.1.2 Precautions for communicating

○Allow a suitable interval between requests.

To send request messages in series, wait for 100 msec. or longer after receiving a response message from the product before sending the next message.

○Retry (resend request message).

The response may not be returned due to noise. If no message is returned 1sec. after sending a request message, resend the request message.

○If necessary send a read request message to check if it was written correctly.

Message to notify the completion of the process is returned when the action for the written request message is completed.

Send a read request message to confirm if the setting was written as requested.

○Setting limit of circulating fluid temperature

When the circulating fluid set temperature is written by communication, the data is stored in FRAM. When the product restarts, it restarts with the value which was set before the restart. The number of times it is possible to overwrite FRAM is limited. Data is only stored in FRAM when it receives a circulating fluid set temperature which is different from the previous temperatures. Please check how many times it is possible to overwrite FRAM, and avoid unnecessary changes of the circulating fluid set temperature during communication

4.2 Communication specification

Table 4.2-1 Communication specification of MODBUS communication function

Item	Specification
Standard	Select from EIA RS-485/RS-232C
Communication speed	Select from 9600bps/19200bps
Data · bit length	7bit
Stop · bit length	1bit
Data transfer direction	LSB
Parity	Even parity
Letter code	ASCII mode
Slave address set range	Select from 1 to 99 address
Error check	LRC method

 : Default setting

4.3 Setting and checking

4.3.1 Setting and checking items

The table below explains the setting items of the MODBUS communication function and the initial values.

Table 4.3-1 Communication setting items

Display	Item	Contents	Default setting
[0.01]	Communication mode	Sets communication mode of this product.	LOC
[0.02]	Serial protocol	Sets serial communication protocol.	MDBS
[0.03]	Communication specification	Sets standard of the serial communication.	485
[0.04]	RS-485 terminal	Sets of the terminal of RS-485.	OFF
[0.05]	Slave address (MODBUS)	Sets slave address of MODBUS protocol. [----] is displayed when the setting of serial protocol is not MODBUS.	1
[0.06]	Communication speed (MODBUS)	Sets communication speed of MODBUS protocol. [----] is displayed when the setting of serial protocol is not MODBUS.	19.2

4.3.2 Setting and checking

Communication Setting and checking

1. Press and hold the [MENU] key for 2 sec.

Repeat pressing the key until the setting screen for communication mode [Co.01] appears on the digital display.

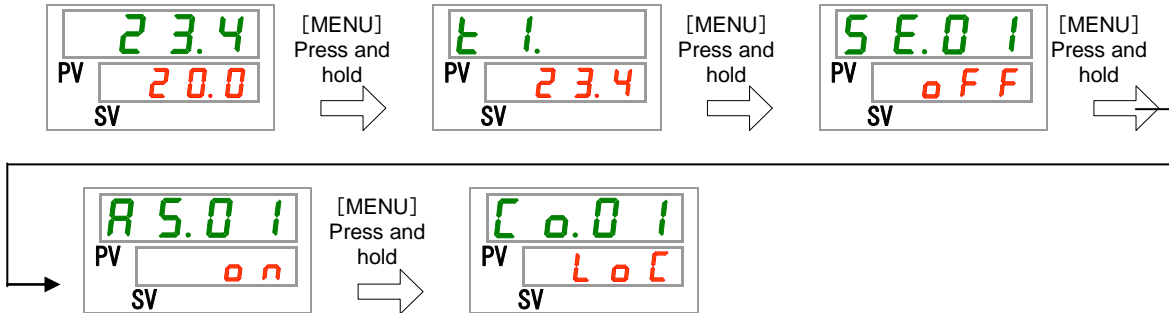

2. Select “SER” from the table below with the ▲key, and confirm with “SEL”.



Table 4.3-2 Set values

Set values	Explanation	Default setting
LoC	Sets LOCAL mode.	○
dIo	Sets DIO mode.	
SEr	Sets SERIAL mode.*1	

*1: If the serial protocol is “Simple communication protocol 2” and the contact input 1 is “external switch signal” or contact input 2 is “remote signal”, “SERIAL mode” cannot be set.

Serial protocol Setting and checking

3. Press the [SEL] key once.

The set screen of serial protocol is displayed on the digital display.

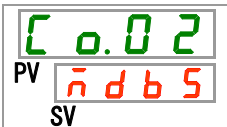

4. Select serial protocol from the table below with [▲] key or [▼] key, and confirm by pressing “SEL”.

Table 4.3-3 Set values

Set values	Explanation	Default setting
Modbus	MODBUS protocol	○
Pr o 1	Simple communication protocol 1	
Pr o 2	Simple communication protocol 2*2	

*2 : When the setting of the contact input 2 is “Remote signal”, “Simplified communication protocol 2” cannot be set.

Communication specification Setting and checking

5. Press the [SEL] key once.

The set screen of communication specification is displayed on the digital display.

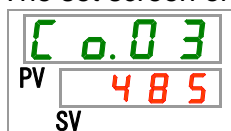

6. Select communication specification from the table below with [▲] key or [▼] key, and confirm by pressing “SEL”.

Table 4.3-4 Set values

Set values	Explanation	Default setting
232C	RS-232C standard	
485	RS-485 standard	○

RS-485 terminal Setting and checking

7. Press the [SEL] key once.

The set screen of RS-485 terminal is displayed on the digital display.

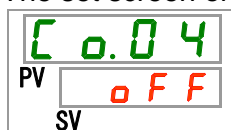

8. Select RS-485 terminal from the table below with [▲] key or [▼] key, and confirm by pressing “SEL”.

Table 4.3-5 Set values

Set values	Explanation	Default setting
0FF	Without terminal	○
0n	With terminal	

Slave addresses (MODBUS) Setting and checking

9. Press the [SEL] key once.

The set screen of slave addresses (MODBUS) is displayed on the digital display.

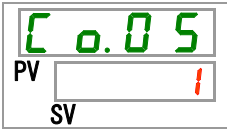

10. Select slave addresses (MODBUS) from the table below with [▲] key or [▼] key, and confirm by pressing “SEL”.

Table 4.3-6 Set values

Set values	Explanation	Default setting
---	Setting/checking are not available unless the serial protocol setting is MODBUS.	
1 to 99	Sets of slave addresses for MODBUS. Set range is 1 to 99.	1

Communication speed (MODBUS) Setting and checking

11. Press the [SEL] key once.

The set screen of communication speed (MODBUS) is displayed on the digital display.

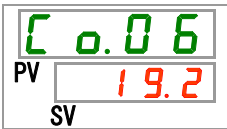

12. Select communication speed (MODBUS) from the table below with [▲] key or [▼] key, and confirm by pressing “SEL”.

Table 4.3-7 Set values

Set values	Explanation	Default setting
---	Setting/checking are not available unless the serial protocol setting is MODBUS.	
9.6	9600bps	
19.2	19200bps	○

4.4 Communication sequence

Starts with a request message from the customer's system (host), and finishes with a response message from the product (slave). This product operates as a slave. It does not send any requests.

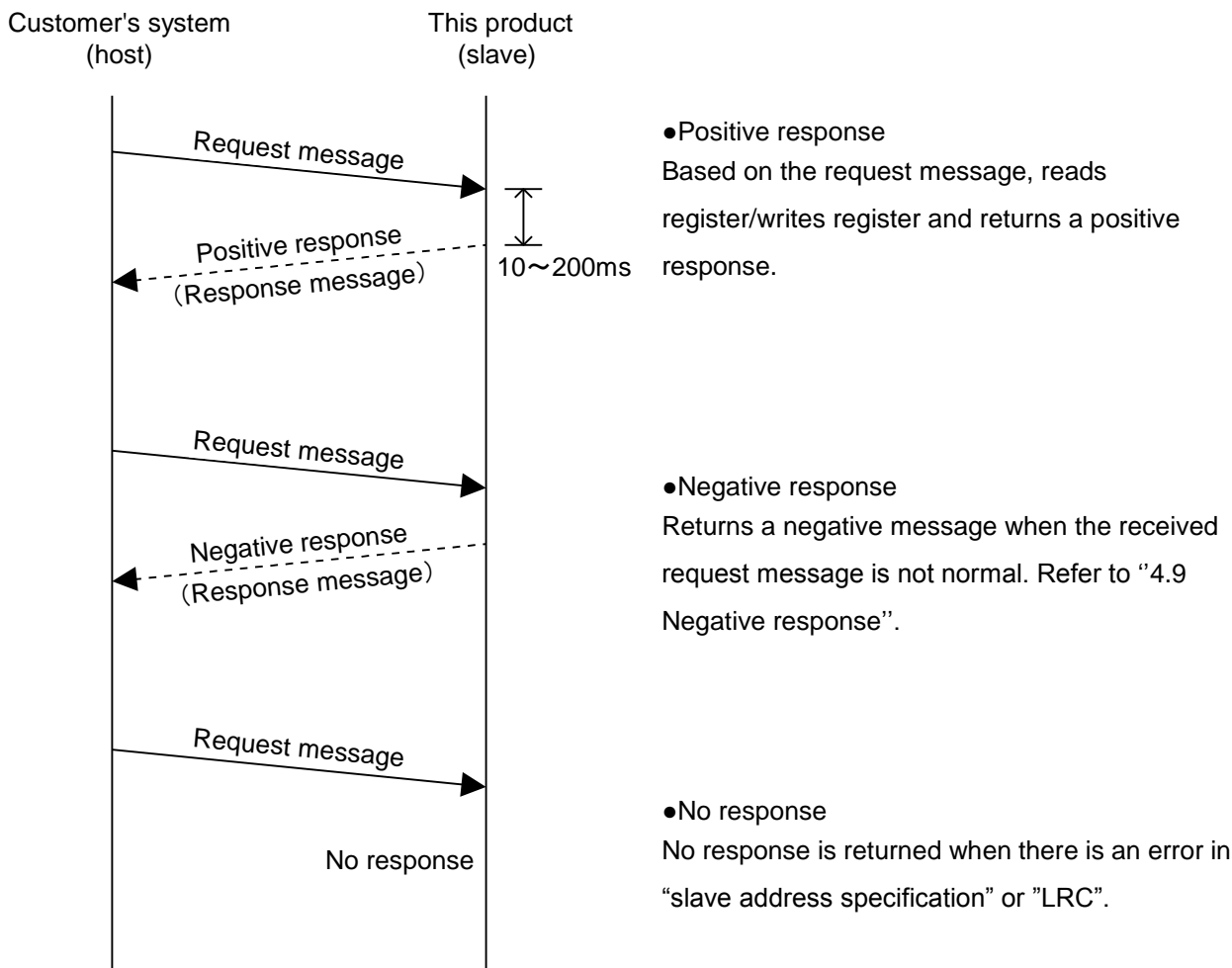

4.5 Message configuration

4.5.1 Message format

The message configuration is shown below. This product communicates in ASCII mode. ASCII mode is used from Start to End.

1)	2)	3)	4)	5)	6)						
Start	Slave Address		Function		Data		LRC		End		
[:]	XX	XX	XX	XX	XX	~	XX	XX	XX	[CR]	[LF]

1) Start

The start of the message. [:](3Ah)

2) Slave Address (1 to 99 3031h to 3939h)

This is a number to identify this product. "1" is the default setting. This can be changed by the operation display panel.

3) Function (Refer to "4.6 Function codes".)

Command is assigned.

4) Data

Depending on the function, the address and the number of the register, the value of reading/writing are assigned.

5) LRC

LRC method

Refer to "4.7 LRC".

6) END

The end of the message. [CR](0Dh) + [LF](0Ah)

A response message will not be returned unless the request includes [:] and [CR][LF]. This product clears all previously received code when [:] is received.

4.5.2 Message example

The example shows communication with the conditions below.

- Slave Address : No.1
- Read seven consecutive data from register 0000h.
(Read circulating fluid discharge temperature.)

■ Communication example

CAUTION

The communication example is expressed in hexadecimal value with []. The actual communication is performed in ASCII code. Refer to the request / response message in this section.

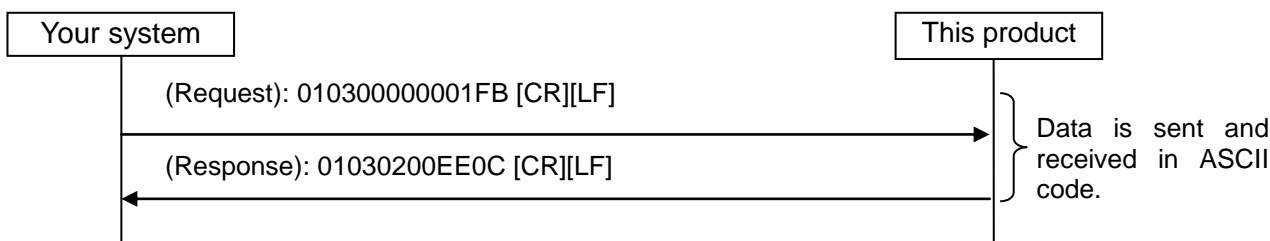

Request message		Response message	
Code	Contents	Code	Contents
01	Slave Address	01	Slave Address
03	Function	03	Function
0000	Head address of specified register	02	Quantity of bytes to read
0001	Quantity of register to read	00EE	Information of 0000h (circulating fluid discharge temperature: 23.8 °C)
FB	LRC	0C	LRC

■ Request message (Master to Slave)

Start	Slave Address		Function		Data	LRC		End	
3A	30	31	30	33		46	42	0D	0A

Read Address				Quantity to Read			
Hi		Lo		Hi		Lo	
30	30	30	30	30	30	30	31

■ Response message (Slave to Master)

Start	Slave Address		Function		Data	LRC		End	
3A	30	31	30	33		30	43	0D	0A

Byte Count		Read Data1			
		Hi		Lo	
30	32	30	30	45	45

4.6 Function codes

Table 4.6-1 shows function codes to read or write register.

Table 4.6-1 Function codes

NO	Code	Name	Function
1	03(03h)	Read holding registers	Reading multiple registers
2	06(06h)	Preset single register	Writing registers*1
3	16(10h)	Preset multiple registers	Writing multiple registers
4	23(17h)	Read/write 4x registers	Reading/writing multiple registers

*1 : Broadcast is not supported.

4.7 LRC

LRC checks the content of the message other than [:] of START and [CR][LF] of END. The sending side calculates and sets. The receiving side calculates based on the received message, and compares the calculation result with the received LRC. The received message is deleted if the calculation result and received LRC do not match.

Add up the byte number of the message consisting of 8 consecutive bits. The result except the carry (overflow) is converted to 2's complement.

■ Calculation example

LRC message for calculation	0106000B00FE
Calculation	○Addition $01h + 06h + 00h + 0Bh + 00h + FEh = 110h$ ○Object $110h \rightarrow 10h$ ○complement of 2 $10h \rightarrow EFh \rightarrow F0h$ LRC is F0h
Sending message	[:]0106000B00FEF0[CR][LF]

4.8 Explanation of function codes

4.8.1 Function code : 03 Reading multiple registers

Register data of assigned points from assigned address is read.

Request message <Normal> (Master to Slave)

Start	Slave Address	Function	Data	LRC	End
[:]	XX XX	[0] [3]		XX XX	[CR] [LF]

Read Address				Quantity to Read			
Hi		Lo		Hi		Lo	
XX	XX	XX	XX	XX	XX	XX	XX

Response message<Normal> (Slave to Master)

Start	Slave Address	Function	Data	LRC	End
[:]	XX XX	[0] [3]		XX XX	[CR] [LF]

Byte Count	Read Data 1				Read Data n			
	Hi		Lo		Hi		Lo	
XX XX	XX	XX	XX	XX	XX	XX	XX	XX

Communication example

○Slave Address: No.1

○Read seven consecutive data from register 0000h.

(Read circulating fluid discharge temperature, circulating fluid discharge pressure, status information, alarm information.)

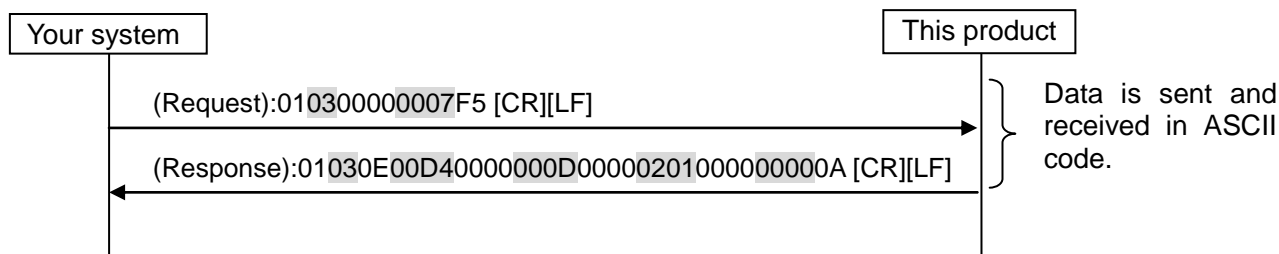

Request message		Response message	
Code	Contents	Code	Contents
01	Slave Address	01	Slave Address
03	Function	03	Function
0000	Head address of specified register	0E	Quantity of bytes to read
0007	Quantity of register to read	00D4	Information of 0000h (circulating fluid discharge temperature)
F5	LRC	0000	Information of 0001h (Reserved)
		000D	Information of 0002h (circulating fluid discharge pressure)
		0000	Information of 0003h (Electric resistivity/conductivity of the circulating fluid)
		0201	Information of 0004h (Status flag 1)
		0000	Information of 0005h (Alarm flag 1)
		0000	Information of 0006h (Alarm flag 2)
		0A	LRC

4.8.2 Function code : 06 Writing registers

Write data to assigned address.

■ Request message <Normal> (Master to Slave)

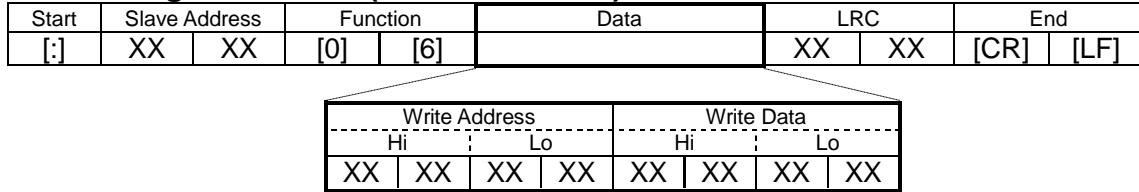

■ Response message <Normal> (Slave to Master)

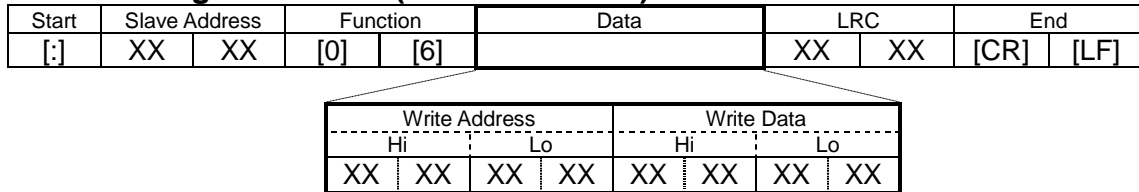

■ Communication example

○Slave Address: No 1
 ○Write data to register 000Ch
 (Commands to run)

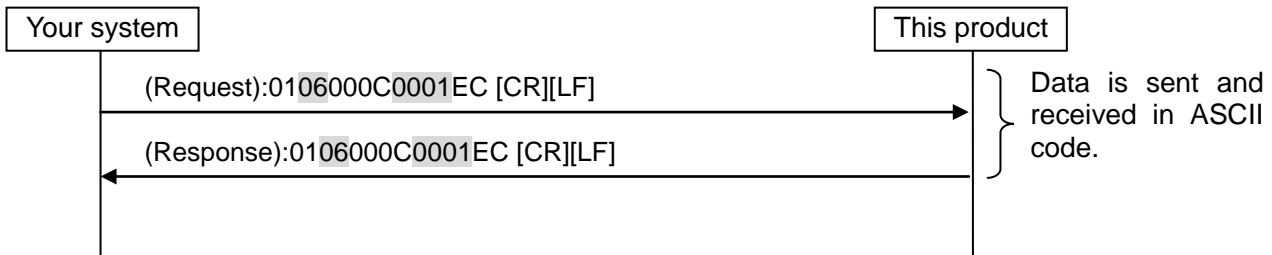

Request message		Response message	
Code	Contents	Code	Contents
01	Slave Address	01	Slave Address
06	Function	06	Function
000C	Address of specified register	000C	Address of register to write
0001	Information written to 000Ch (Stop flag)	0001	Information of register to write
EC	LRC	EC	LRC

4.8.3 Function code : 16 Writing multiple registers

Register content of assigned points of assigned address is written.

Request message <Normal> (Master to Slave)

Start	Slave Address		Function		Data	LRC		End	
[:]	XX	XX	[1]	[0]		XX	XX	[CR]	[LF]

Write Address				Quantity to Write			
Hi		Lo		Hi		Lo	
XX	XX	XX	XX	XX	XX	XX	XX

Byte Count		Write Data 1			
		Hi		Lo	
XX	XX	XX	XX	XX	XX

Write Data n			
Hi		Lo	
XX	XX	XX	XX

Response message <Normal> (Slave to Master)

Start	Slave Address		Function		Data	LRC		End	
[:]	XX	XX	[1]	[0]		XX	XX	[CR]	[LF]

Write Address				Quantity to Write			
Hi		Lo		Hi		Lo	
XX	XX	XX	XX	XX	XX	XX	XX

Communication example

○Slave Address: No 1

○Write two consecutive data from register 000Bh.

(Commands to change of circulating fluid set temperature <39.9°C > and run.)

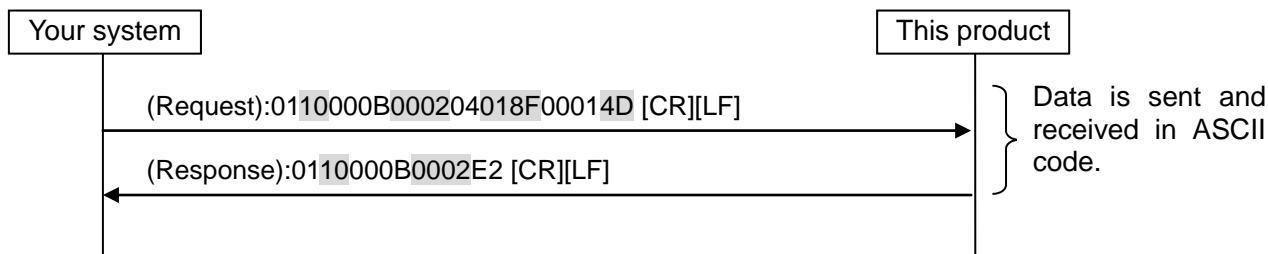

Request message		Response message	
Code	Contents	Code	Contents
01	Slave Address	01	Slave Address
10	Function	10	Function
000B	Head address of specified register	000B	Head address of register to write
0002	Quantity of register to write	0002	Quantity of register to write
04	Quantity of byte to read	E2	LRC
018F	Information written to 000Bh (Circulating fluid set temperature)		
0001	Information written to 000Ch (Stop flag)		
4D	LRC		

4.8.4 Function code : 23 Reading/writing multiple registers

Register content of assigned points of assigned address is read. Write the register data from the specified address with specified points simultaneously.

■ Request message <Normal> (Master to Slave)

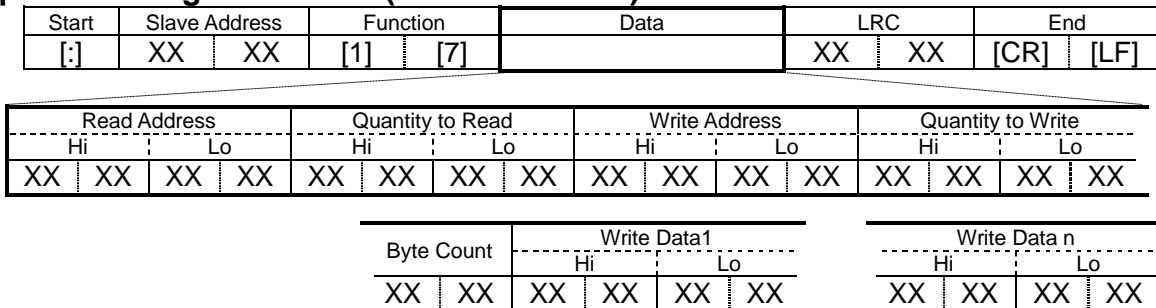

■ Response message <Normal> (Slave to Master)

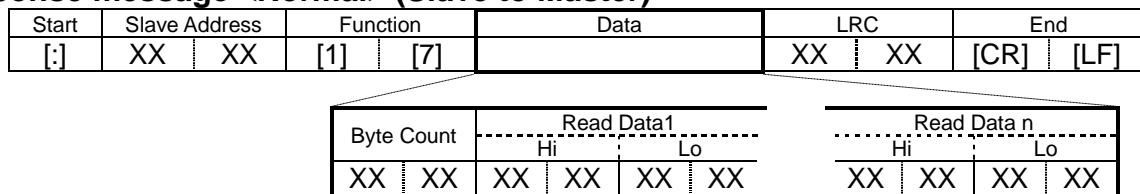

■ Communication example

○Slave Address: No 1

○Read three consecutive data from register 0004h, and write two consecutive data from register 000Bh.

(Command to change the circulating fluid set temperature to <15.5°C>, and read status and alarm information.)

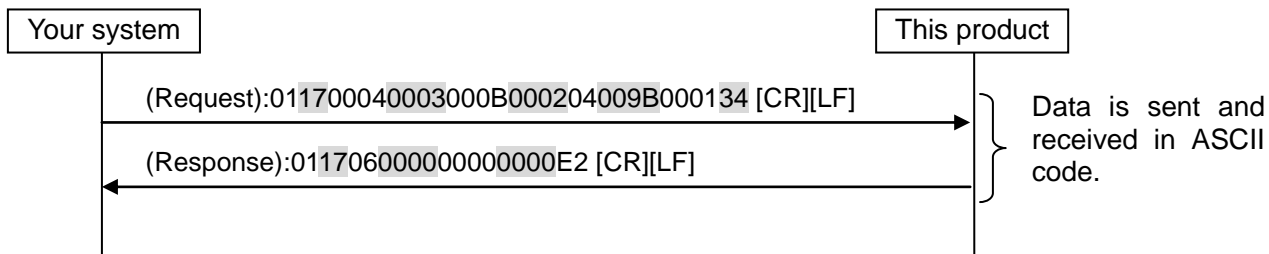

Request message		Response message	
Code	Contents	Code	Contents
01	Slave Address	01	Slave Address
17	Function	17	Function
0004	Head address of specified register	06	Quantity of byte to read
0003	Quantity of register to read	0000	Information of 0004h (Status flag 1)
000B	Head address of specified register	0000	Information of 0005h (Alarm flag 1)
0002	Quantity of register to write	0000	Information of 0006h (Alarm flag 2)
04	Quantity of byte to write	E2	LRC
009B	Information written to 000Bh (Circulating fluid set temperature)		
0001	Information written to 000Ch (Stop flag)		
34	LRC		

4.9 Negative response

A negative response is returned when the following request message is received.

- 1) When unspecified function code is used.
- 2) An address out of range is specified.
- 3) The data field is not normal.

■ Negative response message (Slave to Master)

Start	Slave Address		Function		Error Code		LRC		End	
	[:]	XX	XX	[0]	[3]	XX	XX	XX	XX	[CR]

1) Function

Assign the value consisting of the request function code (hexadecimal value) plus 80h in ASCII code.

2) Error Code

Assign error code below.

- 01 : Function code of a command is outside the standard
- 02 : The specified address of register is outside the range.
- 03 : Data field of a command is not normal.

■ Communication example

- Slave Address: No 1
- Read seven consecutive data from register 0100h which is out of range.

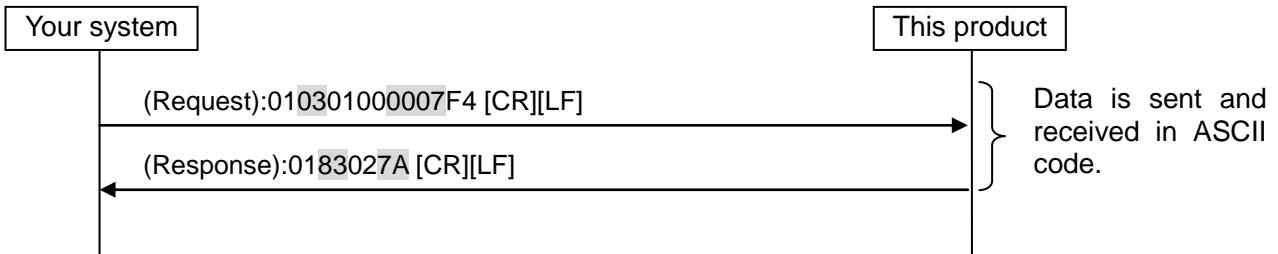

Request message		Response message	
Code	Contents	Code	Contents
01	Slave Address	01	Slave Address
03	Function	83	Function (03h+80h)
0100	Head address of register out of range	02	Error Code (Specified register address is out of range.)
0007	Quantity of register to read	7A	LRC
F4	LRC		

4.10 Register Map

Address	Bit Format																R/W
	15	14	13	12	11	10	9	8	7	6	5	4	3	2	1	0	
0000h	Circulating fluid discharge temperature -110.0 to 150.0°C = FBB4h to 5DCh (0.1°C /dig) -166.0 to 302.0°F = F984h to BCCh (0.1°F /dig)																R
0001h	Reserved																
0002h	Circulating fluid discharge pressure 0.00 to 3.00MPa = 0h to 12Ch (0.01MPa/dig) 0 to 435PSI = 0h to 1B3h (1PSI/dig)																
0003h	Electric resistivity/conductivity of the circulating fluid 0 to 4.5MΩ·cm = 0h to 2dh (0.1MΩ·cm /dig) 2.0 to 48.0μS/cm = 14h to 1E0h (0.1μS/cm /dig)																
0004h	Status flag 1																
0005h	Alarm flag 1																
0006h	Alarm flag 2																
0007h	Alarm flag 3																
0008h	Reserved																
0009h	Status flag 2																
000Ah	Reserved																
000Bh	Circulating fluid set temperature 5.0 to 40.0°C = 32h to 190h (0.1°C /dig) 41.0 to 104.0°F = 19Ah to 410h (0.1°F /dig)																R/W
000Ch	Reserved																
000Dh	Reserved																
000Eh	Reserved																
000Fh	Reserved																

*1 : Commands to run

4.10.1 Circulating fluid discharge temperature

Read the circulating fluid discharge temperature in the selected temperature unit (°C or °F). Read the circulating fluid discharge temperature which is displayed on the operation display panel PV. (Offset temperature is displayed if offset function is set).

4.10.2 Circulating fluid discharge pressure

Read the circulating fluid discharge pressure in the selected pressure unit (MPa or PSI).

4.10.3 Electric resistivity/conductivity of the circulating fluid

Electric resistivity/conductivity of the circulating fluid is informed. The value is 0 [MΩ·cm/dig] / 0 [μS/cm/dig] when the optional [Electric resistivity/conductivity sensor] is invalid.

4.10.4 Status flag

The status of the product is read by the following assignment.

Status flag 1

Name	Status flag 1															
Bit	15	14	13	12	11	10	9	8	7	6	5	4	3	2	1	0

Bit	Name	Explanation
0	Run flag	Run status (Include the independent operation of the pump) 0= Stop 1= Run
1	Operation stop alarm flag	Operation stop alarm given off status 0= Not occurred 1= Operation stop alarm given off
2	Operation continued alarm flag	Operation continued alarm given off status 0= Not occurred 1= Operation continued alarm given off
3	Unused	
4	Press Unit flag	Pressure unit set status 0= MPa 1= PSI
5	Remote status flag	Remote status 0= Other than SERIAL mode 1= SERIAL mode
6	Unused	
7	Unused	
8	Unused	
9	Completion of preparation (TEMP READY) flag	Completion of preparation (TEMP READY) status 0= Condition isn't formed 1= Condition is formed
10	Temperature unit flag	Temperature unit set status 0= Centigrade (°C) 1= Fahrenheit (°F)
11	Run timer flag	Run timer set status 0= Not set 1= Set
12	Stop timer flag	Stop timer set status 0= Not set 1= Set
13	Reset after power failure flag	Reset after power failure set status 0= Not set 1= Set
14	Anti-freezing flag	Anti-freezing set status 0= Not set 1= Set
15	Automatic fluid filling flag	Automatic fluid filling condition 0= Stop 1= Fluid * The signal of the product without an option [Automatic filling] also changes.

Status flag 2

Name	Status flag 2															
Bit	15	14	13	12	11	10	9	8	7	6	5	4	3	2	1	0

Bit	Name	Explanation
0	Electric resistivity/conductivity setting flag	Electric resistivity/conductivity setting status 0= Not set 1= Electric resistivity is set 2= Electric conductivity is set
1		
2~15	Unused	

4.10.5 Alarm flag

Each type of alarm which occurs in the product is read with the following assignment.

Name	Alarm flag 1															
Bit	15	14	13	12	11	10	9	8	7	6	5	4	3	2	1	0
Name	Alarm flag 2															
Bit	15	14	13	12	11	10	9	8	7	6	5	4	3	2	1	0
Name	Alarm flag 3															
Bit	15	14	13	12	11	10	9	8	7	6	5	4	3	2	1	0

Bit	Name	Explanation	
Alarm flag 1	0	Low level in tank	Alarm given off status 0= Not occurred 1= Occurred
	1	High circulating fluid discharge temp.	
	2	Circulating fluid discharge temp. rise	
	3	Circulating fluid discharge temp.	
	4	High circulating fluid return temp.	
	5	High circulating fluid discharge pressure	
	6	Abnormal pump operation	
	7	Circulating fluid discharge pressure rise	
	8	Circulating fluid discharge pressure drop	
	9	High compressor intake temp.	
	10	Low compressor intake temp.	
	11	Low super heat temperature	
	12	High compressor discharge pressure	
	13	Unused	
	14	Refrigerant circuit pressure (high pressure side) drop	
15	Refrigerant circuit pressure (low pressure side) rise		
Alarm flag 2	0	Refrigerant circuit pressure (low pressure side) drop	
	1	Compressor overload	
	2	Communication error	
	3	Memory error	
	4	DC line fuse cut	
	5	Circulating fluid discharge temp. sensor failure	
	6	Circulating fluid return temp. sensor failure	
	7	Compressor intake temp. sensor failure	
	8	Circulating fluid discharge pressure sensor failure	
	9	Compressor discharge pressure sensor failure	
	10	Compressor intake pressure sensor failure	
	11	Maintenance of pump	
	12	Maintenance of fan motor	
	13	Maintenance of compressor	
	14	Contact input 1 signal detection alarm	
15	Contact input 2 signal detection alarm		

Bit	Name	Explanation
Alarm flag 3	0	Water leakage
	1	Electric resistivity/conductivity level rise
	2	Electric resistivity/conductivity level drop
	3	Electric resistivity/conductivity sensor error
	4	Unused
	5	Unused
	6	Unused
	7	Unused
	8	Unused
	9	Unused
	10	Unused
	11	Unused
	12	Unused
	13	Unused
	14	Unused
	15	Unused

Alarm given off status
 0= Not occurred 1= Occurred

- The current alarm flag bit assignment will be changed in the future due to the addition of optional functions.
- Unused bit is fixed to 0.

4.10.6 Circulating fluid set temperature

The circulating fluid set temperature can be set by specifying the circulating fluid set temperature with the selected temperature unit (°C or °F) during SERIAL mode.

If the temperature exceeds the upper limit of the circulating fluid set temperature range, the circulating fluid set temperature is changed to the upper limit value. If it is lower than the lower limit, the circulating fluid set temperature is changed to the lower limit value.

4.10.7 Operation Start Command

The operation can be controlled by sending the operation start command during SERIAL mode.

0=Run stop 1=Run start

Chapter 5 Simple communication protocol function

Data can be read / written by this communication protocol. This protocol complies with SMC thermo-cooler HRG, HRGC series.

This communication has the following features.

- Sets and reads the circulating fluid set temperature.
- Reads the circulating fluid discharge temperature.

5.1 Precautions for communication

5.1.1 Precautions after wiring and before communication

○ Check or set each communication setting by the operation display panel.

• The communication specification shall be the customer's communication standard.

- The serial protocol shall be the simple communication protocol 1 or 2.

Simple communication protocol 1 : Operation display panel controls the start and stop of the product.

Simple communication protocol 2 : Controls the start and stop of the product remotely.

Refer to chapter 2.4 for remote setting when this protocol is selected.

- The communication mode shall be the SERIAL mode.

Other modes can perform reading, but only SERIAL mode can perform writing of values.

○ Check or set the communication parameters using the operation display panel.

Check or set the communication speed, the presence of BCC, data length, parity check, stop bit length, response delay time, and communication range (RO or RW) to synchronize the product with the host computer (master) prepared by the customer.

○ Check the slave address of this product.

No response is returned when a request message is sent from a slave address other than those set in the product.

5.1.2 Precautions for communicating

○Check the data digit number and the decimal point location when requesting to write the set value.

○Allow a suitable interval between requests.

To send request messages in series, wait for 100msec. or longer after receiving a response message from the product before sending the next message.

○No response is returned for a request message of a command which is not supported by the product.

○Retry (resend request message).

The response may not be returned due to noise. If no message is returned after 1sec. of sending a request message, resend the request message.

○If necessary send a read request message to check if it was written correctly.

Message to notify the completion of the process is returned when the action for the written request message is completed.

5.1.3 Precautions after the completion of the communication

○Send the data storage request (STR) if necessary.

Data which is set by communication is stored in RAM. Set values stored in RAM are deleted when the power supplied to the product is cut. When the power is supplied again, operation starts with the values set before communication (values stored in FRAM of the product).

Store the values set by communication in FRAM (rewrite FRAM) by sending a data storage request message (STR) before cutting the power supply to the product.

Please check how many times it is possible to write to FRAM, and avoid unnecessary rewriting of the data during communication

5.2 Communication specification

Table 5.2-1 Communication specification of simple communication protocol

Item	Specification
Standard	Select from EIA RS-485/RS-232C
Communication speed	Select from 1200bps/2400bps/4800bps/9600bps/19200bps
Data·bit length	Select from 7bit/8bit
Stop·bit length	Select from 1bit、2bit
Parity	Select from without parity ,odd number ,even number
Letter code	ASCII mode
Slave address set range	Select from 1 to 99
Response delay time setting	Select from 0 to 250[msec]
Communication range	RO(Can read data only), Select from RW(can read and write data)
BCC	Select from with BCC , without BCC
Error check	EXOR algorithm of all data from STX to ETX is read only when BCC is selected.

 : Default setting

5.3 Setting and checking

5.3.1 Setting and checking items

The table below explains the setting items of the simple communication protocol function and the initial values.

Table 5.3-1 Communication setting items

Display	Item	Contents	Default setting
[0.01]	Communication mode	Sets communication mode.	LOC
[0.02]	Serial protocol	Sets serial communication protocol.	MDBS
[0.03]	Communication specification	Sets standard of the serial communication.	485
[0.04]	RS-485 terminal	Sets of the terminal of RS-485.	OFF
[0.07]	Slave address (Simple communication protocol)	Sets slave address of simple communication protocol. [----] is displayed when the setting of serial protocol is not simple communication protocol.	1
[0.08]	Communication speed (Simple communication protocol)	Sets communication speed of simple communication protocol. [----] is displayed when the setting of serial protocol is not simple communication protocol.	9.6
[0.09]	BCC (Simple communication protocol)	Sets error detection code of communication of simple communication protocol. [----] is displayed when the setting of serial protocol is not simple communication protocol.	ON
[0.10]	Data length (Simple communication protocol)	Sets data length. [----] is displayed when the setting of serial protocol is not simple communication protocol.	8BIT
[0.11]	Parity check (Simple communication protocol)	Sets parity check. [----] is displayed when the setting of serial protocol is not simple communication protocol.	NON
[0.12]	Stop bit length (Simple communication protocol)	Sets bit length. [----] is displayed when the setting of serial protocol is not simple communication protocol.	2BIT
[0.13]	Response delay time (Simple communication protocol)	Sets time to delay the response message of simple communication protocol. [----] is displayed when the setting of serial protocol is not simple communication protocol.	0
[0.14]	Communication range (Simple communication protocol)	Sets communication range of simple communication protocol. [----] is displayed when the setting of serial protocol is not simple communication protocol.	RW

5.3.2 Setting and checking

Communication mode Setting and checking

1. Press and hold the [MENU] key for 2 sec.

Repeat pressing the key until the setting screen for communication mode [Co.01] appears on the digital display.

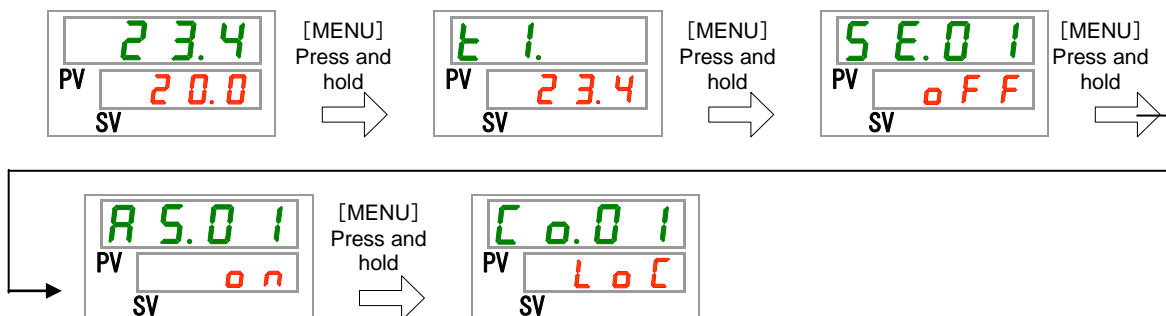

2. Select "SER" from the table below with the [▲] key, and confirm with "SEL".



Table 5.3-2 Set values

Set values	Explanation	Default setting
LoC	Sets LOCAL mode	○
dIo	Set s DIO mode	
SER	Sets SERIAL mode*1	

*1: If the serial protocol is "Simple communication protocol 2" and the contact input 1 is "external switch signal" or contact input 2 is "remote signal", "SERIAL mode" cannot be set.

Serial protocol Setting and checking

3. Press the [SEL] key once.

The set screen of serial protocol is displayed on the digital display.

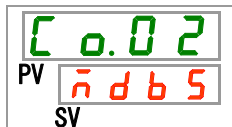

4. Select serial protocol from the table below with [▲] key or [▼] key, and confirm by pressing “SEL”.

Table 5.3-3 Set values

Set values	Explanation	Default setting
Modbus	MODBUS protocol	○
Pr01	Simple communication protocol	
Pr02	Simple communication protocol 2 ^{*2,*3}	

*2 : When the setting of the contact input 2 is “Remote signal”, “Simplified communication protocol 2” cannot be set.

*3: Refer to chapter 2.4 for remote setting when the communication mode is SERIAL and the simple communication protocol 2 is selected as the serial protocol.

Communication specification Setting and checking

5. Press the [SEL] key once.

The set screen of communication specification is displayed on the digital display.

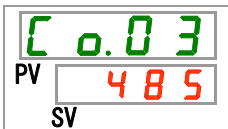

6. Select communication specification from the table below with [▲] key or [▼] key, and confirm by pressing “SEL”.

Table 5.3-4 Set values

Set values	Explanation	Default setting
232C	RS-232C Standard	
485	RS-485 Standard	○

RS-485 terminal Setting and checking

7. Press the [SEL] key once.

The set screen of RS-485 terminal is displayed on the digital display.

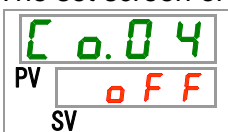

8. Select RS-485 terminal from the table below with [▲] key or [▼] key, and confirm by pressing “SEL”.

Table 5.3-5 Set values

Set values	Explanation	Default setting
OFF	Without terminal	○
ON	With terminal	

9. Press the [SEL] key 3 times.

The set screen of slave addresses (simple communication protocol) is displayed on the digital display.

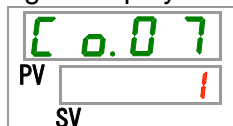

10. Select slave addresses (simple communication protocol) from the table below with [▲] key or [▼] key, and confirm by pressing “SEL”.

Table 5.3-6 Set values

Set values	Explanation	Default setting
----	Setting/checking are not available unless the serial protocol setting is simple communication protocol.	
! to 99	Sets of slave addresses for simple communication protocol. Set range is 1 to 99.	!

11. Press the [SEL] key once.

The set screen of communication speed (simple communication protocol) is displayed on the digital display.

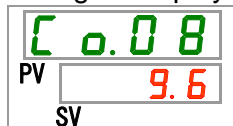

12. Select communication speed (simple communication protocol) from the table below with [▲] key or [▼] key, and confirm by pressing “SEL”.

Table 5.3-7 Set values

Set values	Explanation	Default setting
----	Setting/checking are not available unless the serial protocol setting is simple communication protocol.	
1.2	1200bps	
2.4	2400bps	
4.8	4800bps	
9.6	9600bps	○
19.2	19200bps	

13. Press the [SEL] key once.

The set screen of BCC (simple communication protocol) is displayed on the digital display.

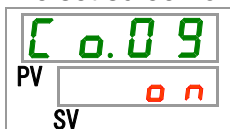

14. Select BCC (simple communication protocol) from the table below with [▲] key or [▼] key, and confirm by pressing “SEL”.

Table 5.3-8 Set values

Set values	Explanation	Default setting
----	Setting/checking are not available unless the serial protocol setting is simple communication protocol.	
o F F	Without BCC	
o n	With BCC	○

Data length (simple communication protocol) Setting and checking

15. Press the [SEL] key once.

The set screen of data length (simple communication protocol) is displayed on the digital display.

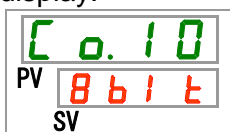

16. Select data length (simple communication protocol) from the table below with [▲] key or [▼] key, and confirm by pressing “SEL”.

Table 5.3-9 Set values

Set values	Explanation	Default setting
----	Setting/checking are not available unless the serial protocol setting is simple communication protocol.	
7 b i t	7 bit	
8 b i t	8 bit	○

Parity check (simple communication protocol) Setting and checking

17. Press the [SEL] key once.

The set screen of parity check (simple communication protocol) is displayed on the digital display.

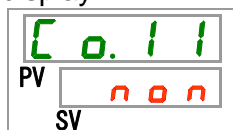

18. Select parity check (simple communication protocol) from the table below with [▲] key or [▼] key, and confirm by pressing “SEL”.

Table 5.3-10 Set values

Set values	Explanation	Default setting
----	Setting/checking are not available unless the serial protocol setting is simple communication protocol.	
non	None	○
odd	Odd number	
Even	Even number	

Stop bit (simple communication protocol) Setting and checking

19. Press the [SEL] key once.

The set screen of stop bit (simple Communication protocol) is displayed on the digital display.

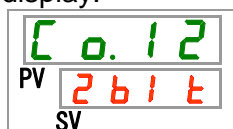

20. Select stop bit (simple communication protocol) from the table below with [▲] key or [▼] key, and confirm by pressing “SEL”.

Table 5.3-11 Set values

Set values	Explanation	Default setting
----	Setting/checking are not available unless the serial protocol setting is simple communication protocol.	
1bit	1 bit	
2bit	2 bit	○

Response delay time (simple communication protocol) Setting and checking

21. Press the [SEL] key once.

The set screen of response delay time (simple communication protocol) is displayed on the digital display.

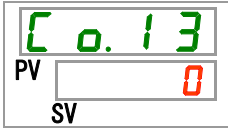

22. Select response delay time (simple communication protocol) from the table below with [▲] key or [▼] key, and confirm by pressing “SEL”.

Table 5.3-12 Set values

Set values	Explanation	Default setting
----	Setting/checking are not available unless the serial protocol setting is simple communication protocol.	
0 to 250	Sets of response delay time Set range is 0 to 250m sec.	0

Communication range (simple communication protocol) Setting and checking

23. Press the [SEL] key once.

The set screen of communication range (simple communication protocol) is displayed on the digital display.

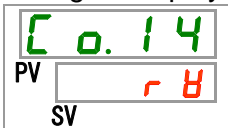

24. Select communication range (simple communication protocol) from the table below with [▲] key or [▼] key, and confirm by pressing “SEL”.

Table 5.3-13 Set values

Set values	Explanation	Default setting
----	Setting/checking are not available unless the serial protocol setting is simple communication protocol.	
r 0	Only reading is available	
r 0	Reading and writing are available	○

5.4 Communication sequence

Starts with a request message from the customer's system (host), and finishes with a response message from the product (slave). This product operates as a slave. It does not send any requests.

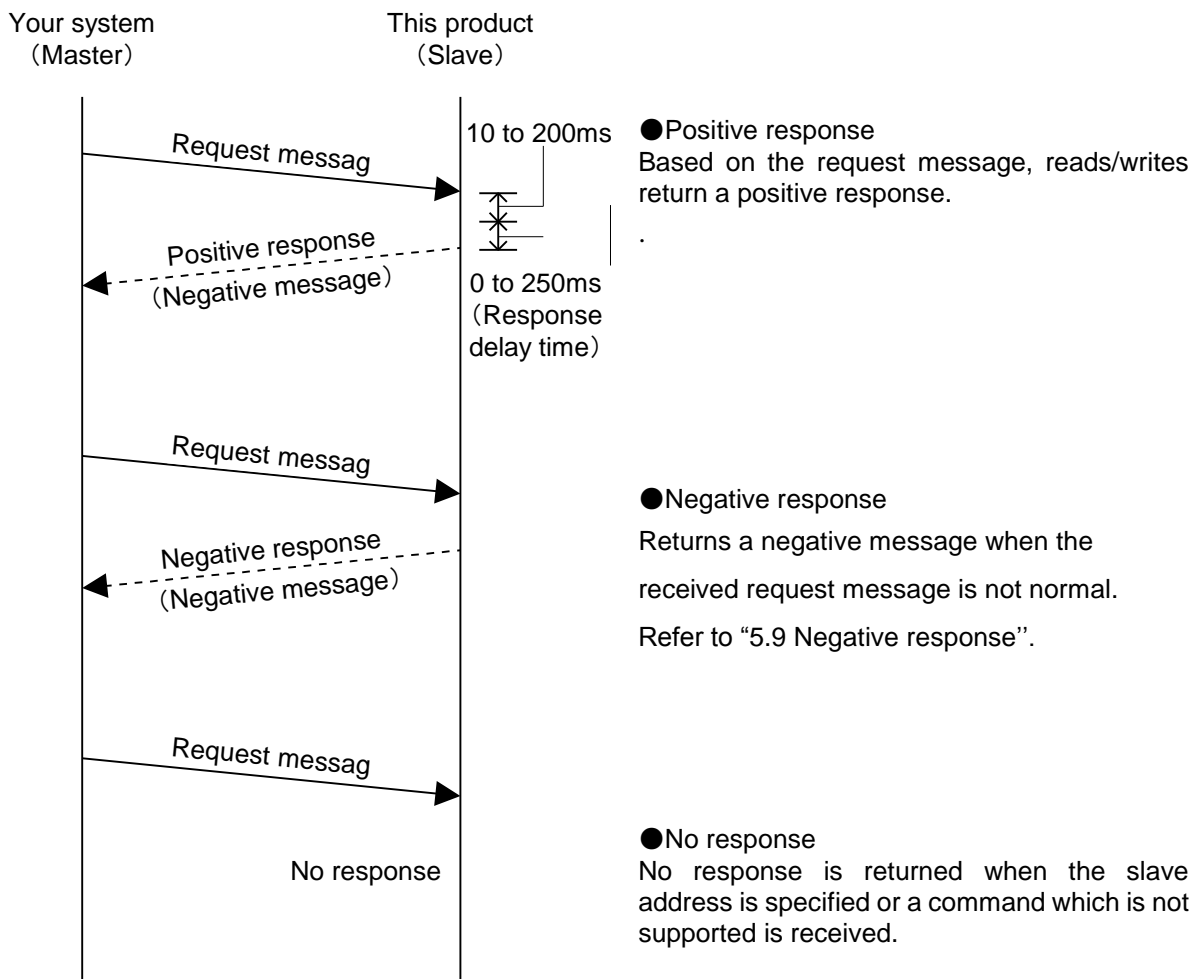

5.5 Message configuration

The message configuration is shown in the following. The explanation of data in message is shown in the Table 5.5-1.

This product communicates in ASCII mode. ASCII mode is used from STX to ETX. Hexadecimal value is used for BCC.

5.5.1 Message format

1) Request message format

1-1) Request message (Request to read)

STX	Slave Address		Request	Command			ETX	BCC
[STX]	XX	XX	[R]	XX	XX	XX	[ETX]	XX

1-2) Request message (Request to write)

STX	Slave Address		Request	Command			Writing data					ETX	BCC
[STX]	XX	XX	[W]	XX	XX	XX	XX	XX	XX	XX	XX	[ETX]	XX

1-3) Request message (Request to store the data)

STX	Slave Address		Request	Command			ETX	BCC
[STX]	XX	XX	[W]	XX	XX	XX	[ETX]	XX

2) Response message format

2-1) Response message (Normal response to request to write)

STX	Slave Address		ACK	Command			Reading data					ETX	BCC
[STX]	XX	XX	[ACK]	XX	XX	XX	XX	XX	XX	XX	XX	[ETX]	XX

2-2) Response message (Normal response to request to write or store the data)

STX	Slave Address		ACK	ETX	BCC
[STX]	XX	XX	[ACK]	[ETX]	XX

2-3) Response message (Response when a receiving error occurred)

STX	Slave Address		NAK	ETX	BCC	
[STX]	XX	XX	[NAK]	XX	[ETX]	XX

Exception code

Response is not returned unless STX and ETX (BCC) are included in the request. This product clears all previously received code when STX is received.

Table 5.5-1 Format data

NO	Item	Explanation																				
1	STX(02h)	Start text The code to specify the head of the message. Added to the head of the characters to be sent.																				
2	ETX(03h)	End text The code to specify the end of the message. Added to the end of the characters to be sent. Other than BCC.																				
3	Slave Address	Slave address which is set to each product. Can be changed by setting. The address to identify the device.																				
4	Request	Request identifier. R (reading) or W (writing)																				
5	Command	Command to reading or writing.																				
6	Writing Reading	To request writing, write the data in this area to the object data. To request reading, set the object data in this area.																				
7	BCC	EXOR algorithm of all characters from STX to ETX is read with the check code for error detection. This code (BCC) is not included in "response" if BCC check is not selected when setting the communication.																				
8	ACK(06h)	Acknowledge code. This is included in the response from the product when there is no error in the received request.																				
9	NAK(15h)	Negative acknowledge code. This is included in the response from the product when there is an error in the received request.																				
10	Exception code	<p>Error content is included in the response when there is an error in the received request. Refer to the table below for exception codes.</p> <table border="1"> <thead> <tr> <th>Exception code</th> <th>Exception</th> </tr> </thead> <tbody> <tr> <td>0</td> <td>Equipment malfunction Memory error</td> </tr> <tr> <td>1</td> <td>Out of set range Value data is out of "set range specified independently by set parameter"</td> </tr> <tr> <td>2</td> <td>Setting not allowed. Changing of requested communication parameter is prohibited. Or communication parameter to read does not exist. Writing of the communication mode is requested while the communication mode change is set to RO (read only) Writing to PV (measured value) is requested.</td> </tr> <tr> <td>3</td> <td>Abnormal code ASCII code other than numerical data is requested (specified) to the location for numerical data. ASCII code other than "0" or "-" is requested (specified) to the location for symbol.</td> </tr> <tr> <td>4</td> <td>Format error</td> </tr> <tr> <td>5</td> <td>BCC error</td> </tr> <tr> <td>6</td> <td>Overrun error</td> </tr> <tr> <td>7</td> <td>Fleming error</td> </tr> <tr> <td>8</td> <td>Parity error</td> </tr> </tbody> </table> <p>*1 : Exception code "0" is included in the response regardless of the presence of the request error because memory error is present. *2 : The exception with the highest number is included in the response when two or more errors have occurred.</p>	Exception code	Exception	0	Equipment malfunction Memory error	1	Out of set range Value data is out of "set range specified independently by set parameter"	2	Setting not allowed. Changing of requested communication parameter is prohibited. Or communication parameter to read does not exist. Writing of the communication mode is requested while the communication mode change is set to RO (read only) Writing to PV (measured value) is requested.	3	Abnormal code ASCII code other than numerical data is requested (specified) to the location for numerical data. ASCII code other than "0" or "-" is requested (specified) to the location for symbol.	4	Format error	5	BCC error	6	Overrun error	7	Fleming error	8	Parity error
Exception code	Exception																					
0	Equipment malfunction Memory error																					
1	Out of set range Value data is out of "set range specified independently by set parameter"																					
2	Setting not allowed. Changing of requested communication parameter is prohibited. Or communication parameter to read does not exist. Writing of the communication mode is requested while the communication mode change is set to RO (read only) Writing to PV (measured value) is requested.																					
3	Abnormal code ASCII code other than numerical data is requested (specified) to the location for numerical data. ASCII code other than "0" or "-" is requested (specified) to the location for symbol.																					
4	Format error																					
5	BCC error																					
6	Overrun error																					
7	Fleming error																					
8	Parity error																					

5.5.2 Message example

The example shows communication with the conditions below.

- Slave Address : No.1
- Read seven consecutive data from register 0000h.
 (Read circulating fluid discharge temperature.)

■ Communication example

CAUTION

The communication example is expressed in hexadecimal value with []. The actual communication is performed with ASCII code. Refer to the request / response message in this section.

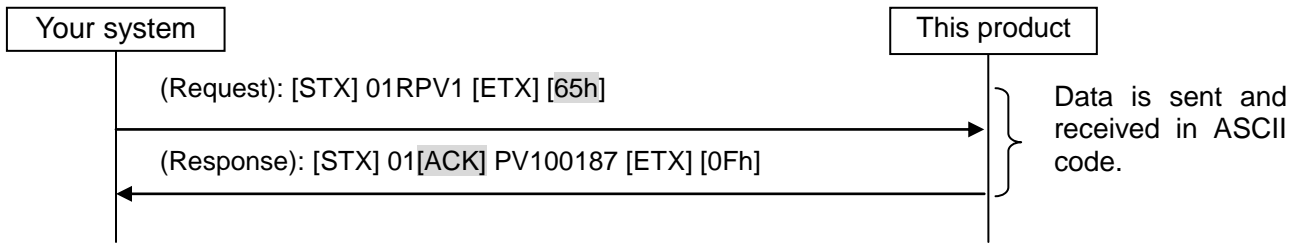

Request message		Response message	
Code	Contents	Code	Contents
01	Slave Address	01	Slave Address
R	Request message to read	[ACK]	Normal response message
PV1	Circulating fluid discharge temperature	PV1	Circulating fluid discharge temperature
[65h]	BCC value	00187	Read information
		[0Fh]	BCC value

■ Request message (Master to Slave)

STX	Slave Address		Request	Command			ETX	BCC
02	30	31	52	50	56	31	03	65

■ Response message (Slave to Master)

STX	Slave Address		ACK	Command			Reading data					ETX	BCC
02	30	31	06	50	56	31	30	30	31	38	37	03	0F

5.6 BCC

EXOR algorithm of all characters from STX to ETX is read with the check code for error detection.

This BCC is not included in "response" if BCC check is not selected when setting the communication.

Displayed in one digit of ASCII code in the message frame.

■ Calculation example

- Message for BCC

[STX] 01RPV1 [ETX]

- Calculation

ASCII	HEX
[STX]	02
'0'	30
'1'	31
'R'	52
'P'	50
'V'	56
'1'	31
[ETX]	03
'e'	65

←Code for EXOR from STX to ETX is BCC.

- Sending message

[STX] 01RPV1 [ETX] e

5.7 Command

Table 5.7-1 shows the commands which are supported by the product.

No response is returned for a request message of a command which is not in

Table 5.7-1.

Table 5.7-1 Command list

NO	Command	Name	R/W	Explanation
1	PV1	Circulating fluid discharge temperature	R	Read the circulating fluid discharge temperature in the temperature unit of the product. The circulating fluid discharge temperature (offset temperature if offset setting is selected) which is displayed on the operation display panel PV part. e.g. In case of 19.8°C 00198
2	SV1	Circulating fluid set temperature	R/W	Write/read the circulating fluid set temperature in the temperature unit of the product. Writing is available only in serial mode. e.g. In case of 35.8°C 00358
3	LOC	Key-lock setting	R/W	Write and read the key-lock setting. 00000 : Unlocked 00001 : All locked 00002 : Setting mode value is locked 00003 : Key lock other than for set temp. Key-lock setting of this product just receives the command. This command does not actually lock the keys. This function is to make this product interchangeable with the communication specifications of SMC's HRG/HRGC series thermo coolers. When not using this product as a replacement for HRG/HRGC, this function is not needed.
4	STR	Store the data	W	Store the data to the product (Write to FRAM)

5.8 Command explanation

5.8.1 Command:PV1 Circulating fluid discharge temperature

Read the circulating fluid discharge temperature in the selected temperature unit (°C or °F). The circulating fluid discharge temperature (offset temperature if offset setting is selected) which is displayed on the operation display panel PV part.

■ Request message <Normal> (Master to Slave)

STX	Slave Address		Request	Command			ETX	BCC
[STX]	XX	XX	[R]	[P]	[V]	[1]	[ETX]	XX

■ Response message <Normal> (Slave to Master)

STX	Slave Address		ACK	Command			Reading data					ETX	BCC
[STX]	XX	XX	[ACK]	[P]	[V]	[1]	XX	XX	XX	XX	XX	[ETX]	XX

■ Communication example

- Slave Address : No 1
- BCC selection

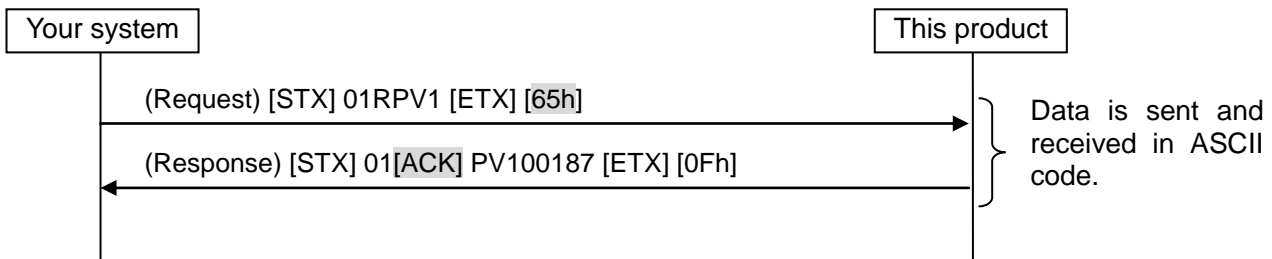

Request message		Response message	
Code	Contents	Code	Contents
01	Slave Address	01	Slave Address
R	Request message to read	[ACK]	Normal response message
PV1	Circulating fluid discharge temperature	PV1	Circulating fluid discharge temperature
[65h]	BCC value	00187	Read information (18.7°C)
		[0Fh]	BCC value

5.8.2 Command:SV1 Circulating fluid set temperature (R)

Read the circulating fluid set temperature in the selected temperature unit (°C or °F).

■ Request message <Normal> (Master to Slave)

STX	Slave Address		Request	Command			ETX	BCC
[STX]	XX	XX	[R]	[S]	[V]	[1]	[ETX]	XX

■ Response message <Normal> (Slave to Master)

STX	Slave Address		ACK	Command			Reading data					ETX	BCC
[STX]	XX	XX	[ACK]	[S]	[V]	[1]	XX	XX	XX	XX	XX	[ETX]	XX

■ Communication example

- Slave Address : No 1
- BCC selection

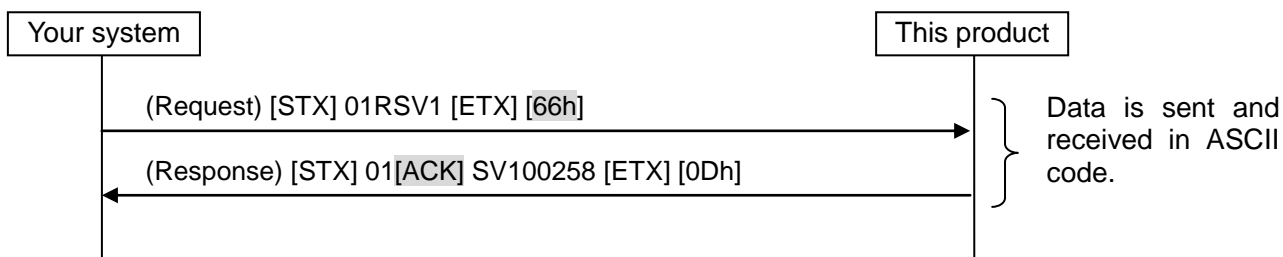

Request message		Response message	
Code	Contents	Code	Contents
01	Slave Address	01	Slave Address
R	Request message to read	[ACK]	Normal response message
SV1	Circulating fluid set temperature	SV1	Circulating fluid set temperature
[66h]	BCC value	00258	Read information (25.8°C)
		[0Dh]	BCC value

5.8.3 Command:SV1 Circulating fluid set temperature (W)

Read the circulating fluid set temperature in the selected temperature unit (°C or °F).

■ Request message <Normal> (Master to Slave)

STX	Slave Address		Request	Command			Writing data					ETX	BCC
[STX]	XX	XX	[W]	[S]	[V]	[1]	XX	XX	XX	XX	XX	[ETX]	XX

■ Response message <Normal> (Slave to Master)

STX	Slave Address		ACK	ETX	BCC
[STX]	XX	XX	[ACK]	[ETX]	XX

■ Communication example

- Slave Address : No 1
- BCC selection

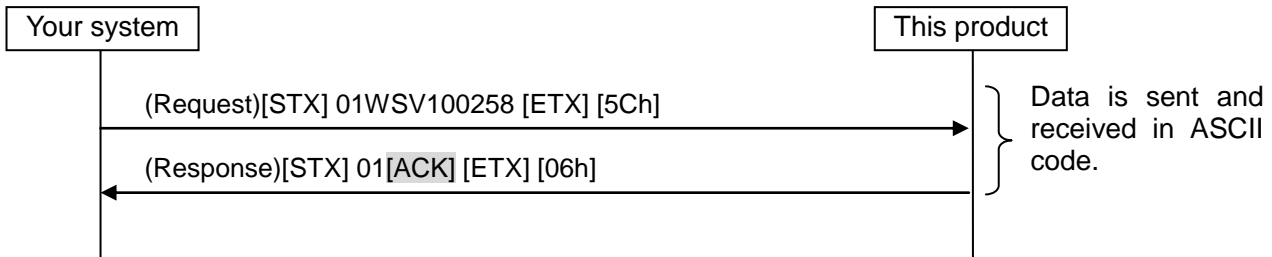

Request message		Response message	
Code	Contents	Code	Contents
01	Slave Address	01	Slave Address
W	Request message to write	[ACK]	Normal response message
SV1	Circulating fluid set temperature	[06h]	BCC value
00258	Write information (25.8 °C)		
[5Ch]	BCC value		

5.8.4 Command:LOC Key-lock setting (R)

Read the key-lock condition set in 5.8.5 "Command: LOC".

It is different from the key-lock information which is set by the operation display panel.

■ Request message <Normal> (Master to Slave)

STX	Slave Address	Request	Command			ETX	BCC
[STX]	XX XX	[R]	[L]	[O]	[C]	[ETX]	XX

■ Response message <Normal> (Slave to Master)

STX	Slave Address	ACK	Command			Reading data					ETX	BCC
[STX]	XX XX	[ACK]	[L]	[O]	[C]	XX	XX	XX	XX	XX	[ETX]	XX

■ Communication example

○Slave Address : No 1

○BCC selection

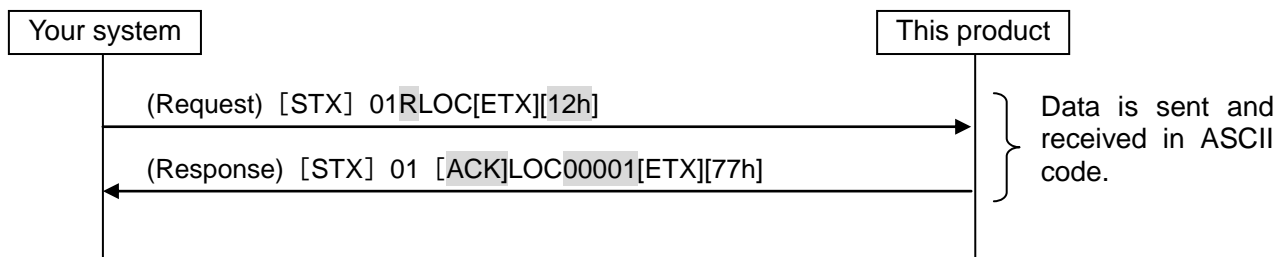

Request message		Response message	
Code	Contents	Code	Contents
01	Slave Address	01	Slave Address
R	Request message to read	[ACK]	Normal response message
LOC	Key-lock setting	LOC	Key-lock setting
[12h]	BCC value	00001	Read information (00001 : All locked)
		[77h]	BCC value

5.8.5 Command:LOC Key-lock setting (W)

Sets key-lock of this product. This setting is different from the key-lock information which is set by the operation display panel.

Key-lock setting of this product just receives the command. This command does not actually lock the keys.

This function is to make this product interchangeable with the communication specifications of SMC's HRG/HRGC series thermo coolers. When not using this product as a replacement for HRG/HRGC, this function is not needed.

■ **Request message <Normal> (Master to Slave)**

STX	Slave Address		Request	Command			Writing data					ETX	BCC
[STX]	XX	XX	[W]	[L]	[O]	[C]	XX	XX	XX	XX	XX	[ETX]	XX

■ **Response message <Normal> (Slave to Master)**

STX	Slave Address		ACK	ETX	BCC
[STX]	XX	XX	[ACK]	[ETX]	XX

■ **Communication example**

○Slave Address : No 1

○BCC selection

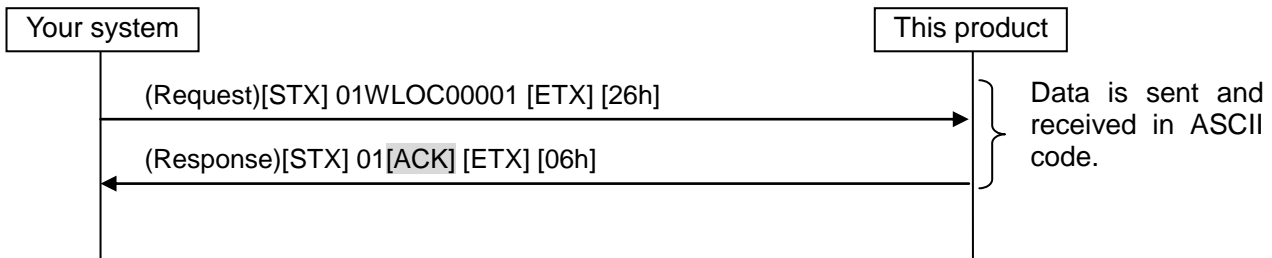

Request message		Response message	
Code	Contents	Code	Contents
01	Slave Address	01	Slave Address
W	Request message to write	[ACK]	Normal response message
LOC	Key-lock setting	[06h]	BCC value
00001	Read information (00001 : All locked)		
[26h]	BCC value		

5.8.6 Command:STR Saves data (W)

Store the circulating fluid set temperature set in 5.8.3 "Command:SV1 Circulating fluid set temperature". Key-lock set data which is set in 5.8.5 "Command:LOC Key-lock setting (W)" is not the object to store.

■ Request message <Normal> (Master to Slave)

STX	Slave Address		Request	Command			ETX	BCC
[STX]	XX	XX	[W]	[S]	[T]	[R]	[ETX]	XX

■ Response message <Normal> (Slave to Master)

STX	Slave Address		ACK	ETX	BCC
[STX]	XX	XX	[ACK]	[ETX]	XX

■ Communication example

○Slave Address : No 1

○BCC selection

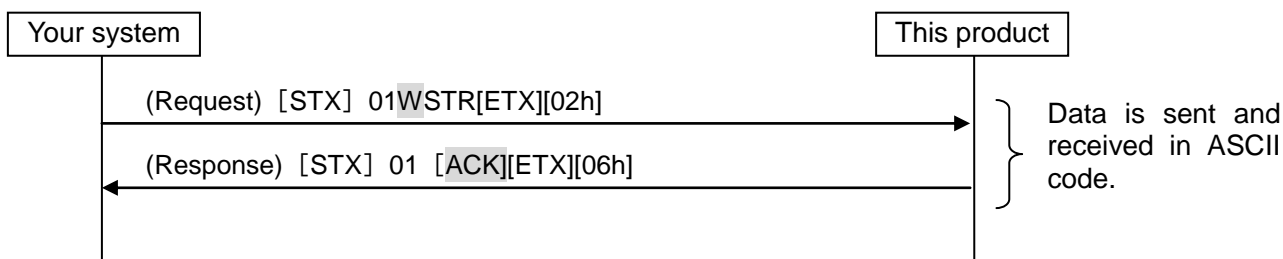

Request message		Response message	
Code	Contents	Code	Contents
01	Slave Address	01	Slave Address
W	Request message to write	[ACK]	Normal response message
STR	Saves data	[06h]	BCC value
[02h]	BCC value		

5.9 Negative response

If the request is not normal when receiving the request, or the request cannot be received due to the state of the product, a negative response is returned. Refer to the exception codes in Table 5.5-1 for exceptions.

■ Response message <Normal> (Slave to Master)

STX	Slave Address	NAK		ETX	BCC
[STX]	XX XX	[NAK]	XX	[ETX]	XX

Exception code

■ Communication example

○Slave Address : No 1

○Writing of the circulating fluid set temperature when the communication range setting is RO (read only).

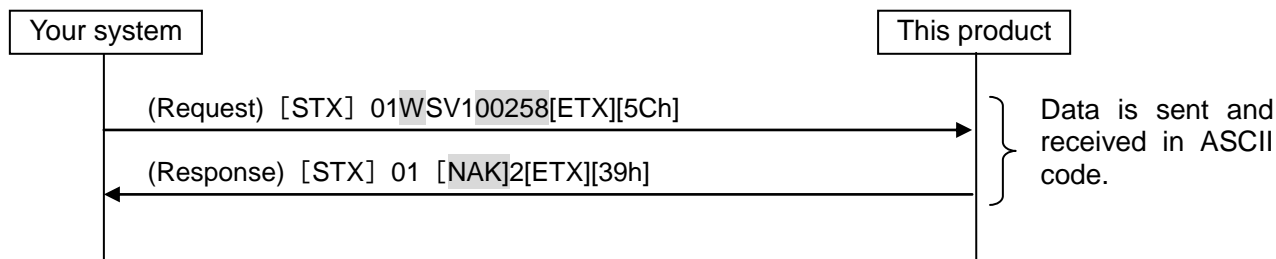

Request message		Response message	
Code	Contents	Code	Contents
01	Slave Address	01	Slave Address
W	Request message to write	[NAK]	Negative response message
SV1	Circulating fluid set temperature	2	Exception code for setting is prohibited
00258	Write information (15.1 °C)	[39h]	BCC value
[5Ch]	BCC value		

Chapter 6 Communication alarm function

Monitors whether the serial communication is sent/received properly between the product and the customer's device. This feature is only valid when the communication mode is set to SERIAL mode.

Abnormal signals or disconnection of the communication cable can be notified immediately by setting the alarm function to match the interval at which messages are sent from the customer device. When the communication is restored, the alarm is automatically reset.

Do not use this function when the customer device does not send messages regularly.

The default setting of this function is "off".

6.1 Communication alarm occurs

Fig 6.1-1 shows when an alarm occurs. Refer to 6.3 "Setting and checking" for the setting method.

- Changing of communication error
 - Operation continues when an alarm occurs.
- Time for monitoring the communication error
 - 180 sec

When the customer's device is sending messages every 60sec, if the communication cable is disconnected and no message is received for 180sec, the product generates AL19 communication error alarm to notify the error.

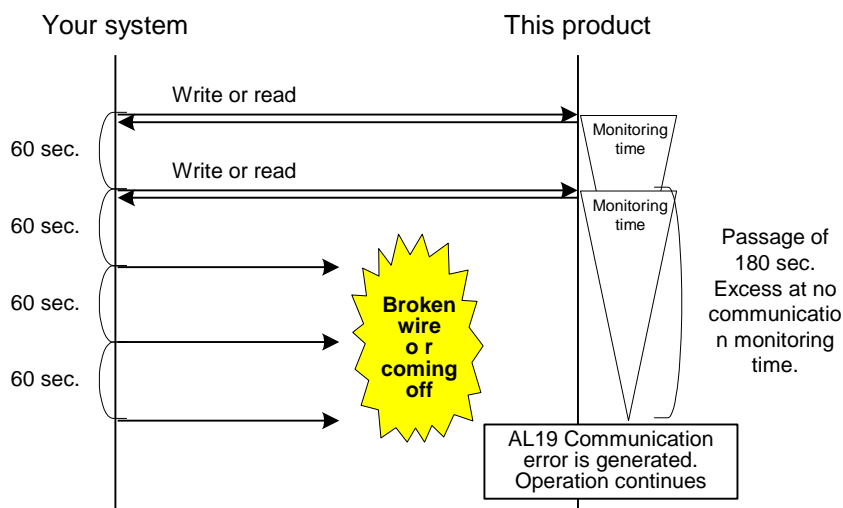

Fig 6.1-1 Communication alarm example

6.2 Communication alarm reset

When AL19 communication error has been generated, the alarm is automatically reset when the disconnection of the communication cable is fixed, and the message from the customer is received. If operation is set to stop when a communication alarm occurs, restart the operation if necessary.

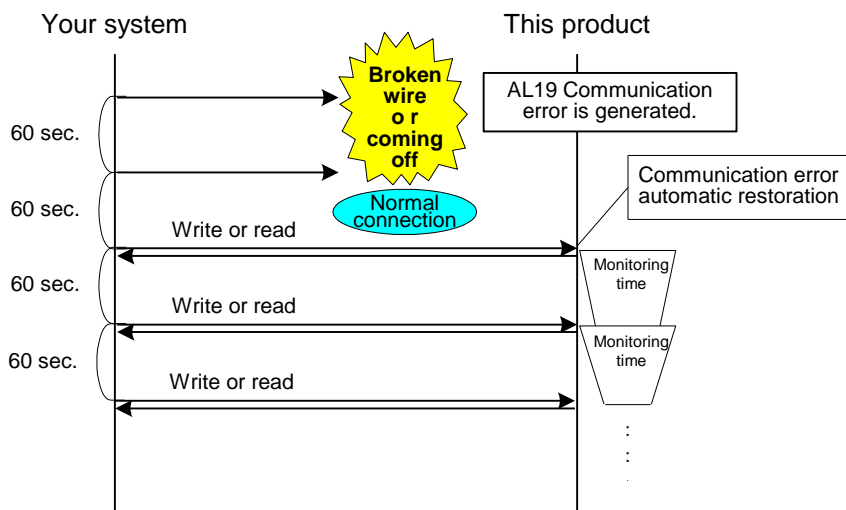

Fig 6.2-1 Communication alarm restoration example

6.3 Setting and checking

6.3.1 Setting and checking items

The table below explains the setting items of the communication alarm function and default values.

Table 6.3-1 Communication setting item

Display	Item	Contents	Default setting
A 5.11	Changing of communication error	Set the operation when the alarm No. AL19 "Communication error" is generated.	OFF
A 5.12	The monitoring time of communication error	Set the alarm monitoring time when the alarm No. AL19 "Communication error" is generated. Alarm signal is generated when the monitoring time is exceeded. Setting unit is 1 sec. [----] is displayed when the communication error setting is OFF.	30

6.3.2 Setting and checking

1. Press and hold the [MENU] key for 2 sec.

Repeat pressing the key until the setting screen for alarm buzzer sound [R5.01] appears on the digital display.

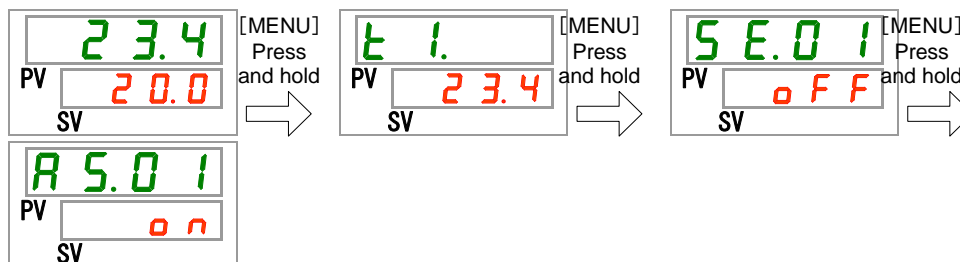

Changing of communication error Setting and checking

2. Display the screen of the communication error by pressing the [SEL] key 10 times.

The set screen of “changing of communication error” is displayed on the digital display.

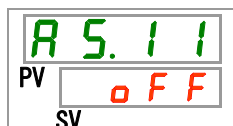

3. Select changing of operation when communication error from the table below with [▲] key or [▼] key, and confirm by pressing “SEL”.

Table 6.3-2 Set values

Set values	Explanation	Default setting
OFF	This alarm signal is not detected.	○
R.rUn	Operation continues when this communication error is generated.	
R.S.tP	Operation is stopped when this communication error is generated.	

The monitoring time of communication error Setting and checking

4. Press the [SEL] key once.

The set screen of the “monitoring time of communication error” is displayed on the digital display.

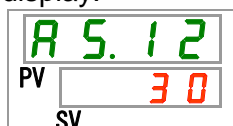

- 5.** Select the monitoring time of communication error from the table below with [▲] key or [▼] key, and confirm by pressing “SEL”.

Table 6.3-3 Set values

Set values	Explanation	Default setting
- - - -	Setting/checking are not available if the setting of the changing of communication error is OFF.	
<div style="text-align: center;"> 30 to 600 </div>	Sets monitoring time of communication error Setting range is 30 to 600 sec.	<div style="border: 1px solid black; padding: 2px; display: inline-block;">30</div>

Revision
Rev.N : Jul.2019

SMC Corporation

4-14-1, Sotokanda, Chiyoda-ku, Tokyo 101-0021 JAPAN

Tel: + 81 3 5207 8249 Fax: +81 3 5298 5362

URL <https://www.smcworld.com>

Note: Specifications are subject to change without prior notice and any obligation on the part of the manufacturer.
© 2019 SMC Corporation All Rights Reserved