



Operation Manual

PRODUCT NAME

IP Address Setting Tool
(Interactive Type)

MODEL / Series / Product Number

EX9-ZSW-IPC1

SMC Corporation

Table of Contents

1. License Agreement	2
2. Product Outline	3
3. Network Configuration Example	4
4. Setting the Computer's IP Address	5
5. IP address setting of the IP Address Setting Tool	5
6. Option Setting	7
7. Log monitor function	7
8. Export Function	8
9. Definitions and Terminology (Supplementary Explanation)	9

1. License Agreement

SMC Corporation (hereinafter referred to as "SMC") hereby grants the user (regardless of whether the user is a corporation or an individual) a license to use this software "SMC EtherNet/IP IP Address Setting Tool" (hereinafter referred to as "Software") according to this License agreement (hereinafter referred to as "Agreement") under the articles listed below.

Please check the content of this License Agreement, and only use it if you agree to all the terms and conditions herein. You cannot use this software, unless you agree with all the terms and conditions of this Licence Agreement.

Article 1 (Grant of license)

1. This Software is intended for use with the respective SMC EtherNet/IP Target product (henceforth referred to as "Target product") and it can only be used with Target products, in accordance with this licence agreement.
2. This software can only be installed on a PC for the sole purpose specified in the preceding paragraph.

Article 2 (Restrictions)

1. This software is not to be copied, except as specified in Article 1-2.
2. This software license is not to be transferred or loaned wholly or in part to a third party, either free of charge or for payment.
3. Modification, translation, adaptation or reverse engineering of this software is not permitted.
4. The user cannot use this software other than with the Target product.
5. This software cannot be used other than with the firmware which SMC provides.

Article 3 (Other notices)

1. Read the "Safety Instructions", "Precautions", "Specific Product Precautions" and "Specifications" described in the manual for the equipment when using any Target product supported by this Software.
2. This Software and the Target product are subject to change without prior notice.

Article 4 (Exemption of liability)

SMC cannot take any responsibility for any loss or damage incurred by the use of this Software or for any loss or damage that may occur as a consequence of the use of this software.

Article 5 (Termination)

1. SMC has the full authority to terminate this agreement without notice and without any compensation in the event that any terms and conditions have been breached.
2. This Software and any copies thereof must be destroyed when this Agreement is terminated.

Article 6 (Rights of this Software)

The copyright and any other rights of this Software are owned by SMC, and protected by Japanese copyright laws and international treaty provisions.

Article 7 (Governing law and jurisdiction)

1. This Agreement shall be governed by Japanese law.
2. Any dispute arising from this Agreement shall be submitted in the first instance to the exclusive jurisdiction of the Tokyo District Court or the Tokyo Summary Court primarily.

2. Product Outline

To connect an EtherNet/IP™ product to the EtherNet/IP™ network (hereafter referred to as "the network"), it is necessary to set the IP address. The IP Address Setting Tool is a tool for setting the IP address during DHCP mode and Remote control mode.

Operating systems for IP Address Setting Tool are as follows.

Windows®XP (32/64bit)
Windows®7 (32/64bit)
Windows®8 (32/64bit)
Windows®10 (32/64bit)

- *1) Install Microsoft .NET Framework 4 or later before use.
- *2) This tool might not operate correctly depending on the security setting of the PC. In that case, disable the security setting temporarily and try to use it again.

Applicable products are as follows.

EX260-SEN1/2/3/4
EX500-GEN2
EX600-SEN1/2/3/4
EX600-WEN1/2
JXC91/JXC92/JXC93

*: When the DHCP mode and the remote control mode are set

Make sure that all downloaded files are in the same folder as the EX9-ZSW-IPC1.exe file before use.

DhcpServerDll.dll
PacketDotNet.dll (*3)
SharpPcap.dll (*3)
Etc.

- *3) This is the open source software.
For details, please refer to "open_source_License" which is located in the folder in which all of the downloaded files are saved.

3. Network Configuration Example

Set the IP address while disconnected from the EtherNet/IP™ module (master).

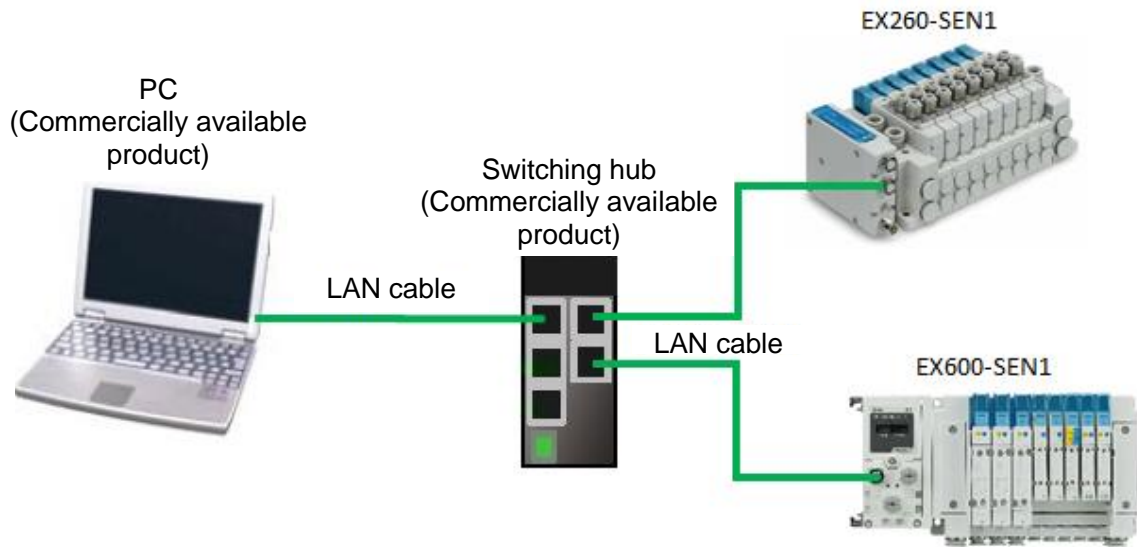
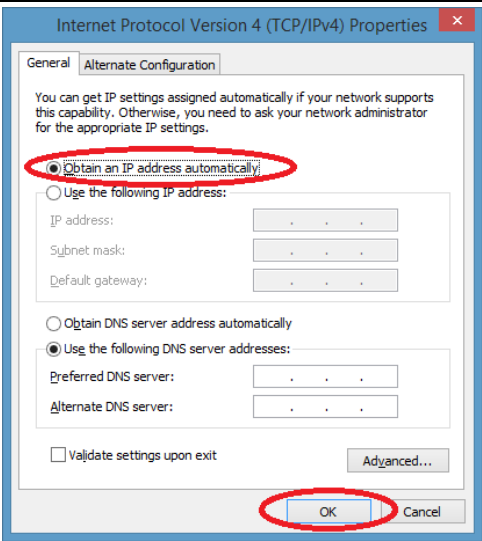
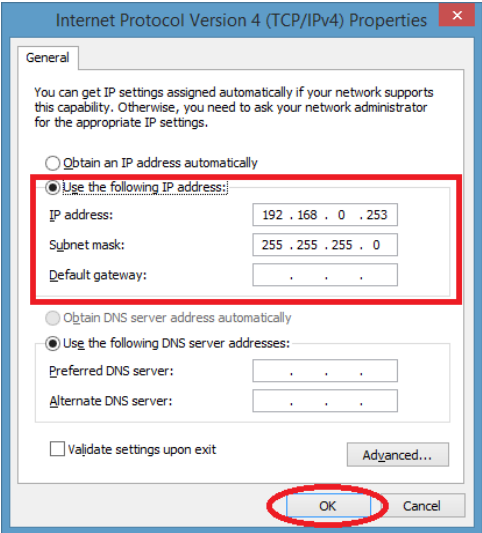

Fig. Network Configuration Example

4. Setting the Computer's IP Address

Set the IP address of the PC according to step 1 or 2 below.

No.	Display	Instructions
(1)		<p>[When a DHCP server is installed on the network] To automatically allocate the IP address using a DHCP server, in the "Internet Protocol Version 4 (TCP/IPv4) Properties" screen, in the "General" tab window, select "Obtain an IP address automatically", and click "OK".</p>
(2)		<p>[When a DHCP server is not installed on the network] To specify the IP address directly without a DHCP server, select "Use the following IP address" on the "Internet Protocol Version 4 (TCP/IPv4) Properties" screen, enter values in "IP address" and "Subnet mask," and then click "OK." Values that are entered in "IP address" and "Subnet mask" must be set according to the network used. *As an example in the left figure, IP address =192.168.0.253 Subnet mask =255.255.255.0 are entered.</p>

5. IP address setting of the IP Address Setting Tool

Set the IP address for the IP Address Setting Tool following the procedure (3) to (9) below.

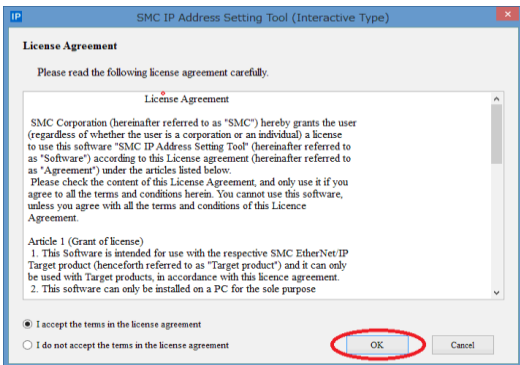
No.	Display	Instructions
(3)		<p>When the computer IP address has been set and the IP Address Setting Tool starts, the License agreement screen will appear. If the terms of the agreement are acceptable, select "I accept the terms in the license agreement" and click "OK".</p>

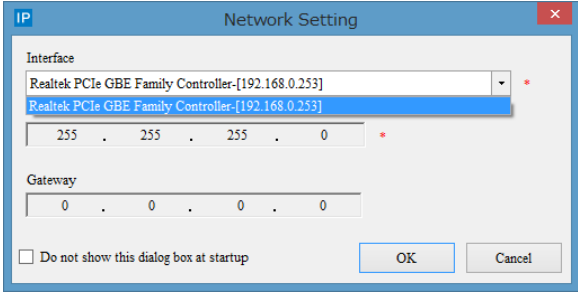
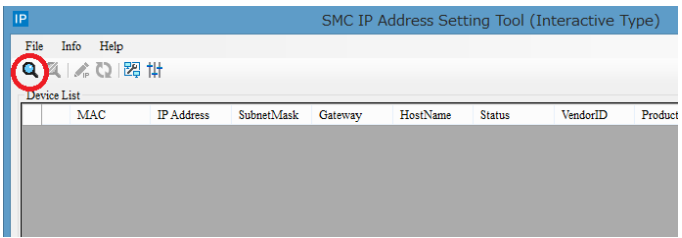
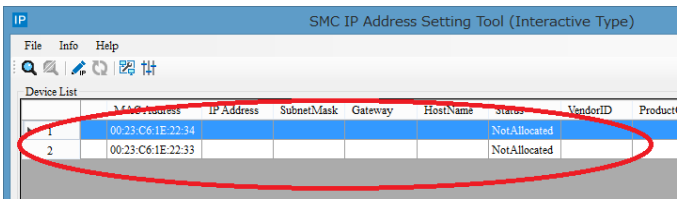
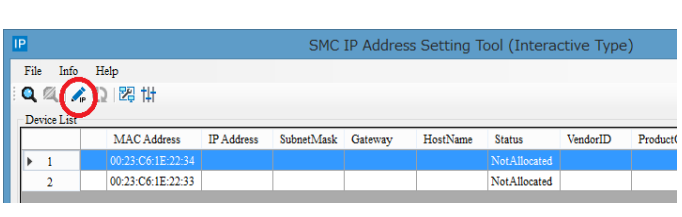
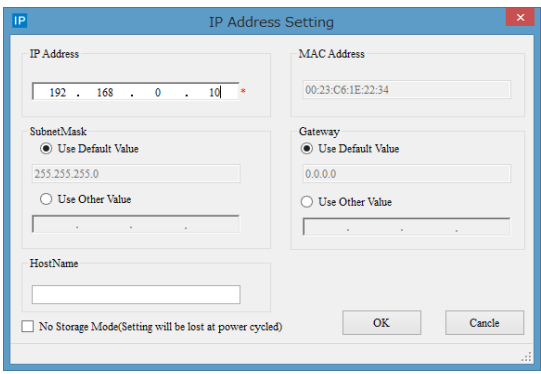
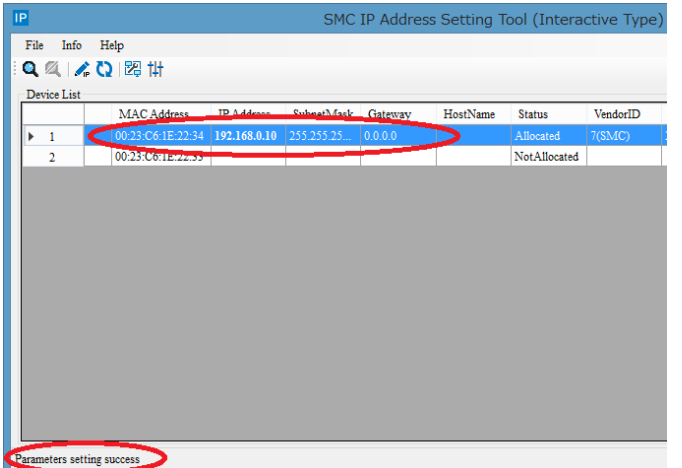
<p>(4)</p>		<p>The Network Setting screen starts. Select the network interface. If the screen does not need to appear the next time, tick the box for “Do not show this dialog box at startup” After selecting, click the [OK] button.</p>																											
<p>(5)</p>		<p>When the main screen appears, click “Scan” to check the connected unit.</p>																											
<p>(6)</p>	 <table border="1" data-bbox="240 754 924 952"> <thead> <tr> <th></th> <th>MAC</th> <th>IP Address</th> <th>Subnet.Mask</th> <th>Gateway</th> <th>HostName</th> <th>Status</th> <th>VendorID</th> <th>Product</th> </tr> </thead> <tbody> <tr> <td>1</td> <td>00:23:C6:1E:22:34</td> <td></td> <td></td> <td></td> <td></td> <td>NotAllocated</td> <td></td> <td></td> </tr> <tr> <td>2</td> <td>00:23:C6:1E:22:33</td> <td></td> <td></td> <td></td> <td></td> <td>NotAllocated</td> <td></td> <td></td> </tr> </tbody> </table>		MAC	IP Address	Subnet.Mask	Gateway	HostName	Status	VendorID	Product	1	00:23:C6:1E:22:34					NotAllocated			2	00:23:C6:1E:22:33					NotAllocated			<p>If the IP address is not set yet, only the MAC address will appear. *: When setting the IP address manually or it is not a compatible product, the MAC address will be grayed out.</p>
	MAC	IP Address	Subnet.Mask	Gateway	HostName	Status	VendorID	Product																					
1	00:23:C6:1E:22:34					NotAllocated																							
2	00:23:C6:1E:22:33					NotAllocated																							
<p>(7)</p>	 <table border="1" data-bbox="240 965 924 1180"> <thead> <tr> <th></th> <th>MAC Address</th> <th>IP Address</th> <th>Subnet.Mask</th> <th>Gateway</th> <th>HostName</th> <th>Status</th> <th>VendorID</th> <th>Product</th> </tr> </thead> <tbody> <tr> <td>1</td> <td>00:23:C6:1E:22:34</td> <td></td> <td></td> <td></td> <td></td> <td>NotAllocated</td> <td></td> <td></td> </tr> <tr> <td>2</td> <td>00:23:C6:1E:22:33</td> <td></td> <td></td> <td></td> <td></td> <td>NotAllocated</td> <td></td> <td></td> </tr> </tbody> </table>		MAC Address	IP Address	Subnet.Mask	Gateway	HostName	Status	VendorID	Product	1	00:23:C6:1E:22:34					NotAllocated			2	00:23:C6:1E:22:33					NotAllocated			<p>Select the item icon that shows the same MAC address number on the IP address setting tool as the MAC address on a label attached to the housing of the unit for which the IP address is to be set.</p>
	MAC Address	IP Address	Subnet.Mask	Gateway	HostName	Status	VendorID	Product																					
1	00:23:C6:1E:22:34					NotAllocated																							
2	00:23:C6:1E:22:33					NotAllocated																							
<p>(8)</p>		<p>When the setting screen appears, set the IP address, Subnet mask, and other items. After setting, click the [OK] button. When the IP address is not to be retained in Remote control mode, tick the box for “No storage Mode.”</p>																											
<p>(9)</p>	 <table border="1" data-bbox="240 1588 924 2054"> <thead> <tr> <th></th> <th>MAC Address</th> <th>IP Address</th> <th>Subnet.Mask</th> <th>Gateway</th> <th>HostName</th> <th>Status</th> <th>VendorID</th> <th>Product</th> </tr> </thead> <tbody> <tr> <td>1</td> <td>00:23:C6:1E:22:34</td> <td>192.168.0.10</td> <td>255.255.255.0</td> <td>0.0.0.0</td> <td></td> <td>Allocated</td> <td>7(SMC)</td> <td></td> </tr> <tr> <td>2</td> <td>00:23:C6:1E:22:33</td> <td></td> <td></td> <td></td> <td></td> <td>NotAllocated</td> <td></td> <td></td> </tr> </tbody> </table>		MAC Address	IP Address	Subnet.Mask	Gateway	HostName	Status	VendorID	Product	1	00:23:C6:1E:22:34	192.168.0.10	255.255.255.0	0.0.0.0		Allocated	7(SMC)		2	00:23:C6:1E:22:33					NotAllocated			<p>When setting is completed, the set values such as the IP address will appear. Also, "Parameters setting success" will appear in the bottom left. *: It is not possible to maintain the IP address (Storage Mode, Disable DHCP) while communicating with the EtherNet/IP™ module (master). Set the IP address while disconnected from the EtherNet/IP™ module (master).</p>
	MAC Address	IP Address	Subnet.Mask	Gateway	HostName	Status	VendorID	Product																					
1	00:23:C6:1E:22:34	192.168.0.10	255.255.255.0	0.0.0.0		Allocated	7(SMC)																						
2	00:23:C6:1E:22:33					NotAllocated																							

6. Option Setting

Set the optional function in accordance with steps 10 to 11 below.

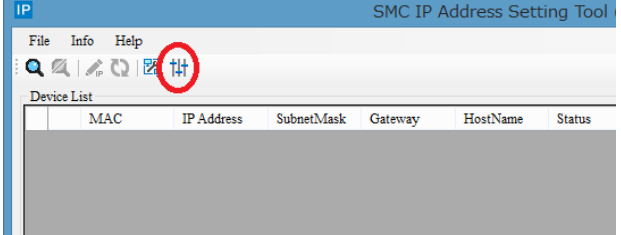
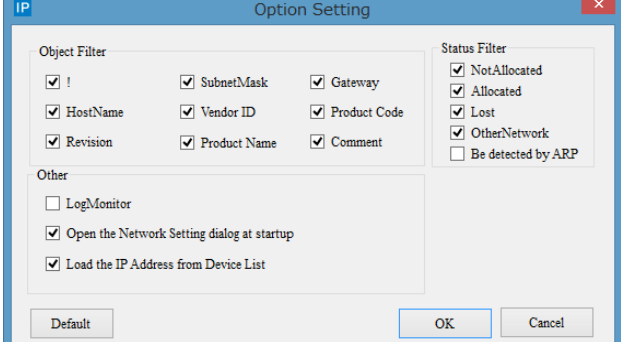
(10)		<p>Click “Option” to display the Option Setting screen.</p>
(11)		<p>The “Option Setting” screen is displayed. Items that are checked will function. Uncheck unnecessary items. The setting can be reset by clicking the “Default” button.</p>

7. Log monitor function

It is possible to monitor the scanned status using this tool.

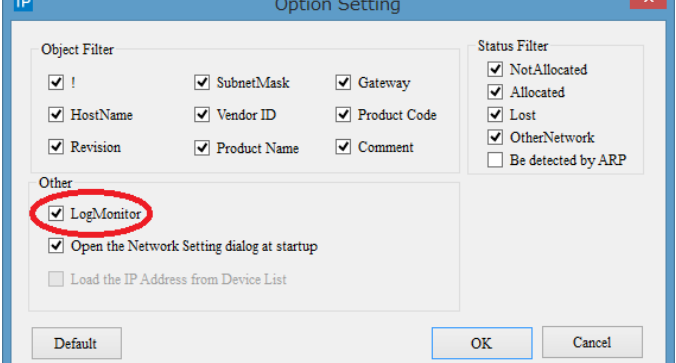
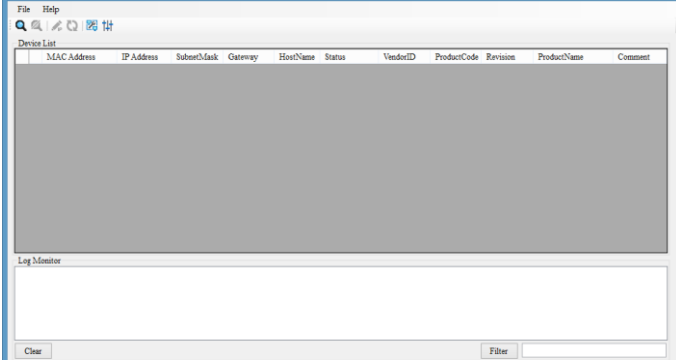
(12)		<p>Display the option screen and check the LogMonitor.</p>
(13)		<p>The Log Monitor window is displayed on the main screen.</p>

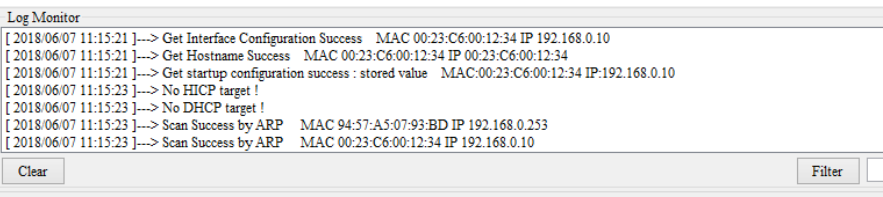
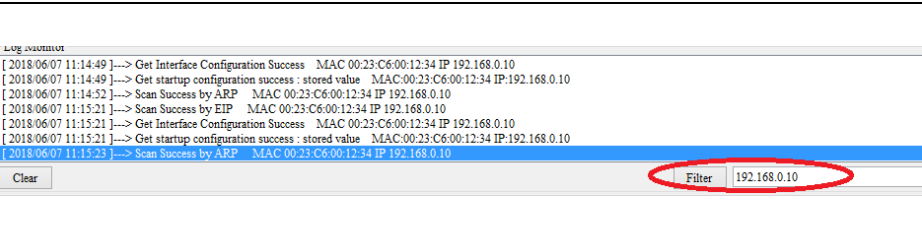
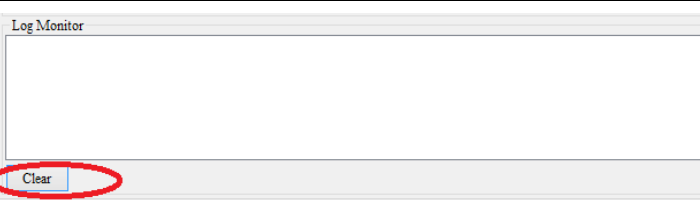
(14)		<p>When scanning or IP address setting is performed, the processed information is displayed as a log.</p>
(15)		<p>Enter a keyword to Filter the log, and click the Filter button. The line in which the entered keyword is shown is displayed.</p>
(16)		<p>To clear the Log Monitor information, click the Clear button. The display will be cleared.</p>

8. Export Function

This tool stores the scanned device list as a csv file.

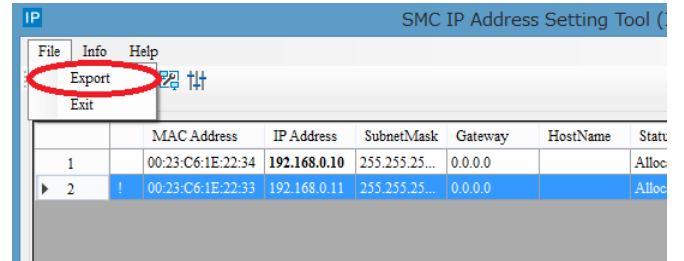
(17)	 <table border="1" data-bbox="263 1153 901 1288"> <thead> <tr> <th></th> <th>MAC Address</th> <th>IP Address</th> <th>SubnetMask</th> <th>Gateway</th> <th>HostName</th> <th>Statu</th> </tr> </thead> <tbody> <tr> <td>1</td> <td>00:23:C6:1E:22:34</td> <td>192.168.0.10</td> <td>255.255.25...</td> <td>0.0.0.0</td> <td></td> <td>Alloc</td> </tr> <tr> <td>2</td> <td>00:23:C6:1E:22:33</td> <td>192.168.0.11</td> <td>255.255.25...</td> <td>0.0.0.0</td> <td></td> <td>Alloc</td> </tr> </tbody> </table>		MAC Address	IP Address	SubnetMask	Gateway	HostName	Statu	1	00:23:C6:1E:22:34	192.168.0.10	255.255.25...	0.0.0.0		Alloc	2	00:23:C6:1E:22:33	192.168.0.11	255.255.25...	0.0.0.0		Alloc	<p>Click File > Export, and then save the csv file in the folder of your choice. The stored csv file can be used for the IP Setting Tool (presetting type).</p>
	MAC Address	IP Address	SubnetMask	Gateway	HostName	Statu																	
1	00:23:C6:1E:22:34	192.168.0.10	255.255.25...	0.0.0.0		Alloc																	
2	00:23:C6:1E:22:33	192.168.0.11	255.255.25...	0.0.0.0		Alloc																	

9. Definitions and Terminology (Supplementary Explanation)

Please refer to the table below for glossary.

	Terminology	Definition
D	DHCP	A protocol that automatically allocates information, necessary to be registered to use the network, such as an IP address, to individual devices connected to the TCP/IP network.
	DHCP mode	Mode to obtain an IP address from the DHCP Server. The IP address will be lost when the power supply is disconnected. Refer to the operation manual for setting the product.
	DHCP server	DHCP is an abbreviation of Dynamic Host Configuration Protocol. It is a server that automatically allocates information, necessary to be registered to use the network, such as an IP address, to individual devices on the network.
I	IP address	A 32 bit digit sequence which is assigned to identify devices which are connected to the network.
M	MAC address	A unique number assigned to all devices connected to an EtherNet/IP™ network.
R	Remote control mode	An IP address obtained via the DHCP server can be held. Refer to the operation manual for the products for setting.
S	Subnet mask	Numerical values that define the range of the numerical string within the IP address used on the network.
	Switching hub	Device that works as a relay in the network.

Revision history
A: Contents are added. [August 2018]

SMC Corporation

4-14-1, Sotokanda, Chiyoda-ku, Tokyo 101-0021 JAPAN

Tel: + 81 3 5207 8249 Fax: +81 3 5298 5362

URL <http://www.smcworld.com>

NOTE: Specifications are subject to change without prior notice and any obligation on the part of the manufacturer.

EtherNet/IP™ is a trademark of ODVA.

© 2018 SMC Corporation All Rights Reserved.

