



Communication Manual

THERMO-CON

Model No.

HEC001 series
HEC003 series
HEC012 series

HEC002 series
HEC006 series

Keep available whenever necessary.

This manual is copyrighted and all rights are reserved by SMC Corporation, and may not, in whole or in part, be copied, photocopied or translated without prior written consent of SMC.

History

Version	Preface	Contents	Chap.1	Chap.2	Chap.3	Chap.4	Chap.5	Chap.6
1.0								
1.1								

Record of Changes

Version	Contents	Date
1.0	First edition	June.2006
1.1	The series name is added to the cover.The product photography of the cover is deleted.	May.2010

Preface

Thank you very much for purchasing SMC Thermo-con.

This manual contains description for communication of this product for your full benefit from this product.

Read the operation manual carefully before use of this product, and understand the outline of the product and safety instructions well. Instructions in the categories, “Danger”, “Warning” and “Caution”, are important for safety and must be duly followed.

Please contact the following for any question and unclear points regarding the Thermo-con.

SMC Corporation R&D Center
Product Development Division-6
Address: 4-2-2, KINUNODAI, TSUKUBAMIRAI-CITY , IBARAKI-KEN 300-2493, JAPAN
Phone: +81-297-52-6666
Fax: +81-297-20-5007
E-mail: kaihatsu_6_g3@smcjpn.co.jp

Notice: The content of this manual can be revised without a previous notice.

CONTENTS

	Pages
1 Preparation for Communication -----	1-1
2 Specifications of Communication Method -----	2-1
3 Communication Format-----	3-1
3.1 Control code used for communication -----	3-1
3.2 Command code list-----	3-1
3.3 Communication procedures and format -----	3-2
3.4 Calculation of checksum -----	3-3
4 Details of Communication format -----	4-1
4.1 Temperature setting (without writing EEPROM)-----	4-1
4.2 Reading setting temperature-----	4-1
4.3 Reading internal sensor-----	4-2
4.4 Reading external sensor -----	4-3
4.5 Reading alarm status -----	4-3
4.6 Reading temperature average data-----	4-5
4.7 Offset setting (without writing EEPROM)-----	4-5
4.8 Reading offset -----	4-5
4.9 Temperature setting (with writing EEPROM)-----	4-6
4.10 Offset setting (with writing EEPROM) -----	4-7
5 Troubleshooting-----	5-1
6 Communication Format and	
Examples of Answers from Thermo-con-----	6-1

1 Preparation for Communication

Make preparation for using communication facility as follows.

- 1) Turn off the power switch of Thermo-con.
- 2) Connect communication cable to communication connector (RS-485 of RS-232C) of Thermo-con.
 - Use twist pair shield cable as communication cable.
 - Connect the host and thermo-con with the cross cable for RS-232C and the straight cable for RS-485.
 - Connect shielded cable of communication cable to communication connector and drop it to FG(flame ground).
 - Connection drawing for communication is shown in the Figures 1-1 and 1-2.
 - Length of communication cable for RS-485 shall be limited to around 500[m] in total, and that for RS-232C shall be 15[m].
 - If communication cable for RS-485 is longer, connect terminating resistance ($220\ \Omega$, 1/2w) to each + and - terminal of the host computer and the farthest Thermo-con.
- 3) Turn on the power switch of Thermo-con.
- 4) Select communication types for all Thermo-cons. See the operation manual of the details.
- 5) That's all for preparation of communication. Then if a communication command from the host computer is given, each Thermo-con will reply it.

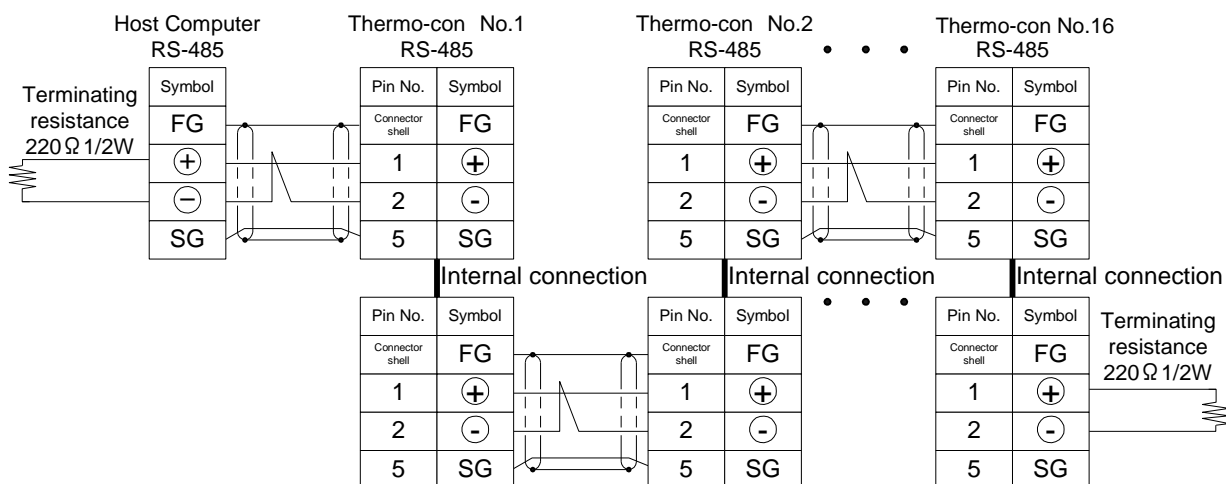

Figure1-1 Communication Connection (RS-485)

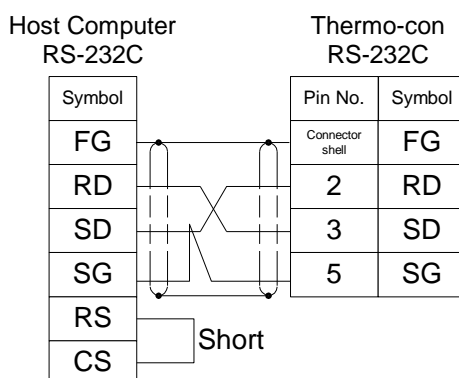

Figure1-2 Communication Connection (RS-232C)

2 Specifications of Communication Method

• Standards	RS-485 or RS-232C
• Circuit type	Half duplex
• Communication type	Asynchronous
• Communication speed	Changeable, 600, <u>1200</u> , 2400, 4800, 9600, 19200 bps
• Character code	ASCII
• Parity	Select, <u>Nil</u> , even number, odd number
• Start bit	1 bit
• Data length	Select 7 bit or <u>8 bit</u> .
• Stop bit	Select <u>1 bit</u> or 2 bit.
• Block check	Sum check

Note: Values underlined indicate default values at all reset.
It is set to these values when delivered.

3 Communication Format

3.1 Control code used for communication

Control code	ASCII code
ENQ	05H
STX	02H
ETX	03H
ACK	06H
CR	0DH
SOH	01H

- "H" of ASCII code indicates hexa code.

3.2 Command code list

Command code (COM)	Contents
31H	Set temperature (without writing EEPROM) and read
32H	Read internal sensor
33H	Read external sensor
34H	Read alarm status
35H	Read temperature average data (It is same as reading external sensor in this model.)
36H	Set offset (without writing EEPROM) and read
37H	Set temperature (with writing EEPROM)
38H	Set offset (with writing EEPROM)

3.3 Communication procedures and format

The host computer has the initiative of sequence. Sequence always starts from the host computer and each Thermo-con replies it.

If communication data is processed normally, the Thermo-con returns specified response and if processing communication data is failed, no response is returned.

When no response is returned to the host computer from the Thermo-con even if waiting for 3 sec., resend the data. The Thermo-con returns response after waiting for 50 msec.

For communication of plural number of communication data, wait until the return message is received from the thermo-con to send the next communication data. It sometimes cannot return the messages properly when the communication data is received successively.

Selection of Unit Specification

- There are two cases in communication format, which are specifying unit No. and not.
- When one Thermo-con is used, select “without specifying unit” and when two or more Thermo-cons are used, select “ with specifying unit”.
- When several Thermo-con are used with without specified unit No., correct control is not realized due to data conflict.
- In the case of use with specified unit No., ensure to coincide communication No. and each Thermo-con unit No.

(1) Setting Change

Host →

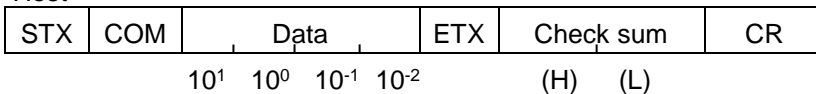

← Thermo-con

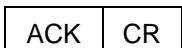

<Specifying unit>

Host →

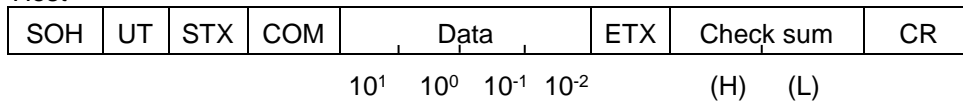

← Thermo-con

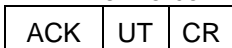

(2) Confirming and reading

Host →

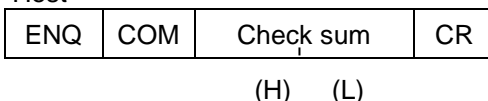

← Thermo-con

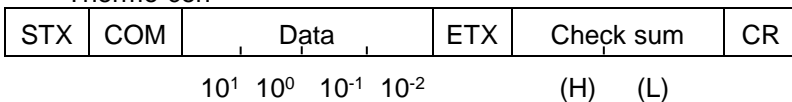

Host →

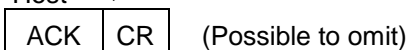

<Specifying unit>

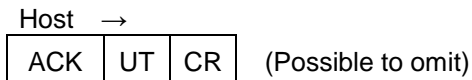
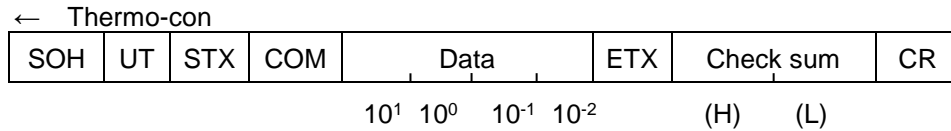
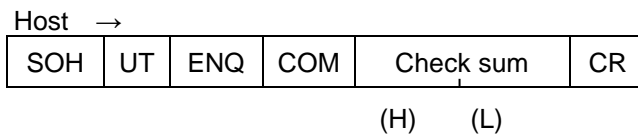

- COM indicates communication command.
- UT indicates unit No. of each Thermo-con. Unit No. is the No. to identify each Thermo-cons when 2 or more Thermo-cons are linked by communication. Set this No. with second mode of Thermo-con within O-F. (UT is the code adding 30H to unit No.. 30H---3FH.)
- As for symbols at communication, minus is indicated by “-“ (2DH by ASCII code) and plus is indicated by “0” (30H by ASCII code).
- In case of setting temperature and offset with communication, data out of set range isn't memorised. (If communication format is correct, ACK returns.)
- When writing in EEPROM is specified, changed data is memorized in EEPROM each time. Since writing life of EEPROM is (approx. 1 million times), EEPROM is changed only when data is changed.

3.4 Calculation of Check Sum

Calculation range ----- From the second byte to ETX
when there is no ETX, add before check sum.

Calculating method-----Take out the lower 1 byte of the total.

eg.) Set temperature to 30 deg.C (without unit specified)

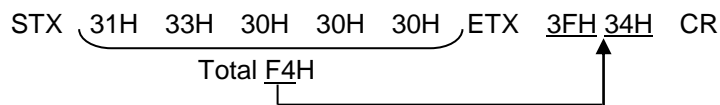

eg.) Read Thermo-con internal sensor of unit No.2

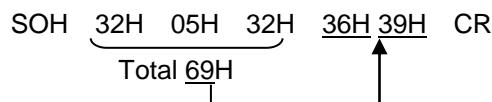

Note) Check sum is not ASCII code.

Data of UT and Check Sum

Character data	0...9	A	B	C	D	E	F
ASCII	30H...39H	41H	42H	43H	44H	45H	46H
UT and check sum	30H...39H(ditto)	3AH	3BH	3CH	3DH	3EH	3FH

4 Details of Communication Format

4-1 Temperature setting (without writing EEPROM)

The host computer sets temperature of each Thermo-con. In this command, temperature setting data is not written in EEPROM. This data is invalidated by turning off power.

The setting range is from 10.0 to 60.0 deg.C. As 0.1 deg.C is the minimum unit, the number in the hundredths place (10^{-2}) should always be 0 (=30H). (When the value at every 0.01deg.C is input, it is rounded off.)

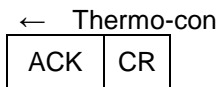
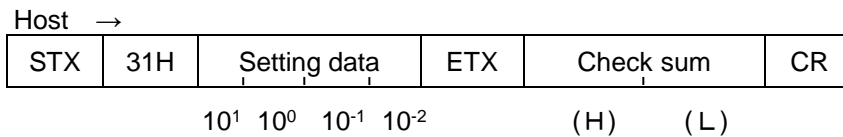

<Specifying unit>

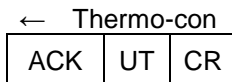
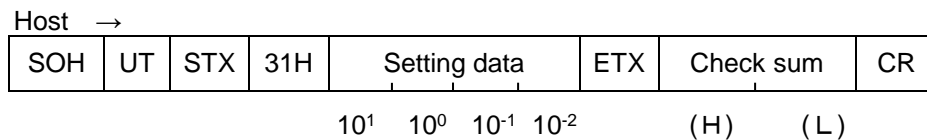

4-2 Reading setting temperature

As 0.1 deg.C is the minimum unit, the number in the hundredths place (10^{-2}) is always 0 (=30H).

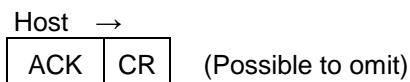
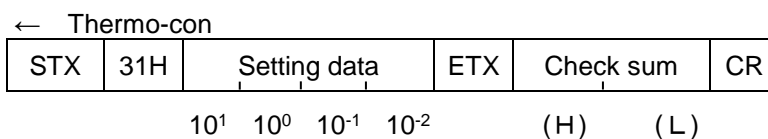
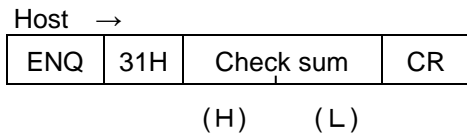

<Specifying unit>

Host →

SOH	UT	ENQ	31H	Check sum	CR
-----	----	-----	-----	-----------	----

(H) (L)

← Thermo-con

SOH	UT	STX	31H	Setting data	ETX	Check sum	CR
-----	----	-----	-----	--------------	-----	-----------	----

10¹ 10⁰ 10⁻¹ 10⁻² (H) (L)

Host →

ACK	UT	CR
-----	----	----

(Possible to omit)

4-3 Reading internal sensor

As the minimum unit is 0.01 deg.C, the value in the hundredths place can be read.

Host →

ENQ	32H	Check sum	CR
-----	-----	-----------	----

(H) (L)

← Thermo-con

STX	32H	Internal sensor	ETX	Check sum	CR
-----	-----	-----------------	-----	-----------	----

10¹ 10⁰ 10⁻¹ 10⁻² (H) (L)

Host →

ACK	CR
-----	----

(Possible to omit)

Note) 2DH is entered in 10¹ digit "-" is attached to temperature data.

<Specifying unit>

Host →

SOH	UT	ENQ	32H	Check sum	CR
-----	----	-----	-----	-----------	----

(H) (L)

← Thermo-con

SOH	UT	STX	32H	Internal sensor	ETX	Check sum	CR
-----	----	-----	-----	-----------------	-----	-----------	----

10¹ 10⁰ 10⁻¹ 10⁻² (H) (L)

Host →

ACK	UT	CR
-----	----	----

(Possible to omit)

Note) 2DH is entered in 10¹ digit "-" is attached to temperature data.

4-4 Reading external sensor

As the minimum unit is 0.01 deg.C, the value in the hundredths place can be read.

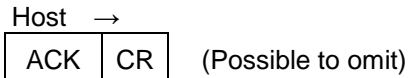
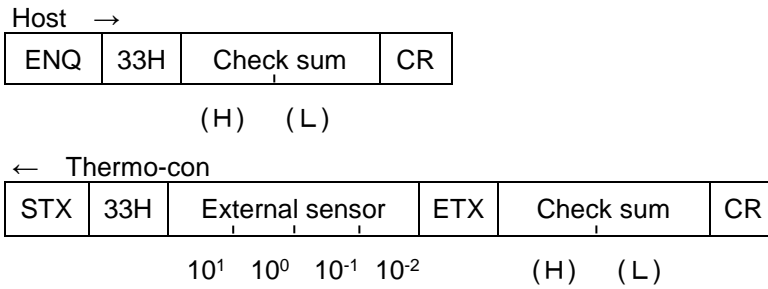

Note) 2DH is entered in 10^1 digit "-" is attached to temperature data.

<Specifying unit>

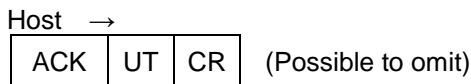
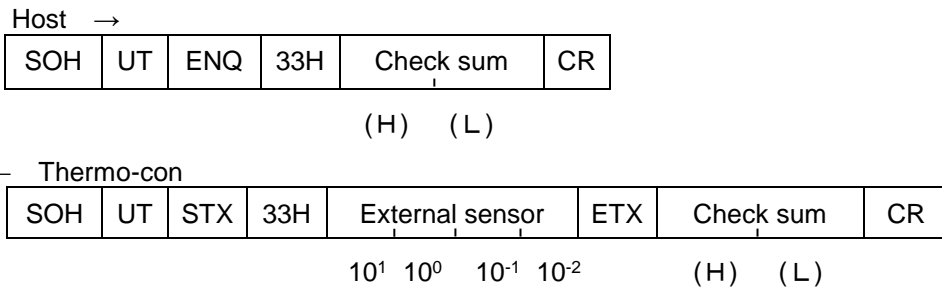

Note) 2DH is entered in 10^1 digit "-" is attached to temperature data.

4-5 Reading alarm status

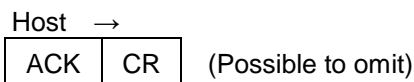
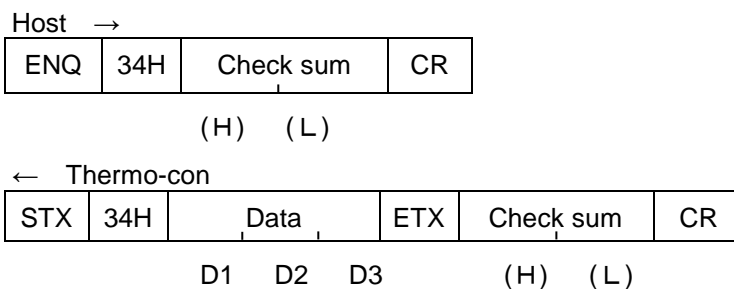

<Specifying unit>

Host →

SOH	UT	ENQ	34H	Check sum	CR
-----	----	-----	-----	-----------	----

(H) (L)

← Thermo-con

SOH	UT	STX	34H	Data	ETX	Check sum	CR
-----	----	-----	-----	------	-----	-----------	----

D1 D2 D3 (H) (L)

Host →

ACK	UT	CR
-----	----	----

(Possible to omit)

Data (D1, D2, D3) changes following bit line to ASCII code. (1 is for ON, 0 is for OFF)

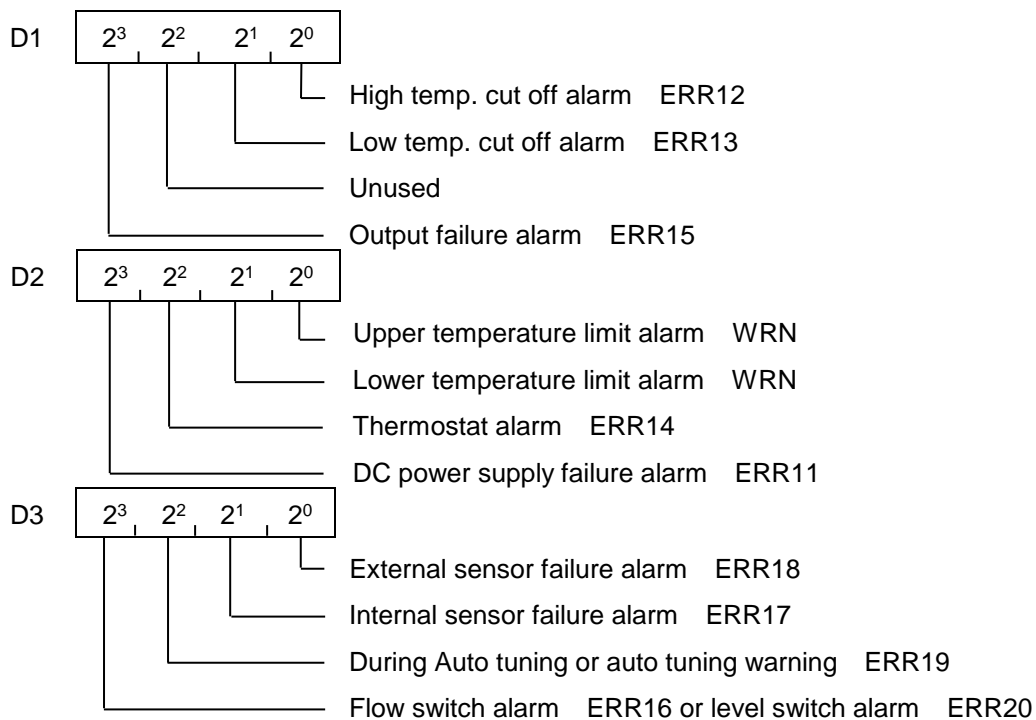

When some alarms/warnings go off at the same time, D1 to D3 reaches the added value.

Ex. When the “Upper temperature limit alarm” and the “DC power voltage alarm” go off simultaneously, D2 will be $2^3 \times 1 + 2^2 \times 0 + 2^1 \times 0 + 2^0 \times 1 = 9 (=39H)$.

4-6 Reading temperature average data

Note) For this product, the average temperature data, Tm, indicates the temperature of the external sensor. Refer to “4-4 Reading external sensor” for the format.

4-7 Offset setting (without writing EEPROM)

Set offset of each Thermo-con from host. In this command, offset data loses effect with furning power to OFF because it isn't memorized into EEPROM.

It can be set at a minimum of every 0.01 deg.C.

Host →

STX	36H		Offset		ETX	Check sum		CR
		Symbol	10 ⁰ 10 ⁻¹ 10 ⁻²		(H)	(L)		

← Thermo-con

ACK	CR
-----	----

Note)As for symbols, minus is indicated by “-“(=2DH) and plus is indicated by “0“(=30H).

<Specifying unit>

Host →

SOH	UT	STX	36H		Offset		ETX	Check sum		CR
				Symbol	10 ⁰ 10 ⁻¹ 10 ⁻²		(H)	(L)		

← Thermo-con

ACK	UT	CR
-----	----	----

Note)As for symbols, minus is indicated by “-“(=2DH) and plus is indicated by “0“(=30H).

4-8 Reading offset

As the minimum unit is 0.01 deg.C, the value in the hundredths place can be read.

Host →

ENQ	36H	Check sum	CR
		(H)	(L)

← Thermo-con

STX	36H		Offset		ETX	Check sum		CR
		Symbol	10 ⁰ 10 ⁻¹ 10 ⁻²		(H)	(L)		

Host →

ACK	CR	(Possible to omit)
-----	----	--------------------

Note) As for symbols, minus is indicated by “-“(=2DH) and plus is indicated by “0“(=30H).

<Specifying unit>

Host →

SOH	UT	ENQ	36H	Check sum	CR
-----	----	-----	-----	-----------	----

(H) (L)

← Thermo-con

SOH	UT	STX	36H	Offset	ETX	Check sum	CR
-----	----	-----	-----	--------	-----	-----------	----

Symbol 10⁰ 10⁻¹ 10⁻² (H) (L)

Host →

ACK	UT	CR
-----	----	----

(Possible to omit)

Note) As for symbols, minus is indicated by “-”(=2DH) and plus is indicated by “0”(=30H).

4-9 Temperature setting (with writing EEPROM)

The host computer sets temperature of each Thermo-con. In this command, temperature setting data is written in EEPROM.

The setting range is from 10.0 to 60.0 deg.C. As 0.1 deg.C is the minimum unit, the number in the hundredths place (10⁻²) should always be 0 (=30H). (When the value at every 0.01deg.C is input, it is rounded off.)

Host →

STX	37H	Setting data	ETX	Check sum	CR
-----	-----	--------------	-----	-----------	----

10¹ 10⁰ 10⁻¹ 10⁻² (H) (L)

← Thermo-con

ACK	CR
-----	----

<Specifying unit>

Host →

SOH	UT	STX	37H	Setting data	ETX	Check sum	CR
-----	----	-----	-----	--------------	-----	-----------	----

10¹ 10⁰ 10⁻¹ 10⁻² (H) (L)

← Thermo-con

ACK	UT	CR
-----	----	----

5 Troubleshooting

The table below shows the solutions for the problems.

Problem	Cause	Solution
Communication cannot be made.	A wrong connecting cable is used.	Connect the host and the thermo-con with the following cables: A cross cable for RS-232C A straight cable for RS-485
	The settings of the host and thermo-con are not consistent with each others.	Make the following settings of the host and the thermo-con consistent: Unit Number, Baud Rate, Parity Bit, Data Length, Stop Bit
	The program is incorrect.	Ensure that the program is made properly according to this operation manual. (Control code, command code, checksum, etc.)
	The communication method is incorrect.	Use the communication method suitable for the specification of the thermo-con (RS-485, RS-232C).
	It is influenced by the noise from outside.	Use a shield wire for the cable, and ground the shield to the field ground.
	It is influenced by the reflected wave.	Install a terminating resistance.
Temperature cannot be set.	Four digits are not input for the setting temperature.	Input four digits for the setting temperature. As 0.1 deg.C is the minimum indication unit, input 0 (=30H) in the hundredths place.
	Value out of the setting range is input.	Set it within the temperature setting range (between 10.0 and 60.0 deg.C).
Communication cannot be continued.	It exceeds the writable capacity of EEPROM (approx. 1 million times).	Ask SMC for repair.
	The connecting cable comes off or broken.	Check the connecting cable.
The thermo-con does not give a correct answer.	The host sends more than one communication data successively.	When sending communication data, wait until an answer from the thermo-con is received to send the next data.

6 Communication Format and Examples of Answers from Thermo-con

Examples of commands and answers from the thermo-con (unit unspecified)

Command code ASCII	Command	Unit specified	Host requirement	Answer from thermo-con	Content
31	Reading setting temperature	No	05 31 33 31 0D	02 31 32 35 30 30 03 3F 38 0D	Answer "25.0 deg.C."
31	Temperature setting (without writing EEPROM)	No	02 31 32 35 30 30 03 3F 38 0D	06 0D	Set at 25.0 deg.C
32	Reading internal sensor	No	05 32 33 32 0D	02 32 32 35 30 32 03 3F 3B 0D	Answer "25.02 deg.C"
33	Reading external sensor	No	05 33 33 33 0D	02 33 33 30 30 32 03 3F 38 0D	Answer "30.02 deg.C"
34	Reading alarm status	No	05 34 33 34 0D	02 34 30 38 30 03 3C 3C 0D	Answer "ERR11"
36	Reading offset Offset setting (without writing EEPROM)	No No	05 36 33 36 0D 02 36 30 31 35 30 03 3F3C 0D	02 36 2D 31 35 32 03 3F 3B 0D 06 0D	Answer "-1.52 deg.C" Set at +1.50 deg.C
37	Temperature setting (with writing EEPROM)	No	02 37 32 35 30 30 03 3F3E 0D	06 0D	Set at 25.0 deg.C
38	Offset setting (with writing EEPROM)	No	02 38 30 31 35 30 03 3F3E 0D	06 0D	Set at +1.50 deg.C

Examples of commands and answers from the thermo-con (unit specified)

Command code ASCII	Command	Unit specified	Host requirement	Answer from thermo-con	Content
31	Reading setting temperature	2	01 32 05 31 36 38 0D	01 32 02 31 32 35 30 30 03 32 3C 0D	Answer "25.0 deg.C"
31	Temperature setting (without writing EEPROM)	2	01 32 02 31 32 35 30 30 03 32 3C 0D	06 32 0D	Set at 25.0 deg.C
32	Reading internal sensor	2	01 32 05 32 36 39 0D	01 32 02 32 32 35 30 32 03 32 3F 0D	Answer "25.02 deg.C"
33	Reading external sensor	2	01 32 05 33 36 3A 0D	01 32 02 33 33 30 30 32 03 32 3C 0D	Answer "30.02 deg.C"
34	Reading alarm status	2	01 32 05 34 36 3B 0D	01 32 02 34 30 38 30 03 30 30 0D	Answer "ERR11"
36	Reading offset Offset setting (without writing EEPROM)	2 2	01 32 05 36 36 3D 0D 01 32 02 36 30 31 35 30 03 33 30 0D	01 32 02 36 2D 31 35 32 03 32 3F 0D 06 32 0D	Answer "-1.52 deg.C" Set at +1.50 deg.C
37	Temperature setting (with writing EEPROM)	F	01 3F 02 37 32 35 30 30 03 33 3F 0D	06 3F 0D	Set at 25.0 deg.C
38	Offset setting (with writing EEPROM)	F	01 3F 02 38 30 31 35 30 03 33 3F 0D	06 3F 0D	Set at +1.50 deg.C